

MODEL 23A, B, C, S

4mm Square

Sealed Single Turn

Surface Mount

Cermet Trimming

Potentiometer

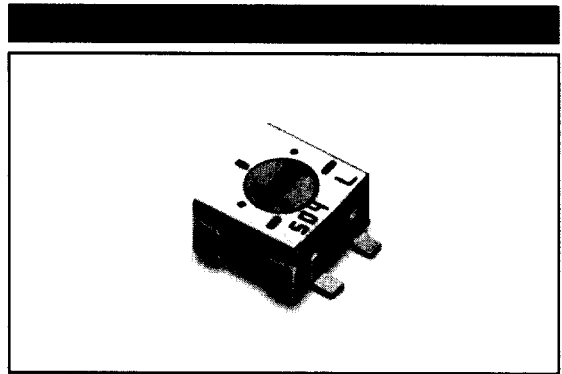

1

ELECTRICAL

Standard Resistance Range, Ohms	100 to 2Meg
Standard Resistance Tolerance	±20%
Input Voltage, Maximum	200 Vdc or rms not to exceed power rating
Power Rating, Watts	0.25 at 70°C derating to 0 at 125°C
End Resistance, Maximum	1% or 3 Ohms, whichever is greater
Actual Electrical Travel, Nominal	200°
Dielectric Strength	500 Vrms
Insulation Resistance, Minimum	100 Megohms
Resolution	Essentially infinite
Contact Resistance Variation, Maximum	2% or 3 Ohms, whichever is greater

ENVIRONMENTAL

Seal	85°C Fluorinert® (No Leaks)
Temperature Coefficient, Maximum	±100ppm/°C (<200 Ohms, >1Meg = ±250ppm/°C)
Operating Temperature Range	-55°C to +125°C
Thermal Shock	5 cycles, -55°C to +125°C (2% ΔRT, 2% ΔVR)
Moisture Resistance	Ten 24 hour cycles (3% ΔRT)
Shock, 6ms Sawtooth	100G's (1% ΔRT, 1% ΔVR)
Vibration	20G's, 10 to 2,000 Hz (1% ΔRT, 1% ΔVR)
High Temperature Exposure	250 hours at 125°C (2% ΔRT, 2% ΔVR)
Rotational Life	100 cycles (5% ΔRT)
Load Life at 0.25 Watts	1,000 hours at 70°C (3% ΔRT, 1% ΔVR)
Resistance to Solder Heat	260°C for 10 sec. (1% ΔRT)

MECHANICAL

Mechanical Stops	Solid
Stop Strength, Minimum	4 oz.-in. (300 gr-cm)
Torque, Maximum	2 oz.-in. (150 gr-cm)
Weight, Nominal	.005 oz. (0.14 grams)

Fluorinert® is a registered trademark of 3M Company.
Specifications subject to change without notice.

TOP ADJUSTMENT (Inch/mm)

Model 23A - J Hook

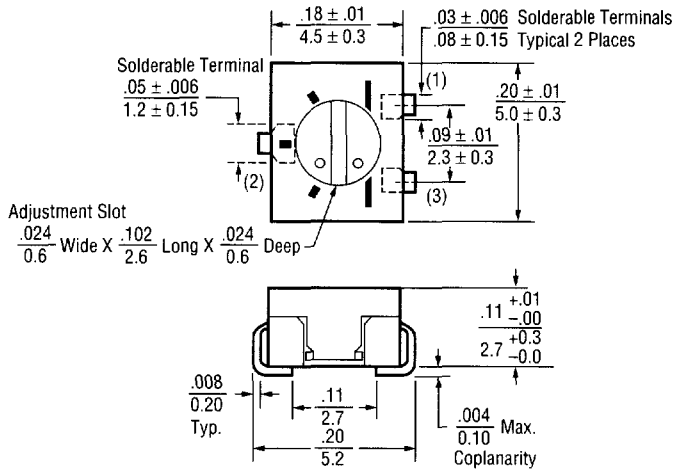

TOP ADJUSTMENT (Inch/mm)

Model 23B - Gull Wing

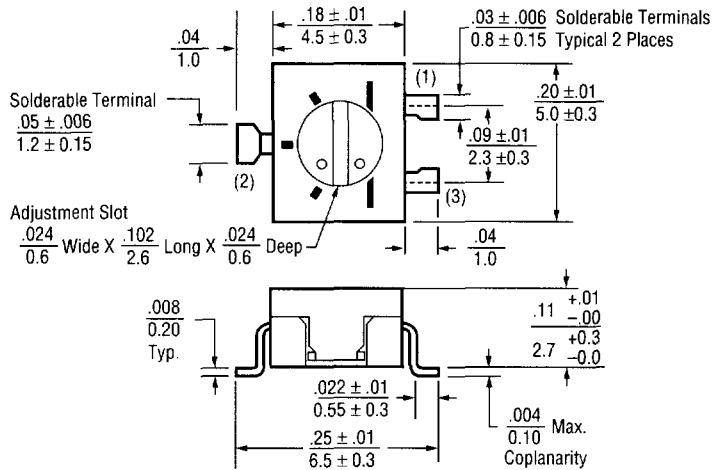

SIDE ADJUSTMENT (Inch/mm)

Model 23S

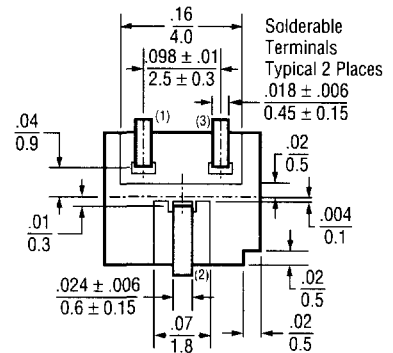
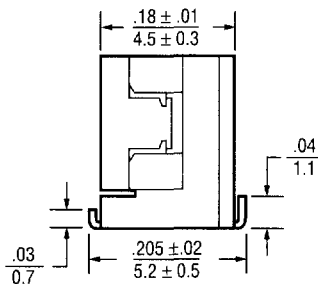
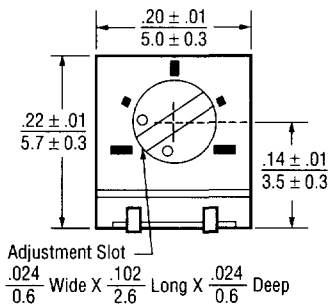

THROUGH HOLE (Inch/mm)

Model 23C

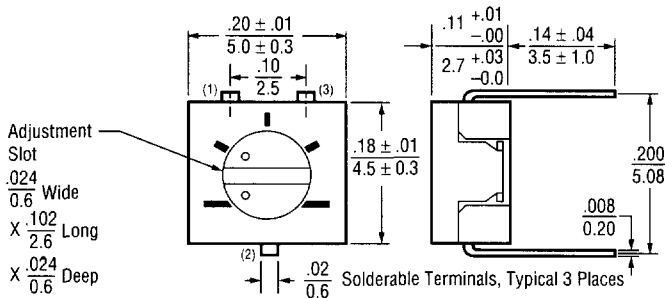

Note: Bottom adjustment version available - consult factory.

RECOMMENDED PCB LAYOUT (Inch/mm)

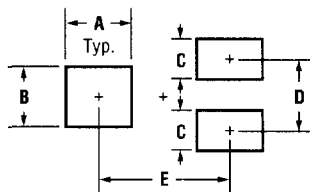

Dim.	23A	23S	23B
A	.08 2.0	.069 1.75	.05 1.3
B	.08 2.0	.06 1.6	.08 2.0
C	.05 1.3	.047 1.2	.05 1.3
D	.09 2.3	.09 2.3	.09 2.3
E	.16 4.1	.16 4.1	.22 5.5

STANDARD RESISTANCE VALUES, OHMS

100	1K	10K	100K	1Meg
200	2K	20K	200K	2Meg
500	5K	50K	500K	

PACKAGING

Standard: Boxes
Capacity = 100 Units

Option: Embossed Tape
All units oriented with #2 (slider) terminal adjacent to sprocket holes.

	Pin Style	=	A,B	S
Tape	Width	=	12 mm	12 mm
	Sprocket	=	4 mm Pitch	4 mm Pitch
	Capacity	=	500 Units	750 Units
Reel	Diameter	=	7" (178 mm)	10" (254 mm)

ORDERING INFORMATION

Standard:

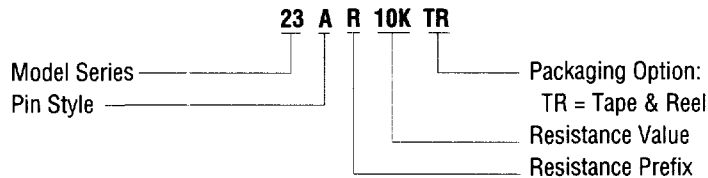

CIRCUIT DIAGRAM

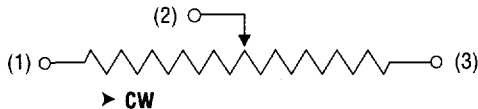

NOTES

English equivalents are based on 1 inch = 25.4mm and are provided for general information only.

Tolerances unless otherwise specified:
Linear = ± 0.3 mm (.01 inches)

