

C&K Y Series 4 & 6 Tumbler Switchlocks



Features/Benefits

- **Anti-static switch**—exceeds 20 KV DC static resistance
- **Momentary models available**
- **Miniature profile**
- **Wire leads and harnesses available**

Typical Applications

- **Point-of-sale terminals**
- **Cash registers**
- **Computers**

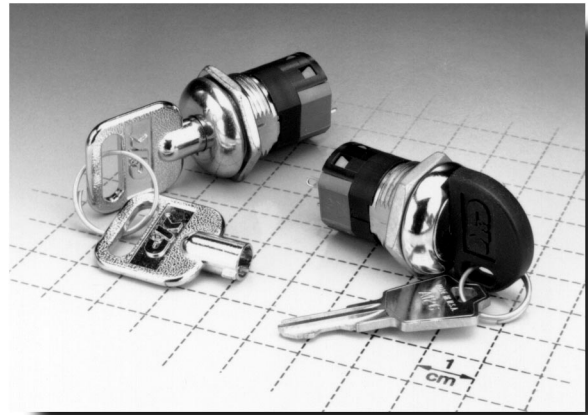

Build-A-Switch

Our easy Build-A-Switch concept allows you to mix and match options to create the switch you need. Below is a complete listing of options shown in catalog. To order, simply select desired option from each category and place in the appropriate box. Switchlocks with standard options are shown on page H-4. Available options are shown and described on pages H-5 thru H-10. For additional options not shown in catalog, consult Customer Service Center.

Typical Example: **Y 1 0 0 1 3** — **2** — **C** — **2** — **0 3** — **N** — **Q** — —

<p>Switch and Lock Function</p> <p>Y10013 (STD.) SP, 45° Index Y1011U (STD.) SP, 90° Index Y20013 DP, 45° Index Y1001C SP, 45° Index Y2001C DP, 45° Index Y1001U SP, 45° Index Y2001U DP, 45° Index Y10082 SP, 45° Index Y20082 DP, 45° Index Y100AA SP, 45° Index Y200AA DP, 45° Index Y100AB SP, 45° Index Y10113 SP, 90° Index Y20113 DP, 90° Index Y1011C SP, 90° Index Y2011C DP, 90° Index Y2011U DP, 90° Index Y14173 SP, 90° Index Y1417C SP, 90° Index Y1417U SP, 90° Index Y10812 SP, 45° Index, mom. Y20812 DP, 45° Index, mom. Y10882 SP, 45° Index, mom. Y20882 DP, 45° Index, mom. Y108AD SP, 45° Index, mom. Y208AD DP, 45° Index, mom. Y108AH SP, 45° Index, mom. Y208AH DP, 45° Index, mom. Y108AJ SP, 45° Index, mom. Y208AJ DP, 45° Index, mom. Y19073 SP w/common, 90° Index Y1907C SP w/common, 90° Index Y1907U SP w/common, 90° Index Y19001 SP w/common, 90° Index Y1900A SP w/common, 90° Index Y1900S SP w/common, 90° Index</p>	<p>Keying</p> <p>2 (STD.) Two nickel plated brass keys (4 tumbler) or two die cast zinc alloy keys with chrome plating (6 tumbler) J One nickel plated brass key with plastic insert molded round head and one nickel plated brass key T One nickel plated brass key with plastic insert molded square head and one nickel plated brass key</p> <p>Lock Type</p> <p>A (STD.) 4 Tumbler lock (YX08 models) C (STD.) 4 Tumbler lock with detent V (STD.) 6 Tumbler tubular lock N 4 Tumbler lock with anti-static switch (YX08 models) R 4 Tumbler lock with detent and anti-static switch W 6 Tumbler tubular lock with anti-static switch</p> <p>Lock Finish</p> <p>2 (STD.) Stainless steel facing 1 Nickel with removable dress nut 4 Polished nickel with removable dress nut 8 Gloss black facing F Polished nickel facing</p> <p>Terminations</p> <p>03 (STD.) Solder lug with hole 01 Solder lug with notch 02 PC Thru-hole 07 Solder lug with hole (Y190XX models only) WC Wire lead</p>	<p>Mounting/Lock Style</p> <p>N (STD.) With nut D With clip L With removable dress nut and latch pawl R With removable dress nut</p> <p>Contact Material</p> <p>Q (STD.) Silver B Gold G Gold over silver</p> <p>Seal</p> <p>NONE (STD.) No seal E Epoxy seal</p>	<p>Key Color</p> <p>NONE (STD.) Nickel plated brass or chrome plated zinc alloy</p> <p>1 White 2 Black 3 Red T Beige</p>
--	---	---	---

C&K Y Series 4 & 6 Tumbler Switchlocks



Switchlock

Specifications

CONTACT RATING: Q contact material: 4 AMPS @ 125 V AC or 28 V DC; 2 AMPS @ 250 V AC (UL/CSA). See page H-10 for additional ratings.

ELECTRICAL LIFE: 10,000 make-and-break cycles at full load.

CONTACT RESISTANCE: Below 10 milliohms typ. initial @ 2-4 V DC, 100 mA, for both silver and gold plated contacts.

INSULATION RESISTANCE: 10^9 ohms min.

DIELECTRIC STRENGTH: 1,000 V RMS min. @ sea level.

INDEXING: 45° or 90°, 2-4 positions (4&5 tumbler switchlocks).
45°, 3 positions; or 90°, 2 positions (6 tumbler tubular switchlocks).
Other functions available, consult Customer Service Center.

STATIC RESISTANCE: Anti-static models exceed 20 KV DC static resistance @ sea level, lock body to terminals.

Materials

LOCK: Zinc alloy with stainless steel facing, std. (4 tumbler lock and 6 tumbler tubular lock).

KEYS: Two nickel plated brass keys, with code number, std. (4 tumbler lock). Two die cast chrome plated zinc alloy keys, std. (6 tumbler lock).

SWITCH HOUSING: Glass filled polyester (UL 94V-0).

CONTACTS AND TERMINALS: Q contact material: Copper, silver plated. See page H-10 for additional contact materials.

MOUNTING NUT: Zinc alloy or steel, nickel or bright zinc plated.

MOUNTING CLIP: Steel, nickel or bright zinc plated.

DRESS NUT: Brass, nickel plated.

TERMINAL SEAL: Epoxy.

NOTE: Specifications and materials listed above are for switchlocks with standard options. For information on specific and custom switchlocks, consult Customer Service Center.

SWITCHLOCKS WITH STANDARD OPTIONS

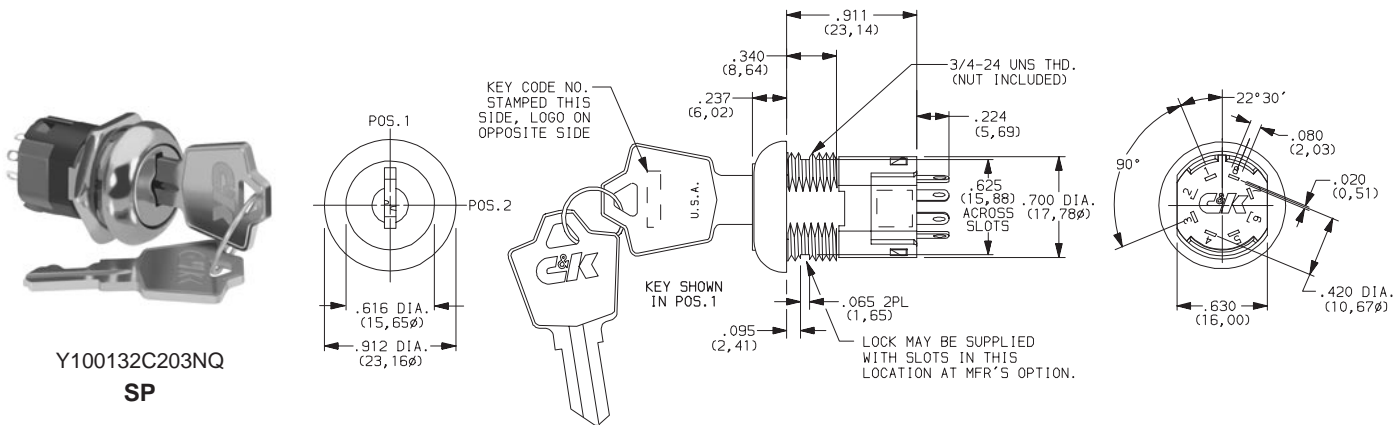

Y100132C203NQ
SP

PART NUMBER	NO. TUMBLERS	INDEXING
Y100132C203NQ	4	45°

NOTE: For panel mounting information, see page H-10.



Y1011U2V203NQ
SP

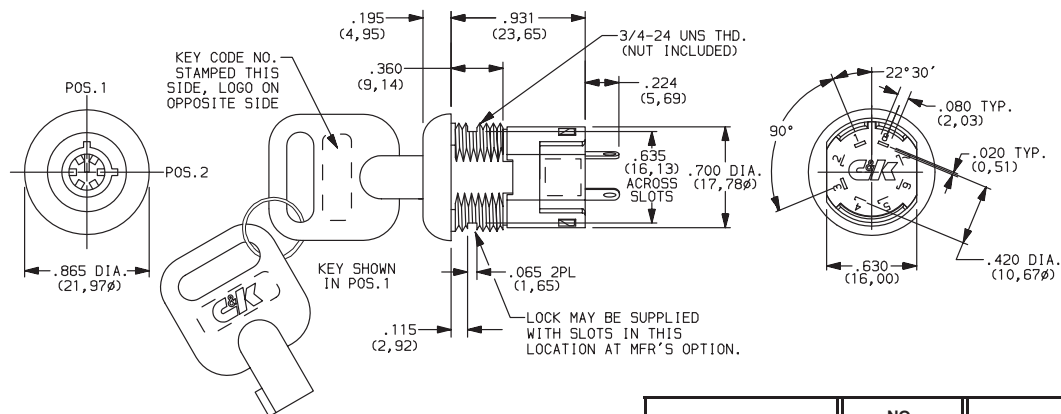

PART NUMBER	NO. TUMBLERS	INDEXING
Y1011U2V203NQ	6	90°

NOTE: For panel mounting information, see page H-10.

C&K Y Series 4 & 6 Tumbler Switchlocks

SWITCH AND LOCK FUNCTION



H

Switchlock

SINGLE & DOUBLE POLE SWITCHES									
NO. TUMBLERS	NO. POLES	MODEL NO.	CONNECTED TERMINALS				KEY PULL POSITIONS	LOCK CONFIGURATION	INDEXING
			POS. 1	POS. 2	POS. 3	POS. 4			
4 & 6	SP DP	Y10013 Y20013	8-1 8-1, 4-5	1-2 1-2, 5-6	2-3 2-3, 6-7		Position 1		45°
4	SP DP	Y1001C Y2001C	8-1 8-1, 4-5	1-2 1-2, 5-6	2-3 2-3, 6-7		Position 3		
4 & 6	SP DP	Y1001U Y2001U	8-1 8-1, 4-5	1-2 1-2, 5-6	2-3 2-3, 6-7		Positions 1 & 3		
4	SP DP	Y10082 Y20082	8-1 8-1, 4-5	1-2 1-2, 5-6	7-8 7-8, 3-4		Position 1		
4	SP DP	Y100AA Y200AA	8-1 8-1, 4-5	1-2 1-2, 5-6	7-8 7-8, 3-4		Positions 1, 2 & 3		
4	SP	Y100AB	8-1	1-2	2-3	3-4	Positions 1, 2, 3 & 4		
4 & 6	SP DP	Y10113 Y20113	8-1 8-1, 4-5	1-3 1-3, 5-7			Position 1		90°
4	SP DP	Y1011C Y2011C	8-1 8-1, 4-5	1-3 1-3, 5-7			Position 2		
4 & 6	SP DP	Y1011U Y2011U	8-1 8-1, 4-5	1-3 1-3, 5-7			Positions 1 & 2		
4	SP	Y14173	7-1	1-3	6-7		Position 1		
4	SP	Y1417C	7-1	1-3	6-7		Positions 2 & 3		
4	SP	Y1417U	7-1	1-3	6-7		Positions 1, 2 & 3		
SINGLE & DOUBLE POLE MOMENTARY SWITCHES									
NO. TUMBLERS	NO. POLES	MODEL NO.	CONNECTED TERMINALS				KEY PULL POSITIONS	LOCK CONFIGURATION	INDEXING
			POS. 1	POS. 2	POS. 3	POS. 4			
4	SP DP	Y10812 Y20812	8-1 8-1, 4-5	1-2 1-2, 5-6			Position 1		45° Mom.
4	SP DP	Y10882 Y20882	8-1 8-1, 4-5	1-2 1-2, 5-6	7-8 7-8, 3-4		Position 1		

LEGEND

- ▲ = Momentary Positions (45°)
- = Detent Positions (45° or 90°)
- ⊙ = Key pull possible in these positions.
- ↑ = Stop Positions

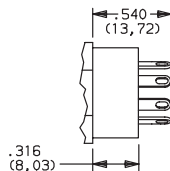

TERMINAL NUMBERS

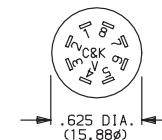

Terminal numbers molded on bottom of housing.

All models with all options when ordered with 'G' or 'Q' contact material.

NOTE: Other 3 position momentary models available, consult Customer Service Center.

C&K Y Series 4 & 6 Tumbler Switchlocks

SWITCH AND LOCK FUNCTION

SINGLE & DOUBLE POLE MOMENTARY SWITCHES

NO. TUMBLERS	NO. POLES	MODEL NO.	CONNECTED TERMINALS				KEY PULL POSITIONS	LOCK CONFIGURATION	INDEXING
			POS. 1	POS. 2	POS. 3	POS. 4			
4	SP DP	Y108AD Y208AD	8-1 8-1, 4-5	1-2 1-2, 5-6	7-8 7-8, 3-4		Positions 1&3		45° Mom.
4	SP DP	Y108AH Y208AH	8-1 8-1, 4-5	1-2 1-2, 5-6	7-8 7-8, 3-4		Position 1		
4	SP DP	Y108AJ Y208AJ	8-1 8-1, 4-5	1-2 1-2, 5-6	7-8 7-8, 3-4		Position 3		

LEGEND

- ▲ = Momentary Positions (45°)
- = Detent Positions (45° or 90°)
- ⊙ = Key pull possible in these positions.
- ⊙ = Stop Positions

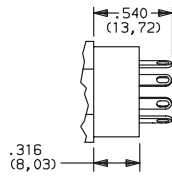

TERMINAL NUMBERS

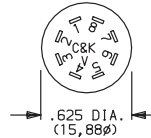

Terminal numbers molded on bottom of housing.

All models with all options when ordered with 'G' or 'Q' contact material.

NOTE: Other 3 position momentary models available, consult Customer Service Center.

SINGLE POLE SWITCHES WITH COMMON

NO. TUMBLERS	NO. POLES	MODEL NO.	CONNECTED TERMINALS				KEY PULL POSITIONS	LOCK CONFIGURATION	INDEXING
			POS. 1	POS. 2	POS. 3	POS. 4			
4	SP	Y19073					Position 1		90°
		Y1907C	C-1	C-2	C-4		Positions 2 & 3		
		Y1907U					Positions 1, 2 & 3		
		Y19001					Positions 1 & 3		
		Y1900A	C-1	C-2	C-3	C-4	Positions 2 & 4		
		Y1900S					Positions 1, 2, 3 & 4		

LEGEND

- = Detent Positions (45° or 90°)
- ⊙ = Key pull possible in these positions.
- ⊙ = Stop Positions

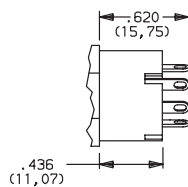

TERMINAL NUMBERS

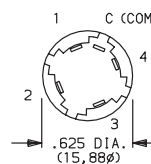

Terminal numbers marked on insulator.

All models with all options when ordered with 'G' or 'Q' contact material.

NOTE: Epoxy seal not available. Removable dress nut not available with Y1900A models.

C&K Y Series 4 & 6 Tumbler Switchlocks

SWITCH AND LOCK FUNCTION



AVAILABLE OPTION COMBINATIONS															
MODELS	LOCK TYPES						TERMINATIONS					MOUNTING/LOCK STYLES			
	A	C	N	R	V	W	01	02	03	07	WC	D	L	N	R
YX0013		•			•	•	•	•	•		•	•		•	•
YX001C		•					•	•	•		•			•	•
YX001U		•		•	•	•	•	•	•		•	•	•	•	•
YX0082		•		•			•	•	•		•			•	•
YX00AX		•		•			•	•	•		•			•	•
YX0113		•		•	•	•	•	•	•		•			•	•
YX011C		•		•			•	•	•		•			•	•
YX011U		•		•	•	•	•	•	•		•	•	•	•	•
Y141XX		•		•			•	•	•		•			•	•
YX0812	•		•				•	•	•		•	•		•	•
YX08AH	•		•				•	•	•		•	•		•	•
Y190XX		•		•				•		•	•			•	•
YX08AD	•		•				•	•	•		•	•		•	•
YX08AJ	•		•				•	•	•		•	•		•	•

KEYING

OPTION CODE	KEYING OPTIONS	CODE NO. ON KEY	CODE NO. ON LOCK
2	(STD.) 2 NICKEL PLATED BRASS KEYS (4 TUMBLER) or 2 DIE CAST CHROME PLATED ZINC ALLOY KEYS (6 TUMBLER)	YES	NO
J	1 NICKEL PLATED BRASS KEY WITH PLASTIC INSERT MOLDED ROUND HEAD AND 1 NICKEL PLATED BRASS KEY	YES	YES
T	1 NICKEL PLATED BRASS KEY WITH PLASTIC INSERT MOLDED SQUARE HEAD AND 1 NICKEL PLATED BRASS KEY	YES	NO

OPTION CODE	KEY COLOR
NONE	(STD.) NICKEL PLATED BRASS (4 TUMBLER) OR CHROME PLATED ZINC ALLOY (6 TUMBLER)
1	WHITE
2	BLACK
3	RED
T	BEIGE

NOTE: All orders keyed alike, standard. For more than one key code, master keying, replacement keys, or other special features, consult Customer Service Center.

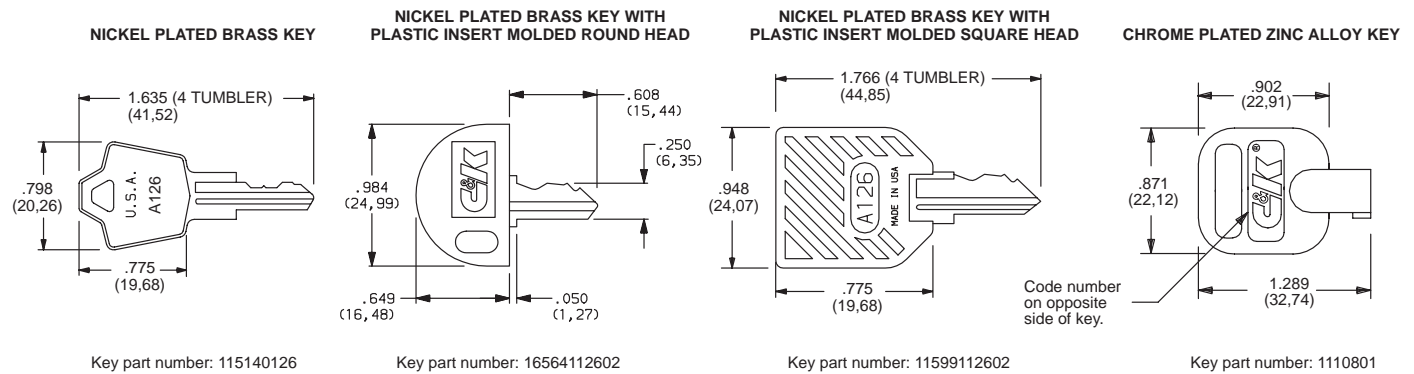

C&K Y Series 4 & 6 Tumbler Switchlocks



H

Switchlock

LOCK TYPE

C (STD.) 4 TUMBLER LOCK WITH DETENT

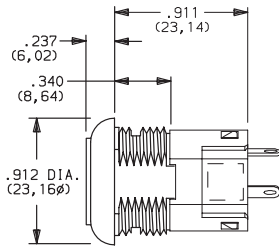

V (STD.) 6 TUMBLER TUBULAR LOCK

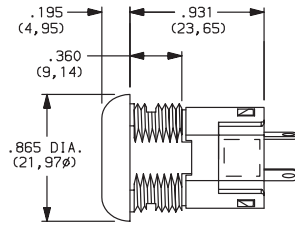

A 4 TUMBLER LOCK (MOMENTARY MODELS ONLY)

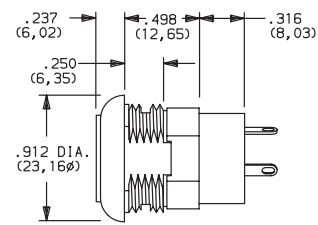

Available with Lock Finish '2' only.

SHORT ANTI-STATIC LOCK TYPES

N 4 TUMBLER LOCK WITH SHORT ANTI-STATIC SWITCH (MOMENTARY MODELS ONLY)

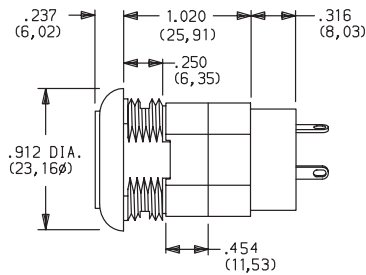

R 4 TUMBLER LOCK WITH DETENT AND SHORT ANTI-STATIC SWITCH.

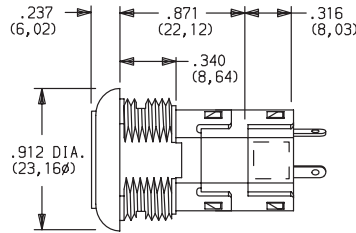

W 6 TUMBLER TUBULAR LOCK WITH ANTI-STATIC SWITCH

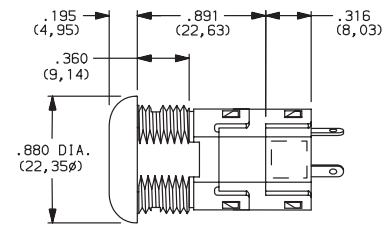

Available with Lock Finish '2' only.

NOTE: For available option combinations, see chart on page H-10.
U.S. Pat. No. 4,639,562 Exceeds 20 KV DC static resistance @ sea level, lock body to terminals.

LOCK FINISH

2 (STD.) STAINLESS STEEL

1 NICKEL

4 POLISHED NICKEL

8 GLOSS BLACK

F POLISHED NICKEL



Available with
Lock Types 'V' & 'W' only.

NOTE: For available option combinations, see page H-10.

TERMINATIONS

03 (STD.) SOLDER LUG WITH HOLE

01 SOLDER LUG WITH NOTCH

02 PC THRU-HOLE

WC WIRE LEAD

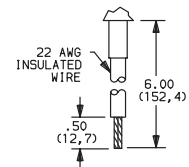
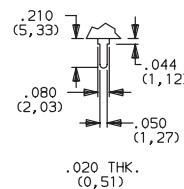
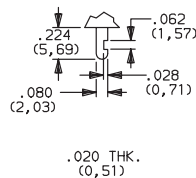
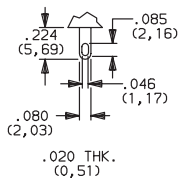

Black wire standard. other colors
and lengths available, consult
Customer Service Center.
UL style 1015.

All Models Except Y190



Cannon

C&K Y Series 4 & 6 Tumbler Switchlocks



Switchlock

TERMINATIONS

02 PC THRU-HOLE

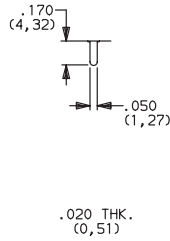

07 SOLDER LUG WITH HOLE

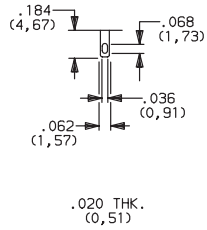

WC WIRE LEAD

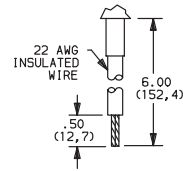

Black wire standard. other colors and lengths available, consult Customer Service Center. UL style 1015.

PC MOUNTING

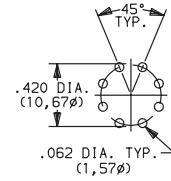

Y190 Model Only

MOUNTING/LOCK STYLE

N (STD.) WITH NUT

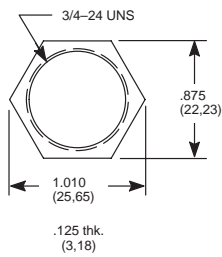

Nut part number: 175050700

D WITH CLIP

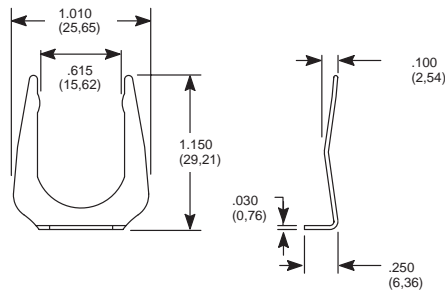

Clip part number: 175050300

OPTION CODE	MOUNTING STYLE	PANEL THICKNESS
N	(STD.) WITH NUT	.085-.105 (2,16-2,67)
D	WITH CLIP	.085-.105 (2,16-2,67)

R REMOVABLE DRESS NUT

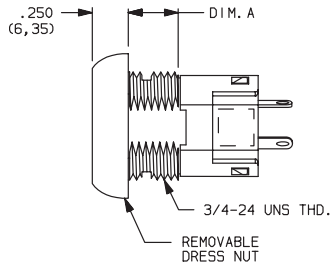
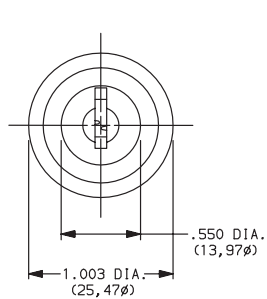

TYPICAL INSTALLATION

Install hex nut with enough clearance to allow for dress nut and panel. Place switch through cutout in rear of panel. Install and tighten dress nut by hand, then tighten hex nut. Always tighten assembly with back of panel hex nut to avoid damaging front of panel.

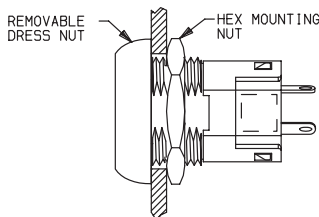

LOCK DIMENSIONS	
LOCK TYPES	DIMENSIONS
	'A'
A, N	.270 (6,68)
C & R	.360 (9,14)

NOTE: Removable dress nut not available with Y1900A model.

C&K Y Series 4 & 6 Tumbler Switchlocks

MOUNTING/LOCK STYLE

L REMOVABLE DRESS NUT WITH LATCH PAWL

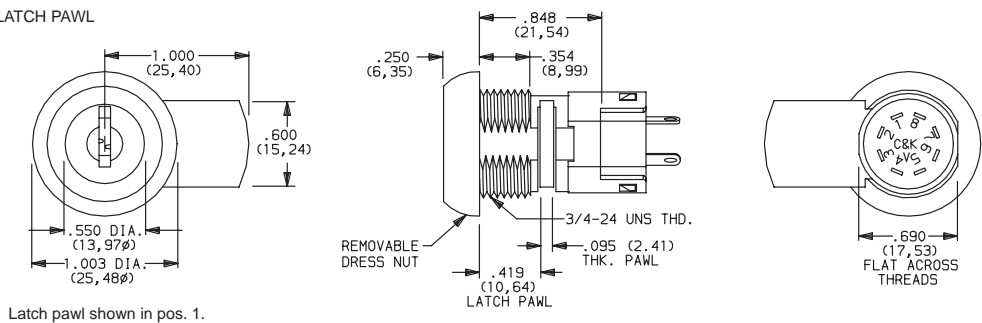

Latch pawl shown in pos. 1.

Mounting Information (All Models)

PANEL THICKNESS			
MOUNTING STYLES	A, N LOCK TYPES	C, R LOCK TYPES	V, W LOCK TYPES
D	.065-.085 (1, 65-2, 16)		.085-.105 (2, 16-2, 67)
N	.105 (2, 67) max.	.195 (4, 95) max.	.215 (5, 46) max.
L	.215 (5, 46) max.		
R	.125 (3, 18) max.	.215 (5, 46) max.	—

AVAILABLE OPTION COMBINATIONS											
MOUNTING STYLES	LOCK FINISHES					LOCK TYPES					
	1	2	4	8	F	A	C	N	R	V	W
D		•		•	•	•	•	•	•	•	•
N		•		•	•	•	•	•	•	•	•
R	•		•	•		•	•	•	•		
L	•		•	•		•	•	•			

PANEL MOUNTING

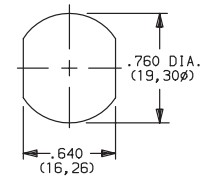

For models with 'N' or 'D' mounting styles.

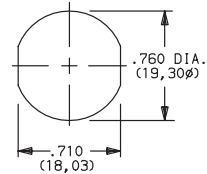

For models with 'R' or 'L' mounting style.

CONTACT MATERIAL



OPTION CODE	CONTACT AND TERMINAL MATERIAL	RATINGS	
Q (STD.)	SILVER ²	POWER	4 AMPS @ 125 V AC OR 28 V DC; 2 AMPS @ 250 V AC (UL/CSA).
B	GOLD ¹	LOW LEVEL/DRY CIRCUIT	0.4 VA MAX. @ 20 V AC OR DC MAX.
G	GOLD OVER SILVER ³	LOW LEVEL/DRY CIRCUIT OR POWER	0.4 VA MAX. @ 20 V AC OR DC MAX. OR 4 AMPS @ 125 V AC OR 28 V DC; 2 AMPS @ 250 V AC (UL/CSA).

CONTACT MATERIAL/APPLICATION RECOMMENDATIONS — SEE CHART, PAGE L-31.

¹ CONTACTS & TERMINALS: Copper, with gold plate over nickel plate.

² CONTACTS & TERMINALS: Copper, silver plated (std. with all termination options).

³ CONTACTS & TERMINALS: Copper, with gold plate over silver plate.

All models   with all options when ordered with 'G' or 'Q' contact material.

SEAL

NONE (STD.) NO SEAL

E EPOXY SEAL

