

Features

- Laser diode with Multi-quantum-well structure
- Un-cooled operation at -40 to +85 °C
- High temperature operation without active cooling
- Built-in InGaAs monitor photodiode
- Hermetically sealed active component
- Complies with Telcordia Technologies GR-468-CORE
- TOSA
- FC/ST/SC Receptacle package with 2-hole flange
- Fiber pigtailed with optional FC/ST/SC/MU/LC connector
- Design for 2.5G high speed optics networks
- RoHS Compliant available

Absolute Maximum Ratings (Tc=25 °C)

Parameter	Symbol	Rating	Unit
Fiber Output Power L/M/H/2	P _f	1(L)/1.5(M)/2.5(H)/3(2)	mW
LD Reverse Voltage	V _{RLD}	2	V
PD Reverse Voltage	V _{RPD}	10	V
PD Forward Current	I _{FPD}	2	mA
Operating Temperature	T _{opr}	-40 ~ 85	°C
Storage Temperature	T _{stg}	-40 ~ 85	°C
Soldering Temperature (<10sec)	T _{temp}	260	°C

(All optical data refer to a coupled 9/125 μ m SM fiber)

Optical and Electrical Characteristics (Tc=25 °C)

Parameter	Symbol	Min.	Typ.	Max.	Unit	Notes
Threshold Current	I _{th}	-	10	15	mA	CW
Fiber Output Power	P _f	0.2 0.5 1 2	- - 1.6 2.5	0.5 1 - -	mW	CW, I _{th} +20mA, kink free
Peak Wavelength		1290	1310	1330	nm	CW, P _f = P _f (Min)
Spectrum Width (RMS)	Receptacle TOSA Pigtail	-	2 - -	5 3 3	nm	CW, P _f = P _f (Min)
Forward Voltage	V _F	-	1.2	1.5	V	CW, P _f = P _f (Min)
Rise Time / Fall Time	T _r / T _f	-	-	150	ps	I _{bias} =I _{th} , 10%~90%
Tracking Error	P _f / P _f	-1.5	-	1.5	dB	APC, -40 ~ 85 °C
PD Monitor Current	I _m	100	-	-	μ A	CW, P _f = P _f (Min), V _{RPD} = 2V

PD Dark Current	I_{dark}	-	-	0.1	μA	$V_{RPD} = 5V$
PD Capacitance	C_t	-	6	15	pF	$V_{RPD} = 5V, f = 1MHz$

Note:

1. Pin assignment can be customized.
2. Specifications subject to change without notice.

LD Pin Assignment

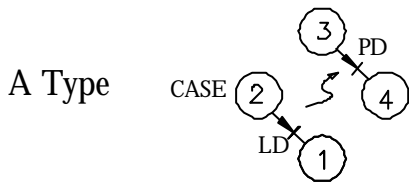

- Pin 1 : Laser Cathode
- Pin 2 : Laser Anode and Case Gnd
- Pin 3 : Monitor Diode Anode
- Pin 4 : Monitor Diode Cathode

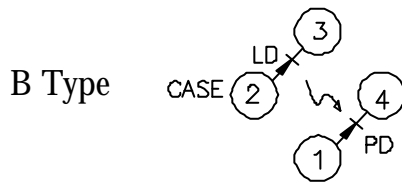

- Pin 1 : Monitor Diode Anode
- Pin 2 : Laser Anode and Case Gnd
- Pin 3 : Laser Cathode
- Pin 4 : Monitor Diode Cathode

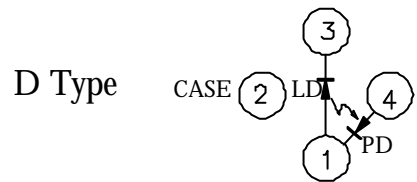

- Pin 1 : Laser Anode and Monitor Diode Cathode
- Pin 2 : Case Gnd
- Pin 3 : Laser Cathode
- Pin 4 : Monitor Diode Anode

Packaging Dimensions (Units in mm)

Part Number: C-13-002-RX-SXXXX-XX

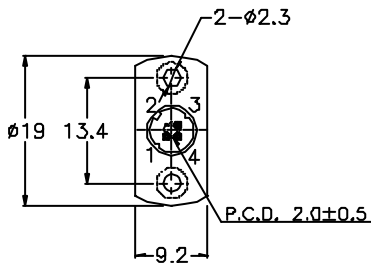

FC Receptacle

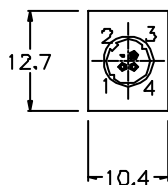
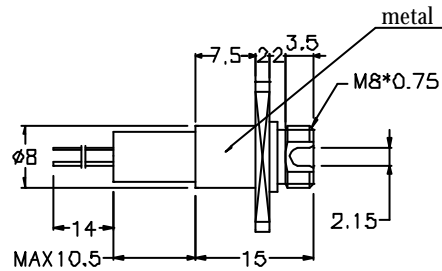

ST Receptacle

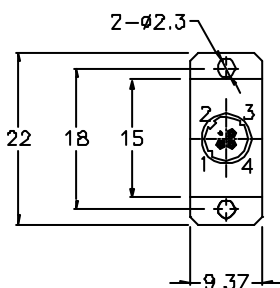
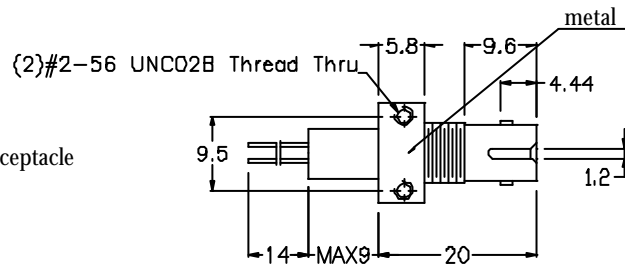

SC Receptacle

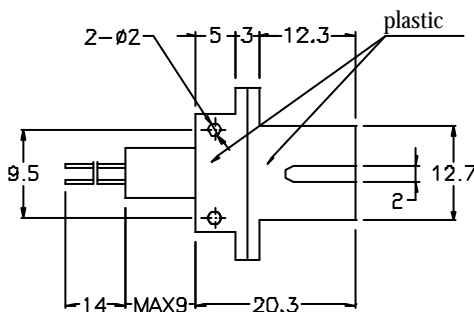

Packaging Dimensions (Units in mm)

Part Number: C-13-002-TX-SSCXX-XX

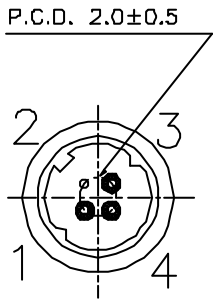

SC TOSA (L&M Power)
C-13-002-TX-SSCXX-XX

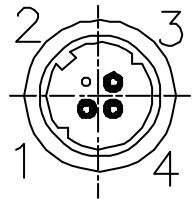
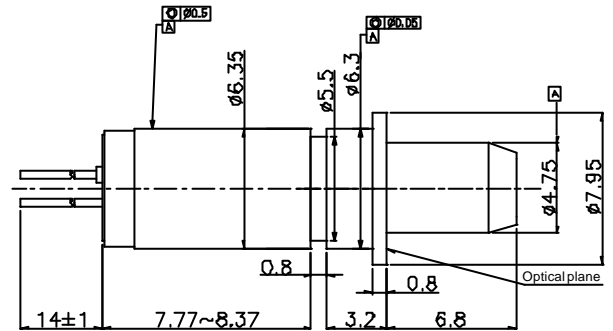

SC TOSA (L&M Power with Isolator)
C-13-002-TX-SSCXI-XX

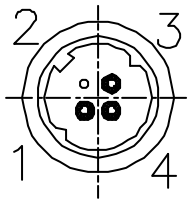
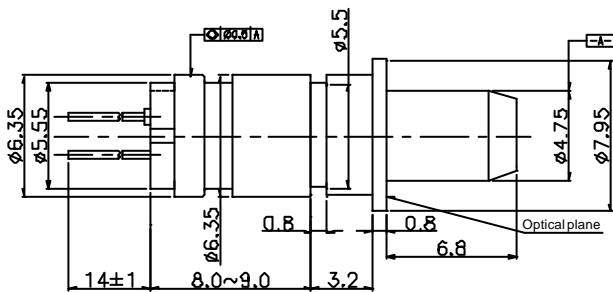

SC TOSA (H&2 Power)
C-13-002-TX-SSCXX-XX

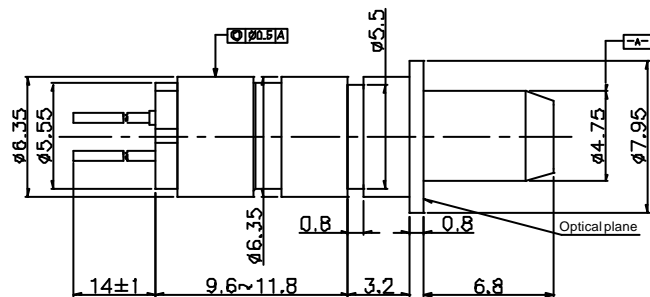

Packaging Dimensions (Units in mm)

Part Number: C-13-002-TX-SMUXX-XX

P.C.D. 2.0 ± 0.5

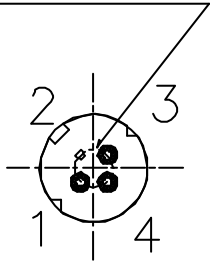

MU TOSA (L&M Power)
C-13-002-TX-SMUXX-XX

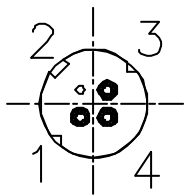
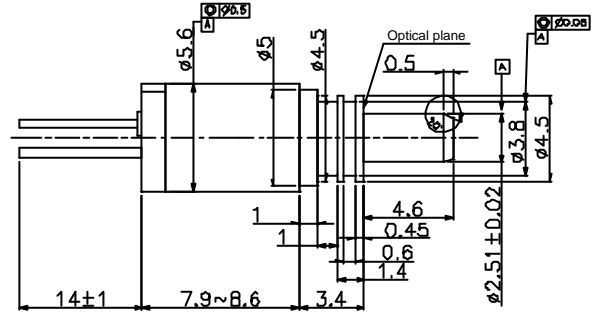

MU TOSA (L&M Power with Isolator)
C-13-002-TX-SMUXI-XX

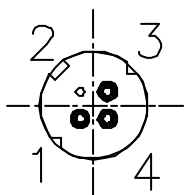
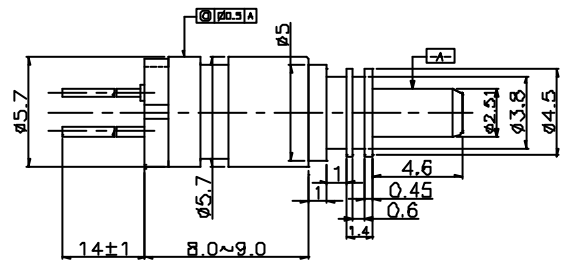

MU TOSA (H&2 Power)
C-13-002-TX-SMUXX-XX

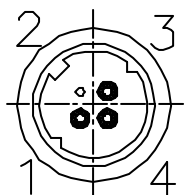
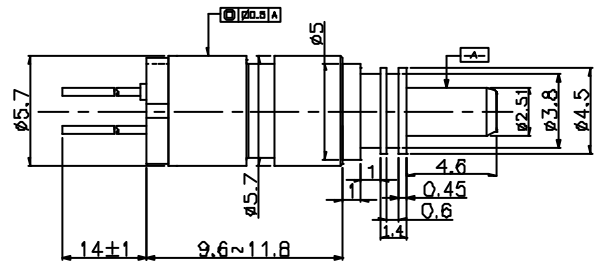

Customer Specified
TOSA

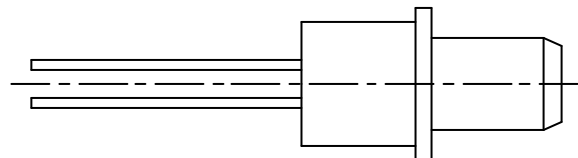

Packaging Dimensions (Units in mm)

Part Number: C-13-002-PX-SXXXX/XXX-X-XX

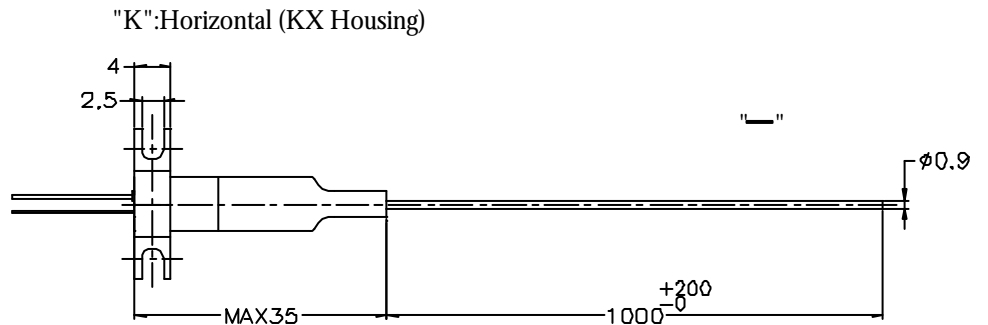
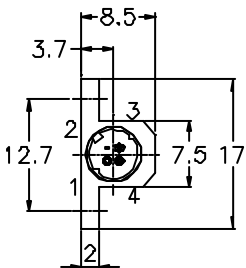
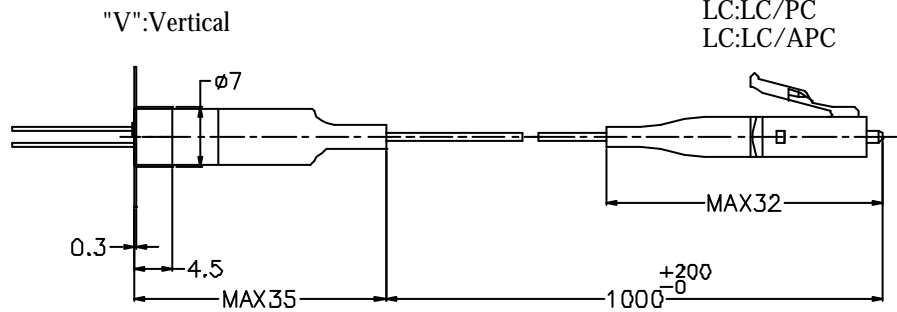
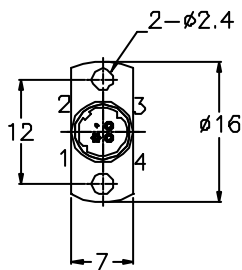
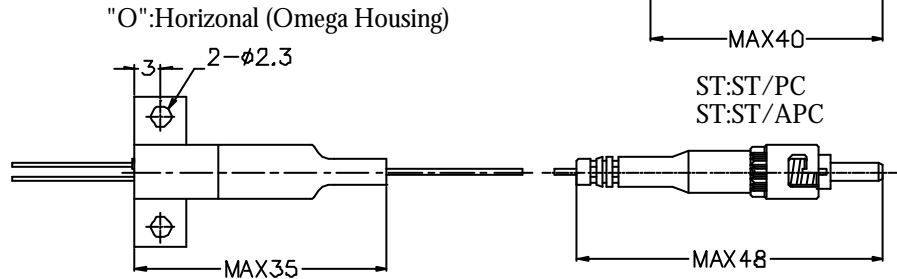
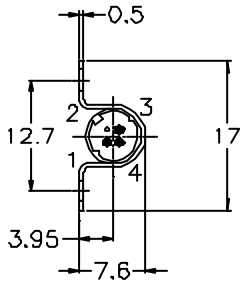
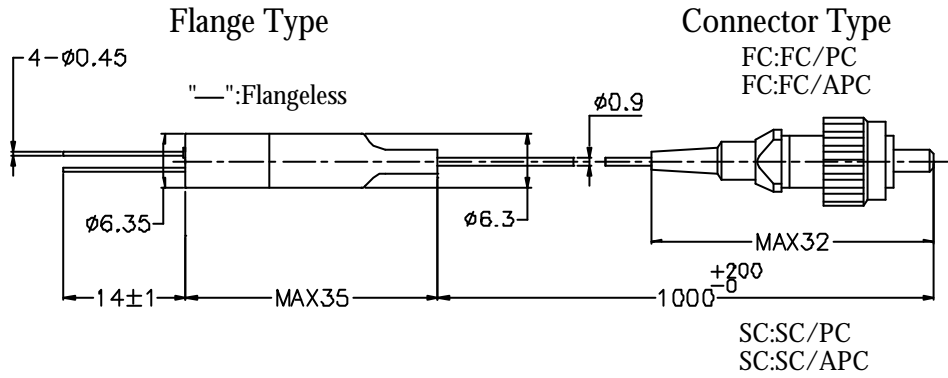
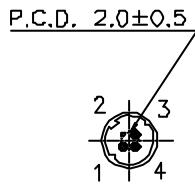

Ordering Information

C-13-002-XX-SXXXXX/XXX-X-XX

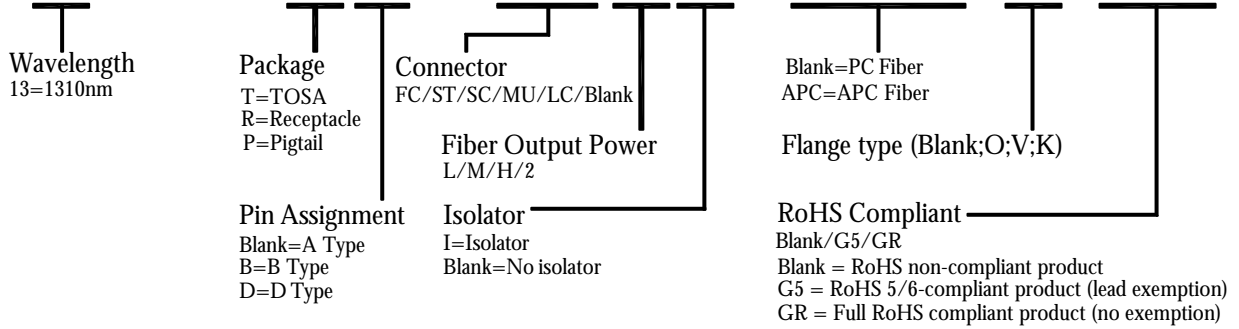

Warnings

Handling Precautions: This device is susceptible to damage as a result of electrostatic discharge (ESD). A static free environment is highly recommended. Follow guidelines according to proper ESD procedures.

Laser Safety: Radiation emitted by laser devices can be dangerous to human eyes. Avoid eye exposure to direct or indirect radiation.

Legal Notice

IMPORTANT NOTICE!

All information contained in this document is subject to change without notice, at Source Photonics' s sole and absolute discretion. Source Photonics warrants performance of its products to current specifications only in accordance with the company' s standard one-year warranty; however, specifications designated as "preliminary" are given to describe components only, and Source Photonics expressly disclaims any and all warranties for said products, including express, implied, and statutory warranties, warranties of merchantability, fitness for a particular purpose, and non-infringement of proprietary rights. Please refer to the company' s Terms and Conditions of Sale for further warranty information.

Source Photonics assumes no liability for applications assistance, customer product design, software performance, or infringement of patents, services, or intellectual property described herein. No license, either express or implied, is granted under any patent right, copyright, or intellectual property right, and Source Photonics makes no representations or warranties that the product(s) described herein are free from patent, copyright, or intellectual property rights. Products described in this document are NOT intended for use in implantation or other life support applications where malfunction may result in injury or death to persons. Source Photonics customers using or selling products for use in such applications do so at their own risk and agree to fully defend and indemnify Source Photonics for any damages resulting from such use or sale.

THE INFORMATION CONTAINED IN THIS DOCUMENT IS PROVIDED ON AN "AS IS" BASIS. Customer agrees that Source Photonics is not liable for any actual, consequential, exemplary, or other damages arising directly or indirectly from any use of the information contained in this document. Customer must contact Source Photonics to obtain the latest version of this publication to verify, before placing any order, that the information contained herein is current.

© Copyright Source Photonics, Inc. 2009

All rights reserved