

RECEPTACLES

BULKHEAD FEEDTHROUGH JACK RECEPTACLE (slide-on - rear fixing)

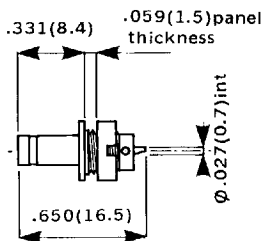
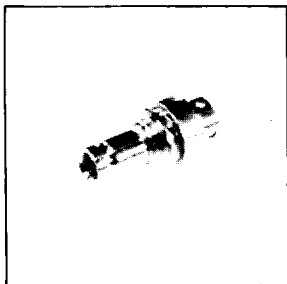

PART NO

R 120 550 215

RIGHT ANGLE RECEPTACLE FOR PRINTED CIRCUIT BOARD (screw-on or slide-on)

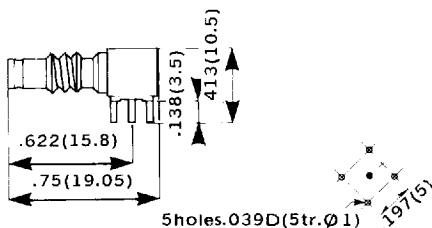
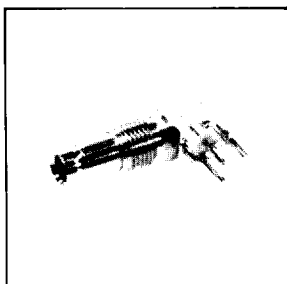

PART NO

R 118 680 215

IN SERIES ADAPTORS

2 NUTS FIXING JACK JACK (screw-on or slide-on)

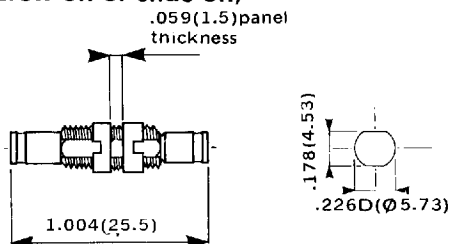
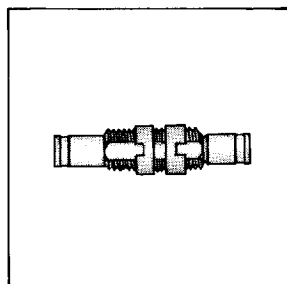

PART NO

R 118 704 215

BETWEEN SERIES ADAPTORS

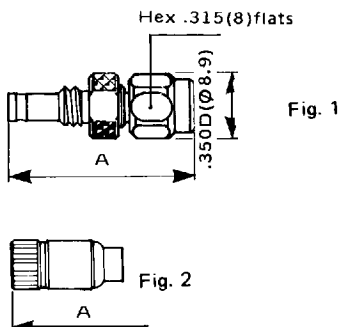
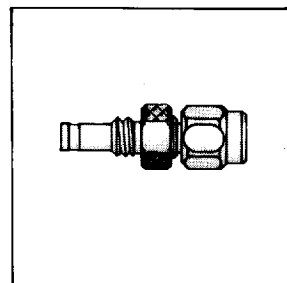

DESCRIPTION	RIM MALE 1.0 - 2.3 FEMALE (screw-on or slide-on)	RIM MALE 1.0 - 2.3 MALE (screw-on)
PART NO	R 191 369	R 191 368
Dim A	.968(24.6)	1.142(29)
Figure	1	2

DESCRIPTION	RIM MALE 1.0 - 2.3 FEMALE (screw-on or slide-on)	RIM MALE 1.0 - 2.3 MALE (screw-on)
PART NO	R 191 369	R 191 368
Dim A	.968(24.6)	1.142(29)
Figure	1	2