

Molded Chip Transformers

Type: **FJ09M, 11M, 13M, 15M, 11MH, 18MH, 20MH, 23MH FJ10, FJ10L**

Japan



For LCD panel backlight inverter

■ Features

- Miniature, thin size
- Extremely safe (due to molded enclosure)
- Suitable for automatic mounting

■ Recommended Applications

- Color View Finders
- Digital still cameras
- Notebook PCs
- Word processors
- LCD TV
- LCD displays

■ Explanation of Part Numbers

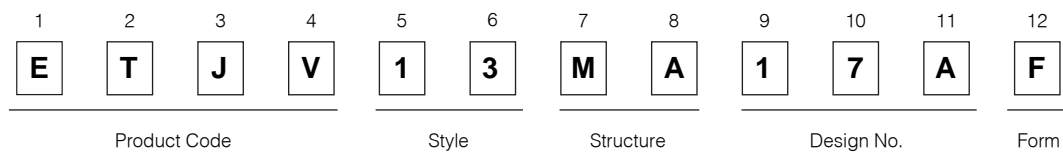

● FJ09M,11M,13M,15M,11MH (Embossed Carrier Taping)

FJ10, FJ10L (Embossed Carrier Taping)

Quantity	500 pcs/1 reel	1000 pcs/1 reel
Quantity/Shipping Box	1000 pcs/2 reels	2000 pcs/2 reels

● FJ18MH,20MH (Tray pack)

FJ23MH (Tray pack)

Quantity/Shipping Box	200 pcs	100 pcs
-----------------------	---------	---------

Example of Applications

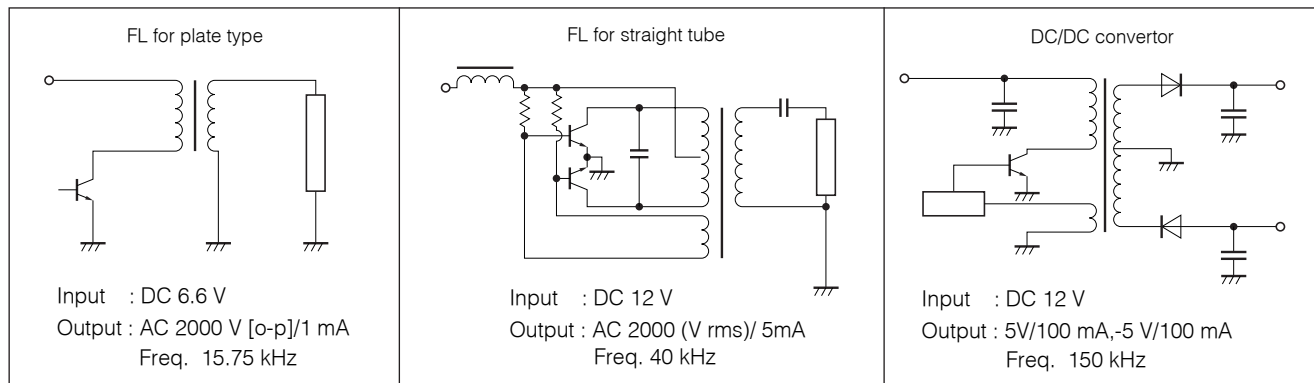

Example of Application Characteristics

Types	Input Volt. (V)	Max. Power (W)	Efficiency (%)	Open Volt.
FJ09M	3 to 6	1.0	75 to 85	2400 V[o-p]
FJ11M	3 to 12	2.0		1200 (V rms) max.
FJ13M	3 to 24	3.0	75 to 80	1400 (V rms) max.
FJ15M		4.0		1600 (V rms) max.
FJ11MH	3 to 12	3.0	75 to 85	1200 (V rms) max.
FJ18MH	3 to 24	6.0		1800 (V rms) max.
FJ18MHV		4.0		2200 (V rms) max.
FJ20MH		10.0		2000 (V rms) max.
FJ23MH		18.0		2000 (V rms) max.
FJ23MHV		13.0		2500 (V rms) max.
FJ10		3 to 6		1.5
FJ10L				

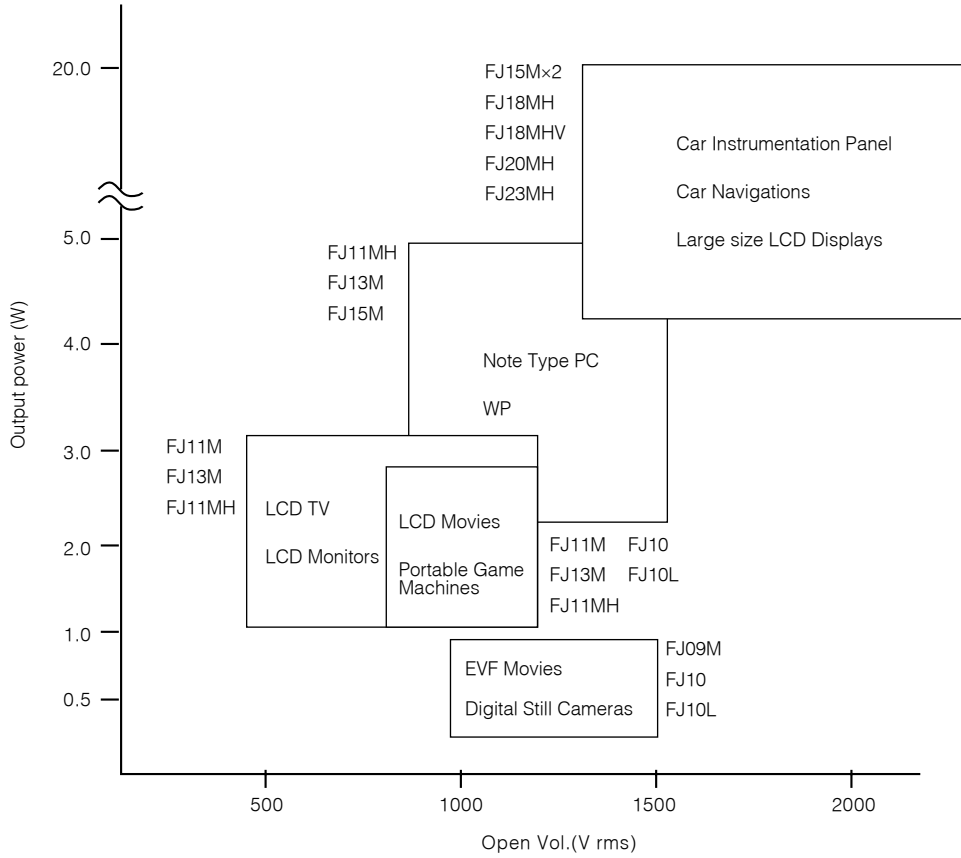

■ Dimensions in mm (not to scale)

FJ09M

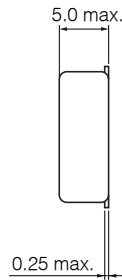
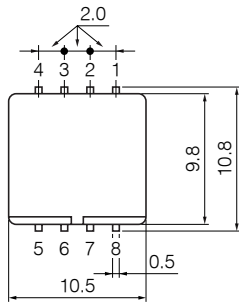

Recommended land pattern (Top View)

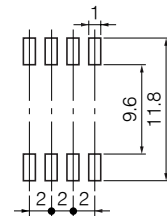

FJ11M

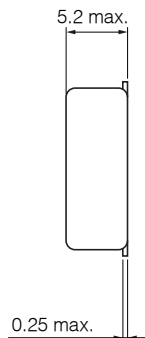
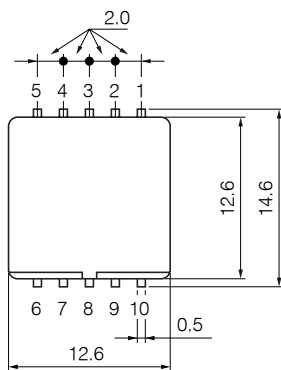

Recommended land pattern (Top View)

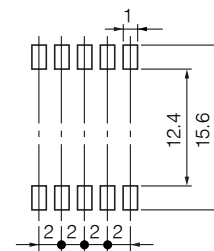

■ Dimensions in mm (not to scale)

FJ13M

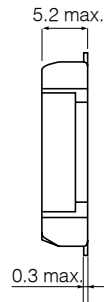
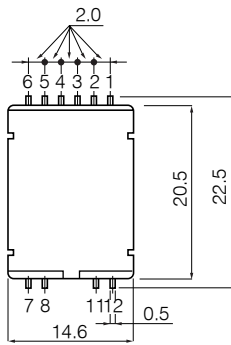

Recommended land pattern
(Top View)

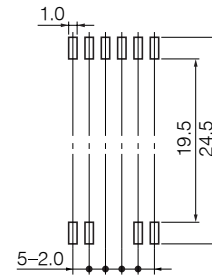

FJ15M

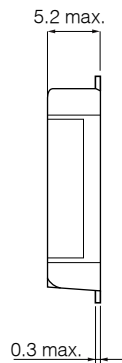
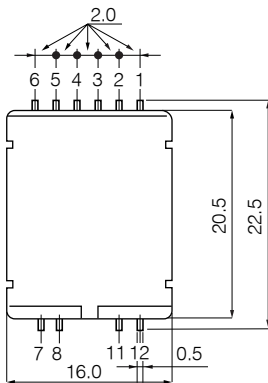

Recommended land pattern
(Top View)

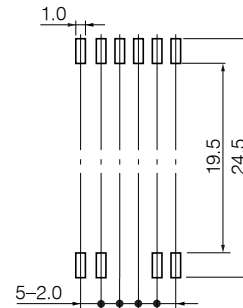

FJ11MH

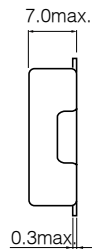
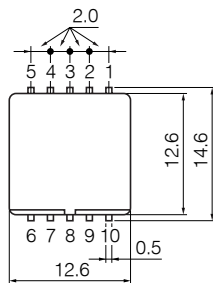

Recommended land pattern
(Top View)

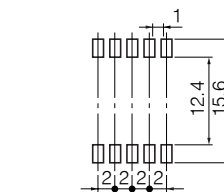

FJ18MH FJ18MHV

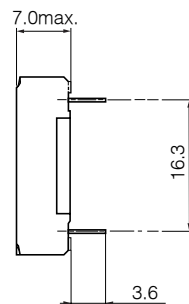
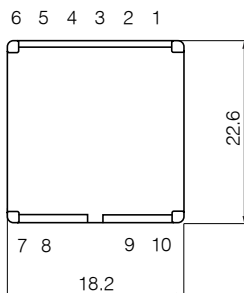

Recommended Piercing Plan
(Top View)

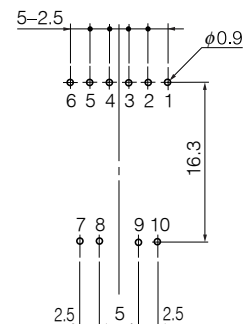

■ Dimensions in mm (not to scale)

FJ20MH

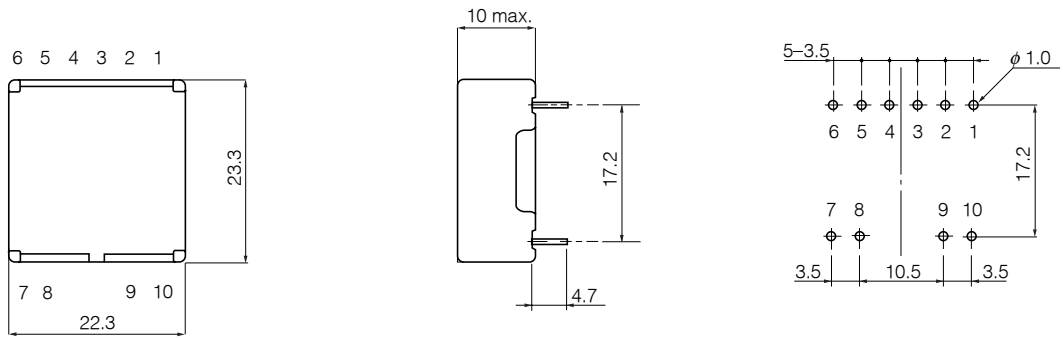

FJ23MH FJ23MHV

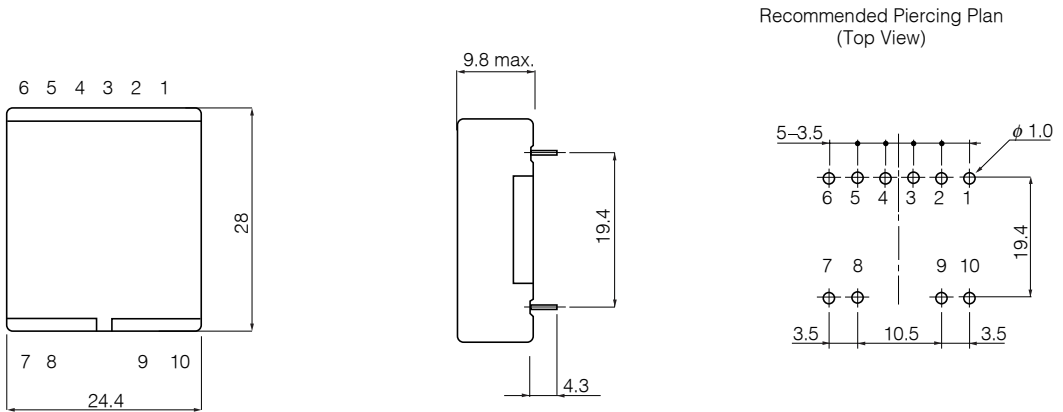

SMD type is available in FJ18MH, FJ20MH, and FJ23MH, too.

FJ10, FL10L

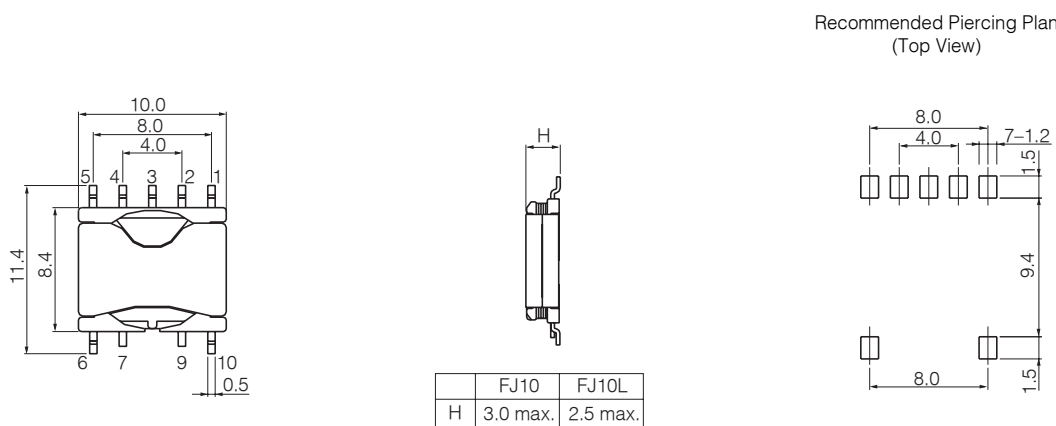

Safety Precautions

This product generates high voltage. Improper handling could result in electric shock, smoke or fire.

For reliability and safety, consider the following cautionary items.

- 1 Before using in final product, please confirm reliability and function under actual operating conditions of your specific application. If product malfunction occurs, due to improper installation or usage, smoking or burning of the device may result (the product may emit unusual sounds upon malfunction). The user is advised to include a protective failure circuit when designing.
2. There is a danger of electric shock if the product is touched during operation.
- 3 Performance characteristics may deteriorate if the product is subjected to excessive vibration or shock.
4. Some ultrasonic cleaning processes or cleaning agents (containing CFC) may damage the transformer. Please consult us regarding your specific cleaning process.
5. Do not store under high temperature, high moisture, corrosive gas atmospheres, or in areas affected by electromagnetic fields.
6. At storage exceeding 1 year, use the products only after inspecting the outer structure, because oxidation or a decline in solderability may have occurred.