

ANALOG CLOCK IC

■ GENERAL DESCRIPTION

The NJU6306 is an analog clock IC driving a stepping motor.

It consists of a quartz crystal oscillator, frequency divider, output pulse generators, push-pull motor drivers and alarm output.

The input and output of the quartz crystal oscillator are provided with oscillation capacitors. Consequently, only a quartz crystal is required as the external component.

The motor driving pulse width made by output pulse generators, alarm modulation pattern and alarm active level are all option.

■ PACKAGE OUTLINE

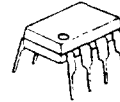

NJU6306XD

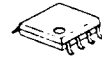

NJU6306XM

■ PIN CONFIGURATION/PAD LOCATION

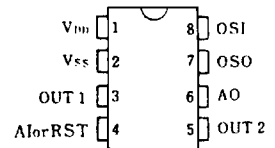
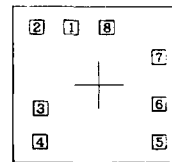

■ FEATURES

- Low Operating Current -- 1uA typ.
- Oscillation Capacitor On-chip
- Operating Voltage -- 1.5V
- Package Outline -- DIP/DMP 8
- C-MOS Technology

■ LINE-UP

Ver.	Motor Driving		Alarm Output			AI / RST	Int.Capa.	
	Pulse W.	Act.	Funda.	Mod.	Act.		C _i	C _o
A	46.875ms	L	2kHz	8Hz+1Hz	H	RST		
B	31.25ms	L	2kHz	8Hz+1Hz	H	AI		
C	23.438ms	L	2kHz	8Hz+1Hz	H	AI		
D	15.625ms	L	2kHz	8Hz+1Hz	H	AI		
F	15.625ms	H	2kHz	16Hz+1Hz	H	AI		
Y	31.25ms	L	2kHz	8Hz+1Hz	H	AI		
T	31.25ms	L	2kHz	8Hz+1Hz	L	RST		

■ COORDINATES

Unit: μm

No.	PAD	X	Y
1	V _{DD}	-183	401
2	V _{SS}	-421	401
3	OUT1	-394	-167
4	AI	-400	-401
5	OUT2	421	-401
6	AO	421	-135
7	OSO	421	193
8	OS1	63	401

Chip Size : 1.20 X 1.11mm
Chip Thickness: 400 μm ± 30 μm

■ BLOCK DIAGRAM

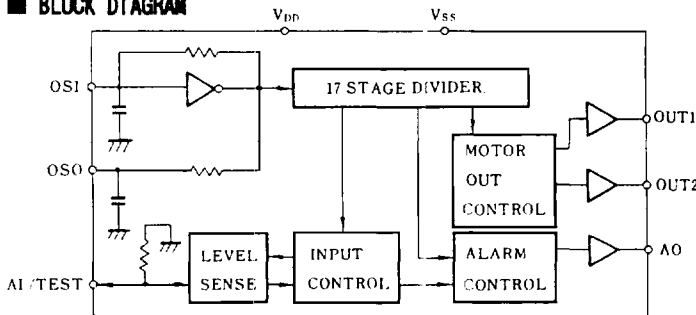

AI/RST terminal can change to RESET.

■ MASK OPTION

Except the Line-up table version also available selecting from the following option.

- Motor driving pulse width
- Motor output active level
- Alarm modulation wave
- Alarm output active level
- AI/RST Function (Pin No.4)
- Oscillation capacitor

■ TERMINAL DESCRIPTION

NO.	SYMBOL	F U N C T I O N
1	V _{DD}	+1.5V
2	V _{SS}	GND
3	OUT1	Stepping Motor Driving Terminal. Normally Active "L", Active "H" also available.
4	AI/RST	Alarm/Reset Input Terminal. (Either one is selected by mask option.) a) AI Function Normally Active "L", Active "H" also available. The alarm signal is output from AO terminal when this terminal is V _{DD} . b) RST Function Normally Active "L", Active "H" also available. When AI terminal is V _{SS} level, Motor driving output is stopped, and internal counter is reset. c) User-Test Function When 1/2V _{DD} level input to this terminal, the AO terminal output continuous 2kHz frequency for oscillation frequency adjustment.
5	OUT2	Stepping Motor Driving Terminal. Normally Active "L", Active "H" also available.
6	AO	Alarm Output Terminal. Normally Active "L", Active "H" also available. When user testing, The constant wave of 2kHz is output from this terminal.
7	OSO	Quartz Crystal Connecting Terminal. On-chip capacitance=30pF Max. (Refer the Line-up table for actual capacitance value)
8	OSI	Quartz Crystal Connecting Terminal. On-chip capacitance=15pF Max. (Refer the Line-up table for actual capacitance value)

■ FUNCTIONAL DESCRIPTION

(1) Motor Driving Output
(A.B.C.D.Y.T Versions)

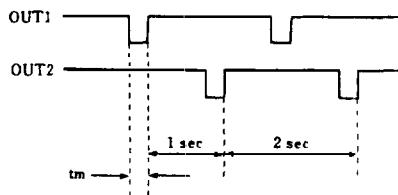

(F Version)

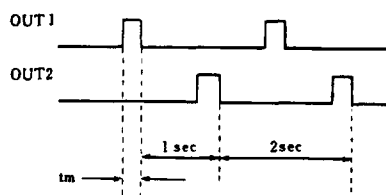

(2) Alarm Output Waveform

Alarm signal of the following pattern is output from the Alarm Output Terminal.
(Pin No.6)

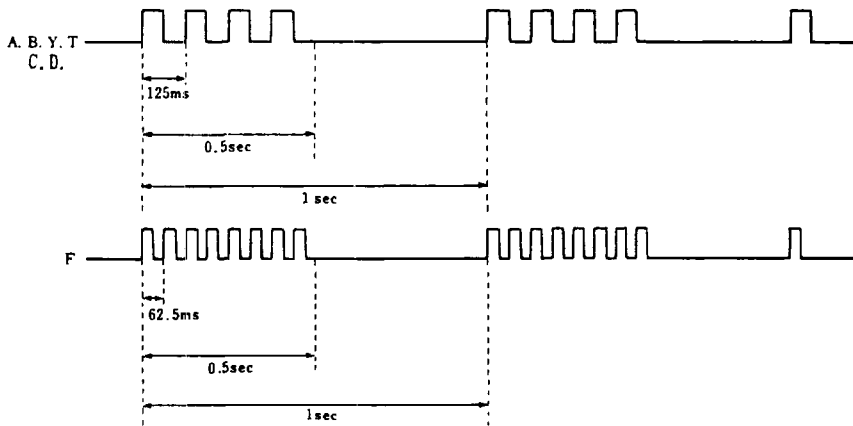

(3) Alarm Input/User Test

When $1/2V_{DD}$ level is input on pin No.4, AO output the continuous waveform for frequency adjustment shown below.

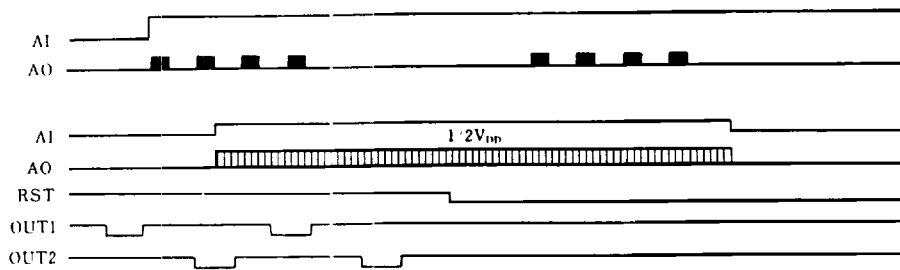
■ ABSOLUTE MAXIMUM RATINGS

($T_a=25^\circ\text{C}$)

PARAMETER	SYMBOL	RATINGS	UNIT
Supply Voltage	V_{DD}	- 0.3 ~ 7.0	V
Input Voltage	V_{IN}	- 0.3 ~ $V_{DD}+0.3$	V
Power Dissipation	P_D	(DIP) 250 (DMP) 200	mW
Operating Temperature	T_{opr}	- 20 ~ + 70	$^\circ\text{C}$
Storage Temperature	T_{stg}	- 40 ~ + 150	$^\circ\text{C}$
Soldering Temperature	T_{SLD}	260	$^\circ\text{C}$
Soldering Time	t_{SLD}	10	sec

■ ELECTRICAL CHARACTERISTICS

($V_{DD}-V_{SS}=1.5\text{V}$, $f_0=32.768\text{kHz}$, $T_a=25^\circ\text{C}$)

PARAMETER	SYMBOL	CONDITIONS	MIN	TYP	MAX	UNIT
Operating Voltage	V_{DD}		1.1		2.0	V
Operating Current	I_{DD}	No Load		1.0	2.0	μA
Motor Driving Current	I_M	$V_{ED}=1.2\text{V}$, $R_L=200\Omega$	4.0			mA
Alarm Output Current	I_{OH}	$V_{ED}=1.2\text{V}$, $V_{OH}=0.7\text{V}$	0.3			mA
	I_{OL}	$V_{ED}=1.2\text{V}$, $V_{OL}=0.5\text{V}$	0.3			
Input Voltage	V_{IH}	No.4 Terminal (AI or RST)	$V_{DD}-0.3$		V_{DD}	V
	V_{IL}		V_{SS}	$V_{SS}+0.3$		
	V_{TEST}		$0.9*1/2V_{DD}$	$1/2V_{DD}$	$1.1*1/2V_{DD}$	
Input Resistance	R_{IN}		10	30	90	$\text{k}\Omega$
Oscillation Stability	$\Delta f/f$				1.0	ppm/0.1V
Oscillation Capacitor	C_0	$f=100\text{kHz}$	-7%	Note	+7%	pF
	C_1					

Note) Typical value of on-chip capacitor is mentioned in Line-up table.