

TOSHIBA SOLID STATE IGBT GATE DRIVER MODULE

TF1206

TOSHIBA TF1206 is the IGBT gate driver designed for use with TOSHIBA Insulated Gate Bipolar Transistor Module and it includes the optical isolator and IGBT gate driver circuit. Using this driver, you can design high reliability and compact system.

- Recommended Conditions :
 Input Current : $I_F = 7.5\text{mA}$
 Output Supply Voltage : $V_{CC} = 15\text{V}$, $V_{EE} = -15\text{V}$
- High Speed Switching Response :
 $t_{pLH} = 0.5\mu\text{s}$ (Typ.)
 $t_{pHL} = 0.4\mu\text{s}$ (Typ.)
- Small Size and Light Weight
- 2500 V_{AC} Optical Isolation

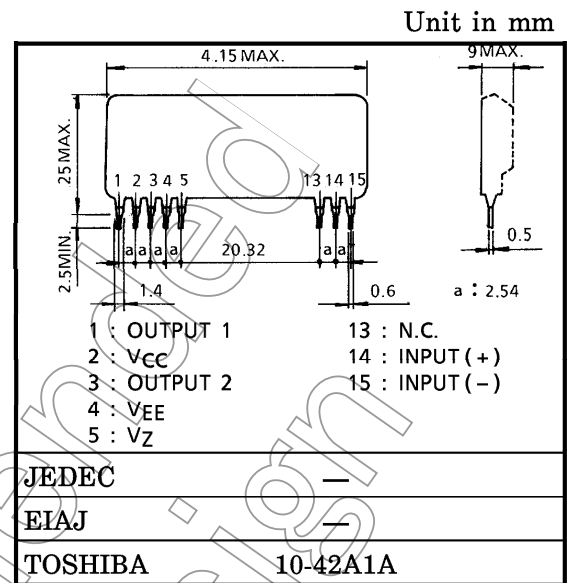

MAXIMUM RATINGS (Ta = 25°C)

CHARACTERISTIC	SYMBOL	RATING	UNIT
Input Current	I_F	20	mA
Reverse Input Voltage	V_R	5	V
Output Supply Voltage	V_{CC}	18	V
	V_{EE}	-18	
Output Voltage	V_{OUT}	$V_{CC} \sim V_{EE}$	V
High Level Peak Output Current (Note 1)	I_{OHP}	2 (10 μs)	A
Low Level Peak Output Current (Note 1)	I_{OLP}	-3 (10 μs)	A
Operating Frequency (Note 2)	f	30	kHz
Isolation (Input-Output)	$BV_{S/AC}$	2500 (1min)	V
Operating Temperature	T_{opr}	-20~70	°C
Storage Temperature	T_{stg}	-20~85	°C
Lead Soldering Temperature	T_{sol}	260°C (10s)	°C

Note 1 : Exponential Waveform (f=15kHz, Fig.1)

Note 2 : $I_{OHP} = 2\text{A}$ (5 μs), $I_{OLP} = -3\text{A}$ (5 μs), Exponential Waveform (Fig.1)

BLOCK DIAGRAM

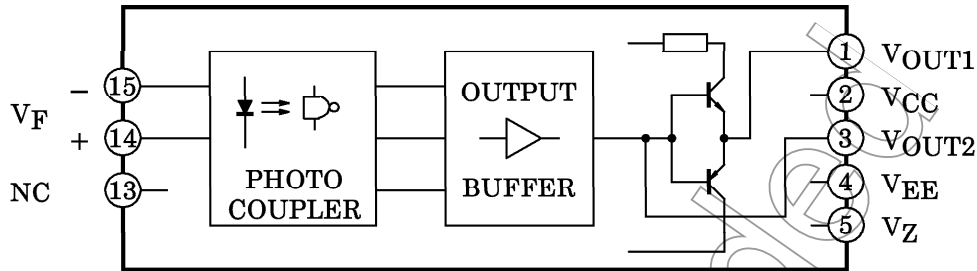

ELECTRICAL CHARACTERISTICS (Ta = 25°C, Vc = 5V, VCC = 5V, VEE = -15V, RZ = 500Ω, f = 10kHz)

CHARACTERISTIC	SYMBOL	TEST CONDITION	MIN.	TYP.	MAX.	UNIT
High Level Input Voltage	V _{FT}	V _{OUT1} > 0V (Fig.2, 3)	—	1.5	1.6	V
High Level Input Current	I _{FT}	V _{OUT1} > 0V (Fig.2, 3)	—	1.5	7.5	mA
Reverse Current	I _R	V _R = 5V	—	—	10	μA
High Level Output Voltage	V _{OH}	I _F = 7.5mA, R _L = 200Ω (Fig.2, 3)	13	13.5	—	V
Low Level Output Voltage	V _{OL}	I _F = 0mA, R _L = 200Ω (Fig.2, 3)	—	-13.5	-13	
High Level Supply Current	I _{CCH}	I _F = 7.5mA, V _{OUT1} > 0V (Fig.2, 3)	—	25	—	mA
Low Level Supply Current	I _{CCL}	I _F = 0mA, V _{OUT1} < 0V (Fig.2, 3)	—	20	—	
Zener Voltage (Coupler Supply)	V _Z	I _Z = 20mA, 4pin to 5pin	—	5.1	—	V
Propagation Delay Time to High Output Level	t _{pLH}	I _F = 7.5mA, V _{OUT1} > 0V R _L = 200Ω	—	0.5	1.0	μs
Output Rise Time	t _r	(Fig.2, 3)	—	0.25	—	
Propagation Delay Time to Low Output Level	t _{pHL}	I _F = 0mA, V _{OUT1} < 0V R _L = 200Ω	—	0.4	0.8	μs
Output Fall Time	t _f	(Fig.2, 3)	—	0.10	—	
Common Mode Transient Immunity at Logic High Output	CM _H	V _{CM} = 400V	1	10	—	kV / μs
Isolation Resistance (Input-Output)	R _S	V = 1kV, RH = 40~60%	—	10 ¹⁰	—	Ω

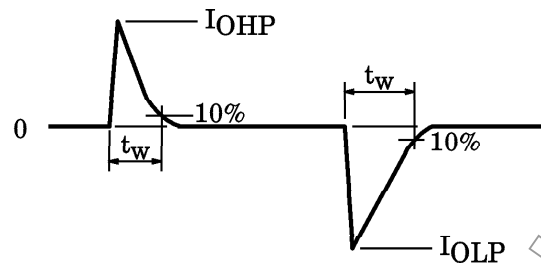

Fig.1 EXPONENTIAL WAVEFORM

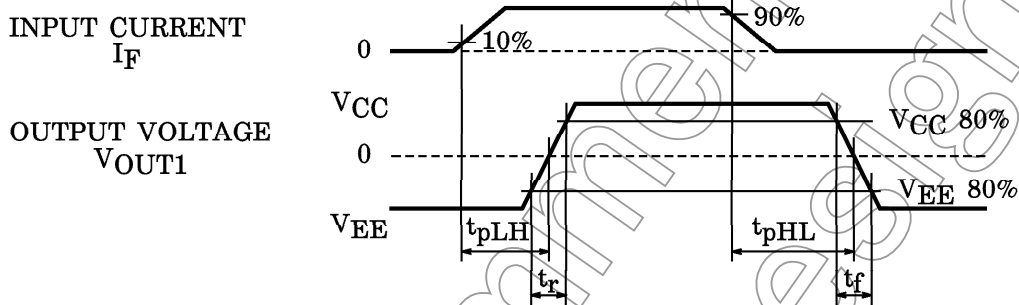

Fig.2 SWITCHING TIME TEST CONDITION

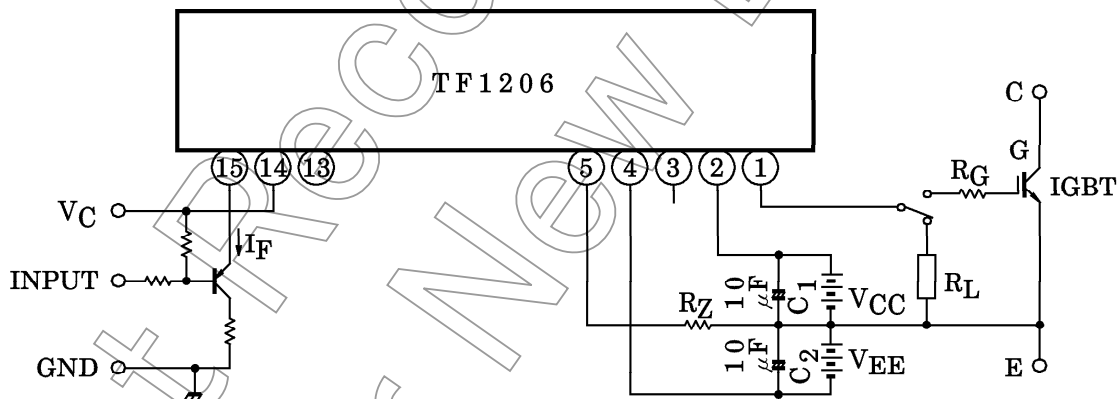
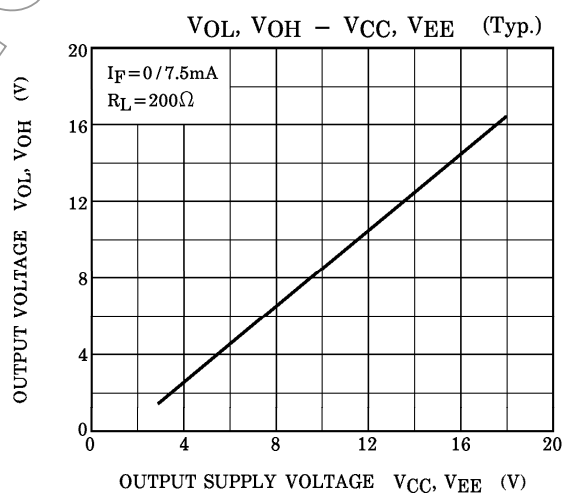
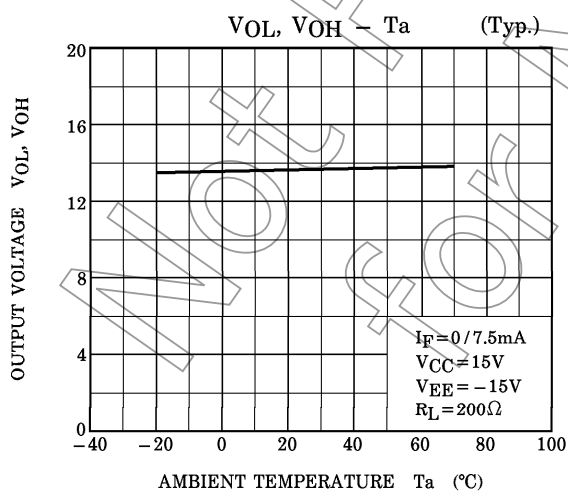
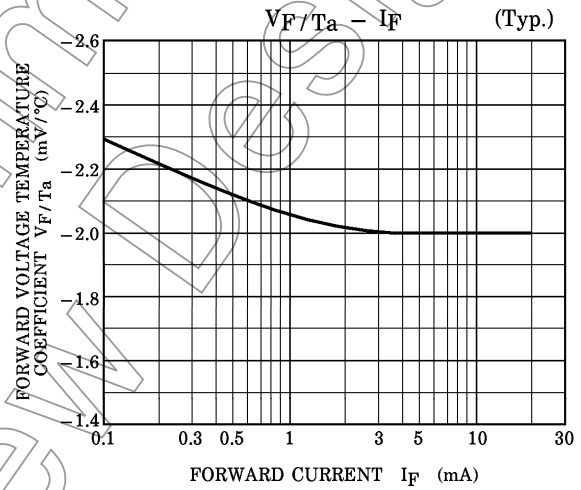
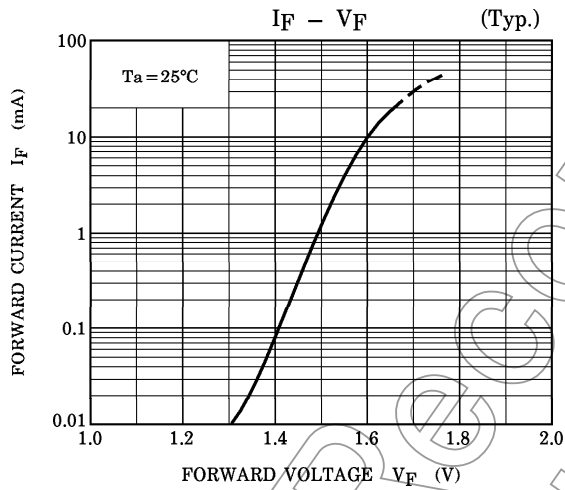
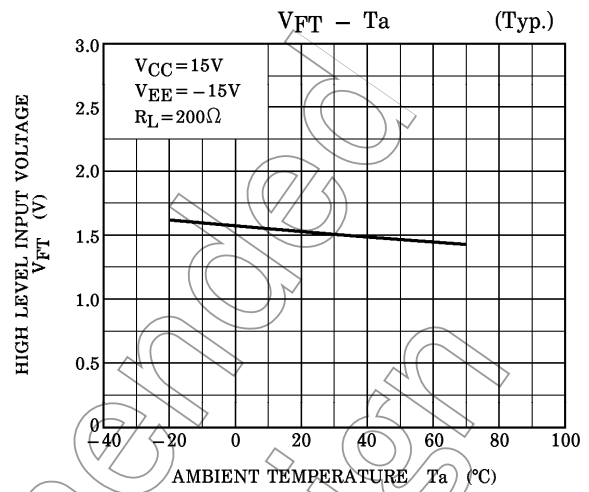
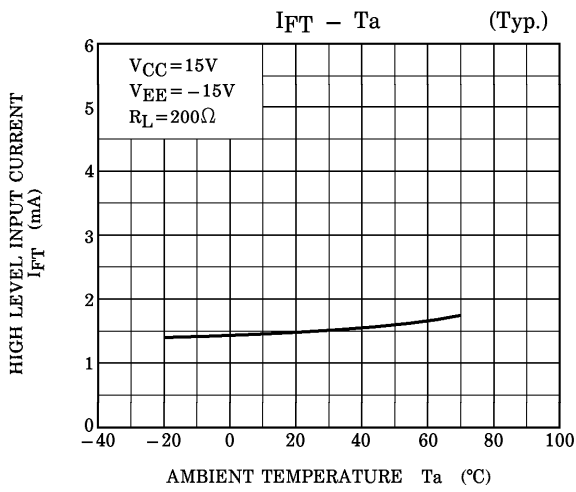
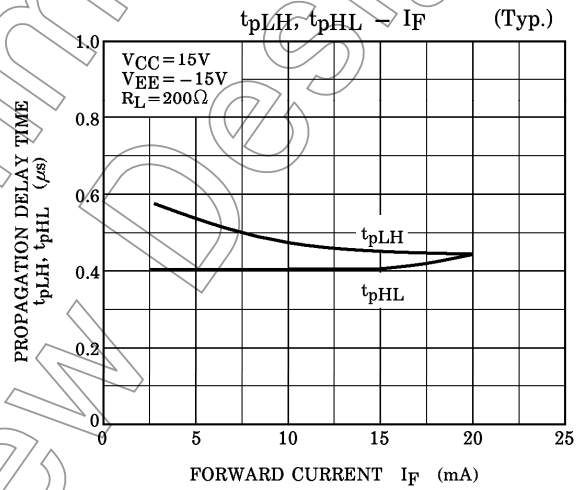
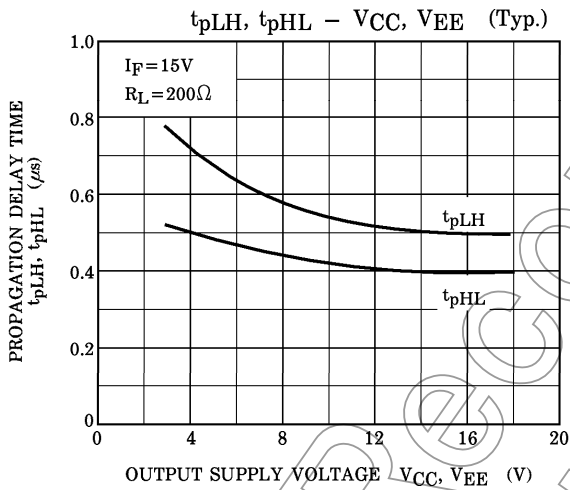
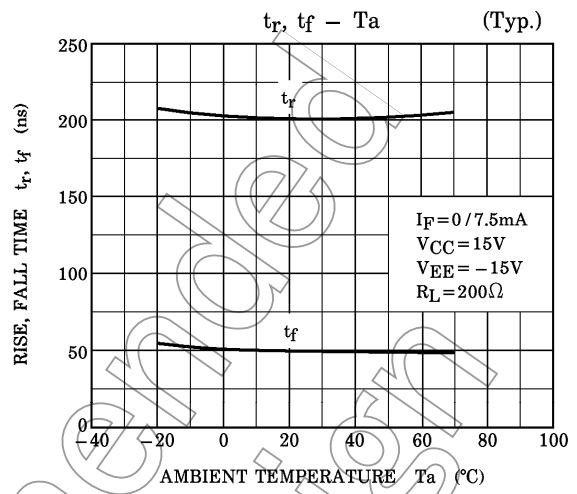
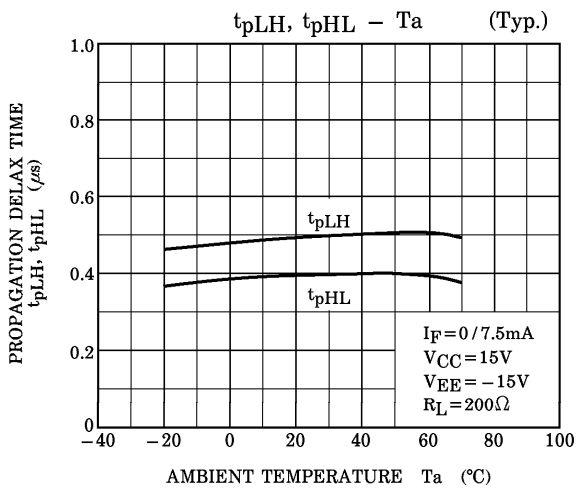

Fig.3 SWITCHING TIME TEST CIRCUIT





Not Recommended for New

RESTRICTIONS ON PRODUCT USE

000707EBA

- TOSHIBA is continually working to improve the quality and reliability of its products. Nevertheless, semiconductor devices in general can malfunction or fail due to their inherent electrical sensitivity and vulnerability to physical stress. It is the responsibility of the buyer, when utilizing TOSHIBA products, to comply with the standards of safety in making a safe design for the entire system, and to avoid situations in which a malfunction or failure of such TOSHIBA products could cause loss of human life, bodily injury or damage to property. In developing your designs, please ensure that TOSHIBA products are used within specified operating ranges as set forth in the most recent TOSHIBA products specifications. Also, please keep in mind the precautions and conditions set forth in the "Handling Guide for Semiconductor Devices," or "TOSHIBA Semiconductor Reliability Handbook" etc..
- The TOSHIBA products listed in this document are intended for usage in general electronics applications (computer, personal equipment, office equipment, measuring equipment, industrial robotics, domestic appliances, etc.). These TOSHIBA products are neither intended nor warranted for usage in equipment that requires extraordinarily high quality and/or reliability or a malfunction or failure of which may cause loss of human life or bodily injury ("Unintended Usage"). Unintended Usage include atomic energy control instruments, airplane or spaceship instruments, transportation instruments, traffic signal instruments, combustion control instruments, medical instruments, all types of safety devices, etc.. Unintended Usage of TOSHIBA products listed in this document shall be made at the customer's own risk.
- The products described in this document are subject to the foreign exchange and foreign trade laws.
- The information contained herein is presented only as a guide for the applications of our products. No responsibility is assumed by TOSHIBA CORPORATION for any infringements of intellectual property or other rights of the third parties which may result from its use. No license is granted by implication or otherwise under any intellectual property or other rights of TOSHIBA CORPORATION or others.
- The information contained herein is subject to change without notice.