

165-Bump CCGA & LGA  
 Military Temp

## Rad-Hard SRAM

288Mb/144Mb/72Mb Burst of 4 SigmaQuad-II+™

350 MHz–250 MHz  
 1.8 V V<sub>DD</sub>  
 1.8 V and 1.5 V I/O

### Features

- Aerospace-Level Product
- 2.0 clock Latency with DLL on
- 1.0 clock Latency with DLL off
- Optional DLL-controlled output timing
- Can be operated with DLL on or off
- Simultaneous Read and Write SigmaQuad™ Interface
- JEDEC-standard pinout and package
- Dual Double Data Rate interface
- Byte Write controls sampled at data-in time
- Burst of 4 Read and Write
- Dual-Range On-Die Termination (ODT) on Data (D), Byte Write ( $\overline{BW}$ ), and Clock (K,  $\overline{K}$ ) inputs
- 1.8 V +100/-100 mV core power supply
- 1.5 V or 1.8 V HSTL Interface
- Pipelined read operation
- Fully coherent read and write pipelines
- ZQ pin for programmable output drive strength
- Data Valid Pin (QVLD) Support
- IEEE 1149.1 JTAG-compliant Boundary Scan
- 165-bump Ceramic Column Grid Array (CCGA) and 165-bump Land Grid Array (LGA) packages

### Radiation Performance

- Total Ionizing Dose (TID) > 100krads(Si)
- Single Event Latchup Immunity > 77.3 MeV.cm<sup>2</sup>/mg (125°C)

### SigmaQuad™ Family Overview

The GS82612DT19/37, GS81332DT19/37, and GS8692DT19/37 are built in compliance with the SigmaQuad-II+ SRAM pinout standard for Separate I/O synchronous SRAMs. They are 301,989,888-bit (288Mb), 150,994,944-bit (144Mb), and 75,497,472-bit (72Mb) SRAMs. These SigmaQuad SRAMs are just one element in a family of low power, low voltage HSTL I/O SRAMs designed to operate at the speeds needed to implement economical high performance networking systems.

### Clocking and Addressing Schemes

The Rad-Hard SigmaQuad-II+ SRAMs are synchronous devices. They employ two input register clock inputs, K and  $\overline{K}$ . K and  $\overline{K}$  are independent single-ended clock inputs, not differential inputs to a single differential clock input buffer.

Each internal read and write operation in a SigmaQuad-II+ B4 RAM is four times wider than the device I/O bus. An input data bus de-multiplexer is used to accumulate incoming data before it is simultaneously written to the memory array. An output data multiplexer is used to capture the data produced from a single memory array read and then route it to the appropriate output drivers as needed. Therefore, the address field of a SigmaQuad-II+ B4 RAM is always two address pins less than the advertised index depth (e.g., the 16M x 18 has a 4M addressable index).

### Parameter Synopsis

	-350M	-250M
t <sub>KHKH</sub>	2.86 ns	4.0 ns
t <sub>KHQV</sub>	0.45 ns	0.45 ns

## 16M x 18 SigmaQuad-II+ SRAM—Top View (288Mb)

	1	2	3	4	5	6	7	8	9	10	11
A	$\overline{\text{CQ}}$	SA	SA	$\overline{\text{W}}$	$\overline{\text{BW1}}$	$\overline{\text{K}}$	SA	$\overline{\text{R}}$	SA	SA	CQ
B	NC	Q9	D9	SA	NC	K	$\overline{\text{BW0}}$	SA	NC	NC	Q8
C	NC	NC	D10	V <sub>SS</sub>	SA	NC	SA	V <sub>SS</sub>	NC	Q7	D8
D	NC	D11	Q10	V <sub>SS</sub>	V <sub>SS</sub>	V <sub>SS</sub>	V <sub>SS</sub>	V <sub>SS</sub>	NC	NC	D7
E	NC	NC	Q11	V <sub>DDQ</sub>	V <sub>SS</sub>	V <sub>SS</sub>	V <sub>SS</sub>	V <sub>DDQ</sub>	NC	D6	Q6
F	NC	Q12	D12	V <sub>DDQ</sub>	V <sub>DD</sub>	V <sub>SS</sub>	V <sub>DD</sub>	V <sub>DDQ</sub>	NC	NC	Q5
G	NC	D13	Q13	V <sub>DDQ</sub>	V <sub>DD</sub>	V <sub>SS</sub>	V <sub>DD</sub>	V <sub>DDQ</sub>	NC	NC	D5
H	$\overline{\text{Doff}}$	V <sub>REF</sub>	V <sub>DDQ</sub>	V <sub>DDQ</sub>	V <sub>DD</sub>	V <sub>SS</sub>	V <sub>DD</sub>	V <sub>DDQ</sub>	V <sub>DDQ</sub>	V <sub>REF</sub>	ZQ
J	NC	NC	D14	V <sub>DDQ</sub>	V <sub>DD</sub>	V <sub>SS</sub>	V <sub>DD</sub>	V <sub>DDQ</sub>	NC	Q4	D4
K	NC	NC	Q14	V <sub>DDQ</sub>	V <sub>DD</sub>	V <sub>SS</sub>	V <sub>DD</sub>	V <sub>DDQ</sub>	NC	D3	Q3
L	NC	Q15	D15	V <sub>DDQ</sub>	V <sub>SS</sub>	V <sub>SS</sub>	V <sub>SS</sub>	V <sub>DDQ</sub>	NC	NC	Q2
M	NC	NC	D16	V <sub>SS</sub>	V <sub>SS</sub>	V <sub>SS</sub>	V <sub>SS</sub>	V <sub>SS</sub>	NC	Q1	D2
N	NC	D17	Q16	V <sub>SS</sub>	SA	SA	SA	V <sub>SS</sub>	NC	NC	D1
P	NC	NC	Q17	SA	SA	QVLD	SA	SA	NC	D0	Q0
R	TDO	TCK	SA	SA	SA	ODT	SA	SA	SA	TMS	TDI

11 x 15 Bump CCGA or CLGA—21 x 25 mm Body—1.27 mm Bump Pitch

**Note:**

BW0 controls writes to D0:D8. BW1 controls writes to D9:D17.

## 8M x 36 SigmaQuad-II+ SRAM—Top View (288Mb)

	1	2	3	4	5	6	7	8	9	10	11
A	$\overline{\text{CQ}}$	SA	SA	$\overline{\text{W}}$	$\overline{\text{BW2}}$	$\overline{\text{K}}$	$\overline{\text{BW1}}$	$\overline{\text{R}}$	SA	SA	CQ
B	Q27	Q18	D18	SA	$\overline{\text{BW3}}$	K	$\overline{\text{BW0}}$	SA	D17	Q17	Q8
C	D27	Q28	D19	V <sub>SS</sub>	SA	NC	SA	V <sub>SS</sub>	D16	Q7	D8
D	D28	D20	Q19	V <sub>SS</sub>	V <sub>SS</sub>	V <sub>SS</sub>	V <sub>SS</sub>	V <sub>SS</sub>	Q16	D15	D7
E	Q29	D29	Q20	V <sub>DDQ</sub>	V <sub>SS</sub>	V <sub>SS</sub>	V <sub>SS</sub>	V <sub>DDQ</sub>	Q15	D6	Q6
F	Q30	Q21	D21	V <sub>DDQ</sub>	V <sub>DD</sub>	V <sub>SS</sub>	V <sub>DD</sub>	V <sub>DDQ</sub>	D14	Q14	Q5
G	D30	D22	Q22	V <sub>DDQ</sub>	V <sub>DD</sub>	V <sub>SS</sub>	V <sub>DD</sub>	V <sub>DDQ</sub>	Q13	D13	D5
H	$\overline{\text{Doff}}$	V <sub>REF</sub>	V <sub>DDQ</sub>	V <sub>DDQ</sub>	V <sub>DD</sub>	V <sub>SS</sub>	V <sub>DD</sub>	V <sub>DDQ</sub>	V <sub>DDQ</sub>	V <sub>REF</sub>	ZQ
J	D31	Q31	D23	V <sub>DDQ</sub>	V <sub>DD</sub>	V <sub>SS</sub>	V <sub>DD</sub>	V <sub>DDQ</sub>	D12	Q4	D4
K	Q32	D32	Q23	V <sub>DDQ</sub>	V <sub>DD</sub>	V <sub>SS</sub>	V <sub>DD</sub>	V <sub>DDQ</sub>	Q12	D3	Q3
L	Q33	Q24	D24	V <sub>DDQ</sub>	V <sub>SS</sub>	V <sub>SS</sub>	V <sub>SS</sub>	V <sub>DDQ</sub>	D11	Q11	Q2
M	D33	Q34	D25	V <sub>SS</sub>	V <sub>SS</sub>	V <sub>SS</sub>	V <sub>SS</sub>	V <sub>SS</sub>	D10	Q1	D2
N	D34	D26	Q25	V <sub>SS</sub>	SA	SA	SA	V <sub>SS</sub>	Q10	D9	D1
P	Q35	D35	Q26	SA	SA	QVLD	SA	SA	Q9	D0	Q0
R	TDO	TCK	SA	SA	SA	ODT	SA	SA	SA	TMS	TDI

11 x 15 Bump CCGA or CLGA—21 x 25 mm Body—1.27 mm Bump Pitch

**Note:**
 $\overline{\text{BW0}}$  controls writes to D0:D8;  $\overline{\text{BW1}}$  controls writes to D9:D17;  $\overline{\text{BW2}}$  controls writes to D18:D26;  $\overline{\text{BW3}}$  controls writes to D27:D35

## 8M x 18 SigmaQuad-II+ SRAM—Top View (144Mb)

	1	2	3	4	5	6	7	8	9	10	11
A	$\overline{\text{CQ}}$	SA	SA	$\overline{\text{W}}$	$\overline{\text{BW1}}$	$\overline{\text{K}}$	MCL (288Mb)	$\overline{\text{R}}$	SA	SA	CQ
B	NC	Q9	D9	SA	NC	K	$\overline{\text{BW0}}$	SA	NC	NC	Q8
C	NC	NC	D10	$V_{SS}$	SA	NC	SA	$V_{SS}$	NC	Q7	D8
D	NC	D11	Q10	$V_{SS}$	$V_{SS}$	$V_{SS}$	$V_{SS}$	$V_{SS}$	NC	NC	D7
E	NC	NC	Q11	$V_{DDQ}$	$V_{SS}$	$V_{SS}$	$V_{SS}$	$V_{DDQ}$	NC	D6	Q6
F	NC	Q12	D12	$V_{DDQ}$	$V_{DD}$	$V_{SS}$	$V_{DD}$	$V_{DDQ}$	NC	NC	Q5
G	NC	D13	Q13	$V_{DDQ}$	$V_{DD}$	$V_{SS}$	$V_{DD}$	$V_{DDQ}$	NC	NC	D5
H	$\overline{\text{Doff}}$	$V_{REF}$	$V_{DDQ}$	$V_{DDQ}$	$V_{DD}$	$V_{SS}$	$V_{DD}$	$V_{DDQ}$	$V_{DDQ}$	$V_{REF}$	ZQ
J	NC	NC	D14	$V_{DDQ}$	$V_{DD}$	$V_{SS}$	$V_{DD}$	$V_{DDQ}$	NC	Q4	D4
K	NC	NC	Q14	$V_{DDQ}$	$V_{DD}$	$V_{SS}$	$V_{DD}$	$V_{DDQ}$	NC	D3	Q3
L	NC	Q15	D15	$V_{DDQ}$	$V_{SS}$	$V_{SS}$	$V_{SS}$	$V_{DDQ}$	NC	NC	Q2
M	NC	NC	D16	$V_{SS}$	$V_{SS}$	$V_{SS}$	$V_{SS}$	$V_{SS}$	NC	Q1	D2
N	NC	D17	Q16	$V_{SS}$	SA	SA	SA	$V_{SS}$	NC	NC	D1
P	NC	NC	Q17	SA	SA	QVLD	SA	SA	NC	D0	Q0
R	TDO	TCK	SA	SA	SA	ODT	SA	SA	SA	TMS	TDI

11 x 15 Bump CCGA or CLGA—21 x 25 mm Body—1.27 mm Bump Pitch

**Note:**
 $\overline{\text{BW0}}$  controls writes to D0:D8.  $\overline{\text{BW1}}$  controls writes to D9:D17

## 4M x 36 SigmaQuad-II+ SRAM—Top View (144Mb)

	1	2	3	4	5	6	7	8	9	10	11
A	$\overline{\text{CQ}}$	MCL (288Mb)	SA	$\overline{\text{W}}$	$\overline{\text{BW2}}$	$\overline{\text{K}}$	$\overline{\text{BW1}}$	$\overline{\text{R}}$	SA	SA	CQ
B	Q27	Q18	D18	SA	$\overline{\text{BW3}}$	K	$\overline{\text{BW0}}$	SA	D17	Q17	Q8
C	D27	Q28	D19	V <sub>SS</sub>	SA	NC	SA	V <sub>SS</sub>	D16	Q7	D8
D	D28	D20	Q19	V <sub>SS</sub>	V <sub>SS</sub>	V <sub>SS</sub>	V <sub>SS</sub>	V <sub>SS</sub>	Q16	D15	D7
E	Q29	D29	Q20	V <sub>DDQ</sub>	V <sub>SS</sub>	V <sub>SS</sub>	V <sub>SS</sub>	V <sub>DDQ</sub>	Q15	D6	Q6
F	Q30	Q21	D21	V <sub>DDQ</sub>	V <sub>DD</sub>	V <sub>SS</sub>	V <sub>DD</sub>	V <sub>DDQ</sub>	D14	Q14	Q5
G	D30	D22	Q22	V <sub>DDQ</sub>	V <sub>DD</sub>	V <sub>SS</sub>	V <sub>DD</sub>	V <sub>DDQ</sub>	Q13	D13	D5
H	$\overline{\text{Doff}}$	V <sub>REF</sub>	V <sub>DDQ</sub>	V <sub>DDQ</sub>	V <sub>DD</sub>	V <sub>SS</sub>	V <sub>DD</sub>	V <sub>DDQ</sub>	V <sub>DDQ</sub>	V <sub>REF</sub>	ZQ
J	D31	Q31	D23	V <sub>DDQ</sub>	V <sub>DD</sub>	V <sub>SS</sub>	V <sub>DD</sub>	V <sub>DDQ</sub>	D12	Q4	D4
K	Q32	D32	Q23	V <sub>DDQ</sub>	V <sub>DD</sub>	V <sub>SS</sub>	V <sub>DD</sub>	V <sub>DDQ</sub>	Q12	D3	Q3
L	Q33	Q24	D24	V <sub>DDQ</sub>	V <sub>SS</sub>	V <sub>SS</sub>	V <sub>SS</sub>	V <sub>DDQ</sub>	D11	Q11	Q2
M	D33	Q34	D25	V <sub>SS</sub>	V <sub>SS</sub>	V <sub>SS</sub>	V <sub>SS</sub>	V <sub>SS</sub>	D10	Q1	D2
N	D34	D26	Q25	V <sub>SS</sub>	SA	SA	SA	V <sub>SS</sub>	Q10	D9	D1
P	Q35	D35	Q26	SA	SA	QVLD	SA	SA	Q9	D0	Q0
R	TDO	TCK	SA	SA	SA	ODT	SA	SA	SA	TMS	TDI

11 x 15 Bump CCGA or CLGA—21 x 25 mm Body—1.27 mm Bump Pitch

**Note:**

 BW0 controls writes to D0:D8;  $\overline{\text{BW1}}$  controls writes to D9:D17;  $\overline{\text{BW2}}$  controls writes to D18:D26;  $\overline{\text{BW3}}$  controls writes to D27:D35

4M x 18 SigmaQuad-II+ SRAM—Top View (72Mb)

	1	2	3	4	5	6	7	8	9	10	11
A	$\overline{\text{CQ}}$	MCL (144Mb)	SA	$\overline{\text{W}}$	$\overline{\text{BW1}}$	$\overline{\text{K}}$	MCL (288Mb)	$\overline{\text{R}}$	SA	SA	CQ
B	NC	Q9	D9	SA	NC	K	$\overline{\text{BW0}}$	SA	NC	NC	Q8
C	NC	NC	D10	$V_{SS}$	SA	NC	SA	$V_{SS}$	NC	Q7	D8
D	NC	D11	Q10	$V_{SS}$	$V_{SS}$	$V_{SS}$	$V_{SS}$	$V_{SS}$	NC	NC	D7
E	NC	NC	Q11	$V_{DDQ}$	$V_{SS}$	$V_{SS}$	$V_{SS}$	$V_{DDQ}$	NC	D6	Q6
F	NC	Q12	D12	$V_{DDQ}$	$V_{DD}$	$V_{SS}$	$V_{DD}$	$V_{DDQ}$	NC	NC	Q5
G	NC	D13	Q13	$V_{DDQ}$	$V_{DD}$	$V_{SS}$	$V_{DD}$	$V_{DDQ}$	NC	NC	D5
H	$\overline{\text{Doff}}$	$V_{REF}$	$V_{DDQ}$	$V_{DDQ}$	$V_{DD}$	$V_{SS}$	$V_{DD}$	$V_{DDQ}$	$V_{DDQ}$	$V_{REF}$	ZQ
J	NC	NC	D14	$V_{DDQ}$	$V_{DD}$	$V_{SS}$	$V_{DD}$	$V_{DDQ}$	NC	Q4	D4
K	NC	NC	Q14	$V_{DDQ}$	$V_{DD}$	$V_{SS}$	$V_{DD}$	$V_{DDQ}$	NC	D3	Q3
L	NC	Q15	D15	$V_{DDQ}$	$V_{SS}$	$V_{SS}$	$V_{SS}$	$V_{DDQ}$	NC	NC	Q2
M	NC	NC	D16	$V_{SS}$	$V_{SS}$	$V_{SS}$	$V_{SS}$	$V_{SS}$	NC	Q1	D2
N	NC	D17	Q16	$V_{SS}$	SA	SA	SA	$V_{SS}$	NC	NC	D1
P	NC	NC	Q17	SA	SA	QVLD	SA	SA	NC	D0	Q0
R	TDO	TCK	SA	SA	SA	ODT	SA	SA	SA	TMS	TDI

11 x 15 Bump CCGA or CLGA—21 x 25 mm Body—1.27 mm Bump Pitch

**Note:**

$\overline{\text{BW0}}$  controls writes to D0:D8.  $\overline{\text{BW1}}$  controls writes to D9:D17

## 2M x 36 SigmaQuad-II+ SRAM—Top View (72Mb)

	1	2	3	4	5	6	7	8	9	10	11
A	$\overline{\text{CQ}}$	MCL (288Mb)	SA	$\overline{\text{W}}$	$\overline{\text{BW2}}$	$\overline{\text{K}}$	$\overline{\text{BW1}}$	$\overline{\text{R}}$	SA	MCL (144Mb)	CQ
B	Q27	Q18	D18	SA	$\overline{\text{BW3}}$	K	$\overline{\text{BW0}}$	SA	D17	Q17	Q8
C	D27	Q28	D19	V <sub>SS</sub>	SA	NC	SA	V <sub>SS</sub>	D16	Q7	D8
D	D28	D20	Q19	V <sub>SS</sub>	V <sub>SS</sub>	V <sub>SS</sub>	V <sub>SS</sub>	V <sub>SS</sub>	Q16	D15	D7
E	Q29	D29	Q20	V <sub>DDQ</sub>	V <sub>SS</sub>	V <sub>SS</sub>	V <sub>SS</sub>	V <sub>DDQ</sub>	Q15	D6	Q6
F	Q30	Q21	D21	V <sub>DDQ</sub>	V <sub>DD</sub>	V <sub>SS</sub>	V <sub>DD</sub>	V <sub>DDQ</sub>	D14	Q14	Q5
G	D30	D22	Q22	V <sub>DDQ</sub>	V <sub>DD</sub>	V <sub>SS</sub>	V <sub>DD</sub>	V <sub>DDQ</sub>	Q13	D13	D5
H	$\overline{\text{Doff}}$	V <sub>REF</sub>	V <sub>DDQ</sub>	V <sub>DDQ</sub>	V <sub>DD</sub>	V <sub>SS</sub>	V <sub>DD</sub>	V <sub>DDQ</sub>	V <sub>DDQ</sub>	V <sub>REF</sub>	ZQ
J	D31	Q31	D23	V <sub>DDQ</sub>	V <sub>DD</sub>	V <sub>SS</sub>	V <sub>DD</sub>	V <sub>DDQ</sub>	D12	Q4	D4
K	Q32	D32	Q23	V <sub>DDQ</sub>	V <sub>DD</sub>	V <sub>SS</sub>	V <sub>DD</sub>	V <sub>DDQ</sub>	Q12	D3	Q3
L	Q33	Q24	D24	V <sub>DDQ</sub>	V <sub>SS</sub>	V <sub>SS</sub>	V <sub>SS</sub>	V <sub>DDQ</sub>	D11	Q11	Q2
M	D33	Q34	D25	V <sub>SS</sub>	V <sub>SS</sub>	V <sub>SS</sub>	V <sub>SS</sub>	V <sub>SS</sub>	D10	Q1	D2
N	D34	D26	Q25	V <sub>SS</sub>	SA	SA	SA	V <sub>SS</sub>	Q10	D9	D1
P	Q35	D35	Q26	SA	SA	QVLD	SA	SA	Q9	D0	Q0
R	TDO	TCK	SA	SA	SA	ODT	SA	SA	SA	TMS	TDI

11 x 15 Bump CCGA or CLGA—21 x 25 mm Body—1.27 mm Bump Pitch

**Note:**
 $\overline{\text{BW0}}$  controls writes to D0:D8;  $\overline{\text{BW1}}$  controls writes to D9:D17;  $\overline{\text{BW2}}$  controls writes to D18:D26;  $\overline{\text{BW3}}$  controls writes to D27:D35

## Pin Description Table

Symbol	Description	Type	Comments
SA	Synchronous Address Inputs	Input	—
$\overline{R}$	Synchronous Read	Input	Active Low
$\overline{W}$	Synchronous Write	Input	Active Low
$\overline{BW0}$ – $\overline{BW3}$	Synchronous Byte Writes	Input	Active Low
K	Input Clock	Input	Active High
$\overline{K}$	Input Clock	Input	Active Low
TMS	Test Mode Select	Input	—
TDI	Test Data Input	Input	—
TCK	Test Clock Input	Input	—
TDO	Test Data Output	Output	—
V <sub>REF</sub>	HSTL Input Reference Voltage	Input	—
ZQ	Output Impedance Matching Input	Input	—
Q <sub>n</sub>	Synchronous Data Outputs	Output	—
D <sub>n</sub>	Synchronous Data Inputs	Input	—
$\overline{Doff}$	Disable DLL when low	Input	Active Low
CQ	Output Echo Clock	Output	—
$\overline{CQ}$	Output Echo Clock	Output	—
V <sub>DD</sub>	Power Supply	Supply	1.8 V Nominal
V <sub>DDQ</sub>	Isolated Output Buffer Supply	Supply	1.8 V or 1.5 V Nominal
V <sub>SS</sub>	Power Supply: Ground	Supply	—
QVLD	Q Valid Output	Output	—
ODT	On-Die Termination	Input	Low = Low Impedance Range High/Float = High Impedance Range
NC	No Connect	—	—
MCL	Must Connect Low	Input	May be tied to V <sub>SS</sub> directly or via a 1k $\Omega$ resistor.

### Notes:

1. NC = Not Connected to die or any other pin
2. When ZQ pin is directly connected to V<sub>DDQ</sub>, output impedance is set to minimum value and it cannot be connected to ground or left unconnected.
3. K and  $\overline{K}$  cannot be set to V<sub>REF</sub> voltage.



## Process Flow

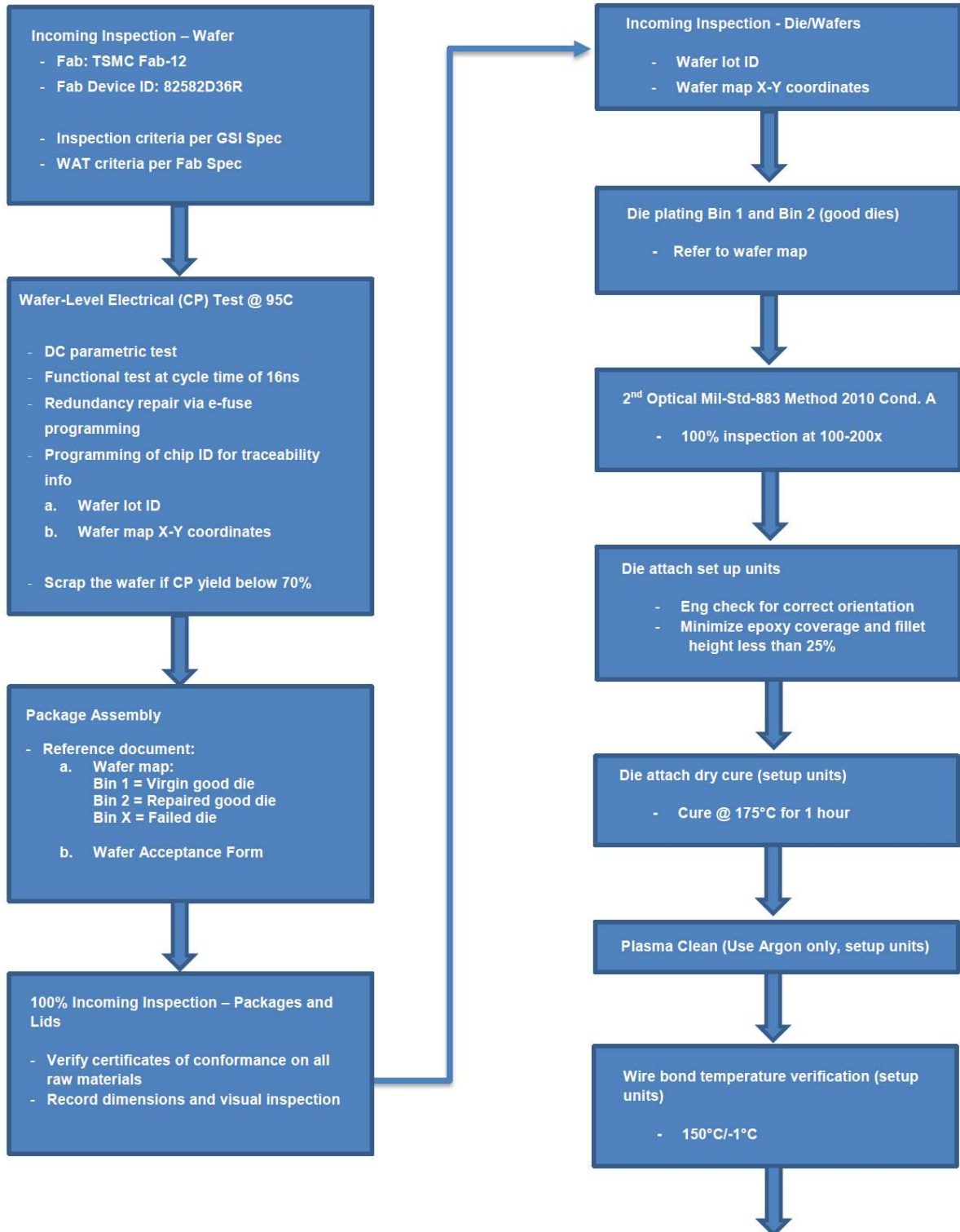

### Process Flow (Continued)

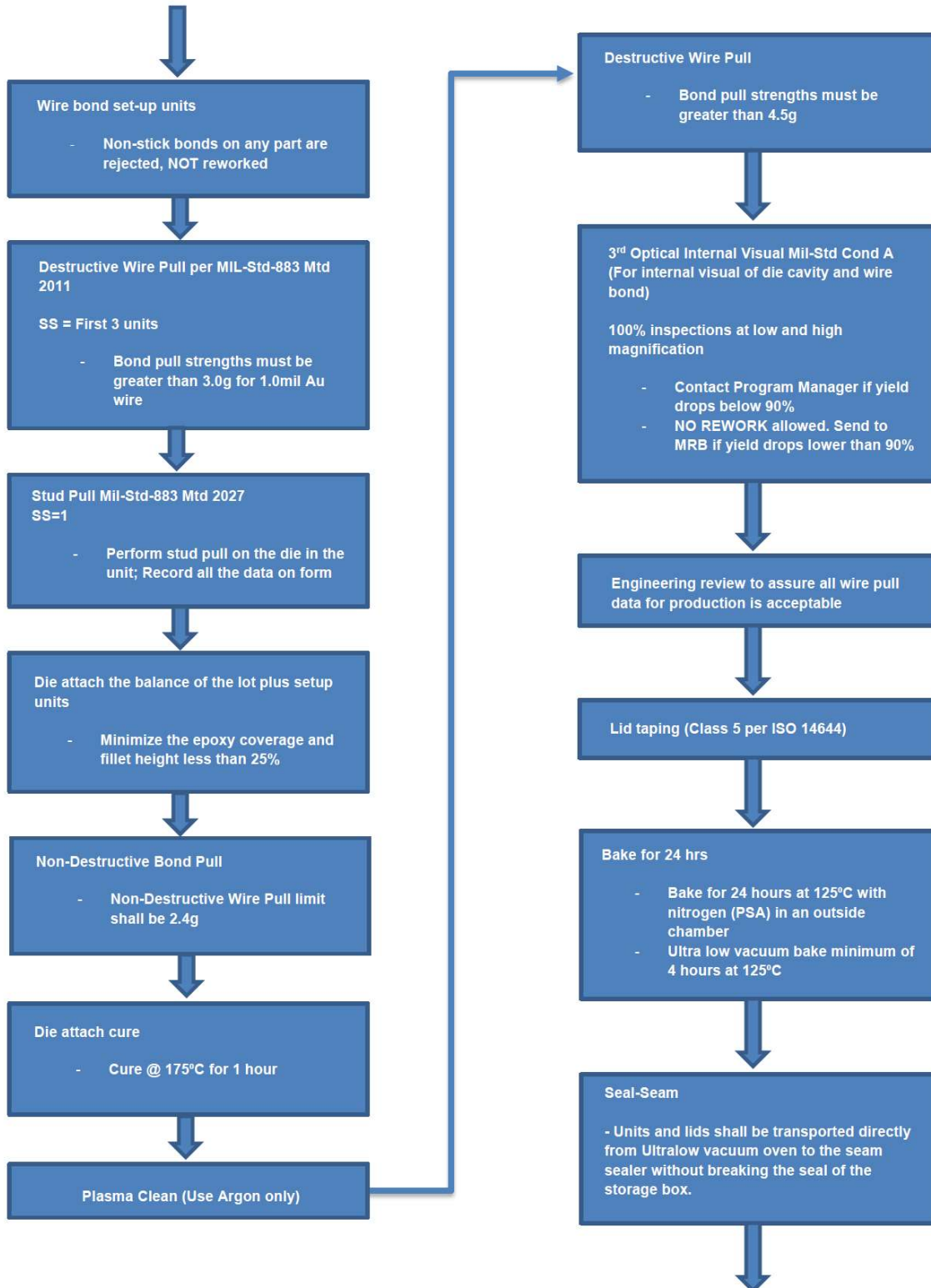

Process Flow (Continued)

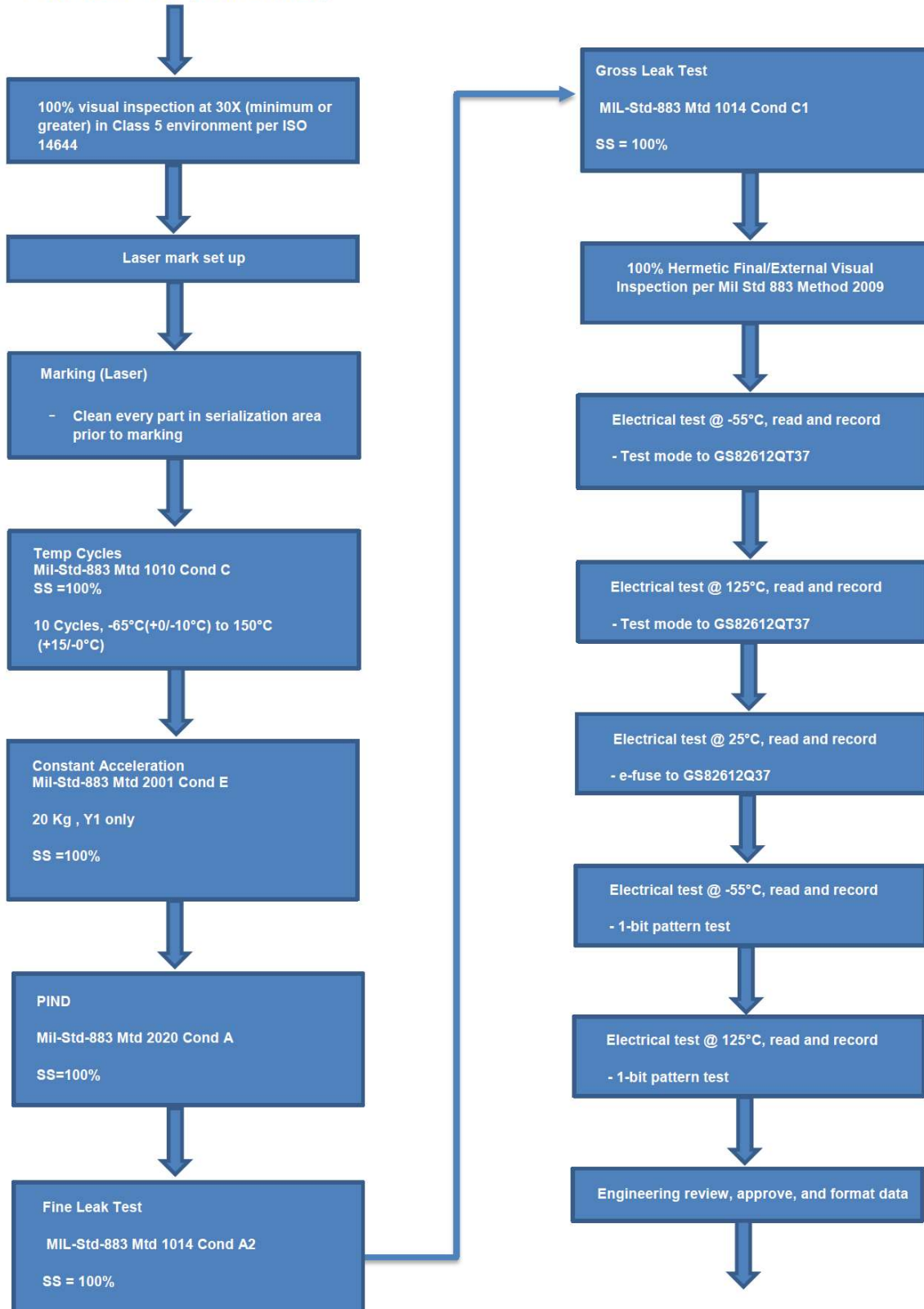

### Process Flow (Continued)

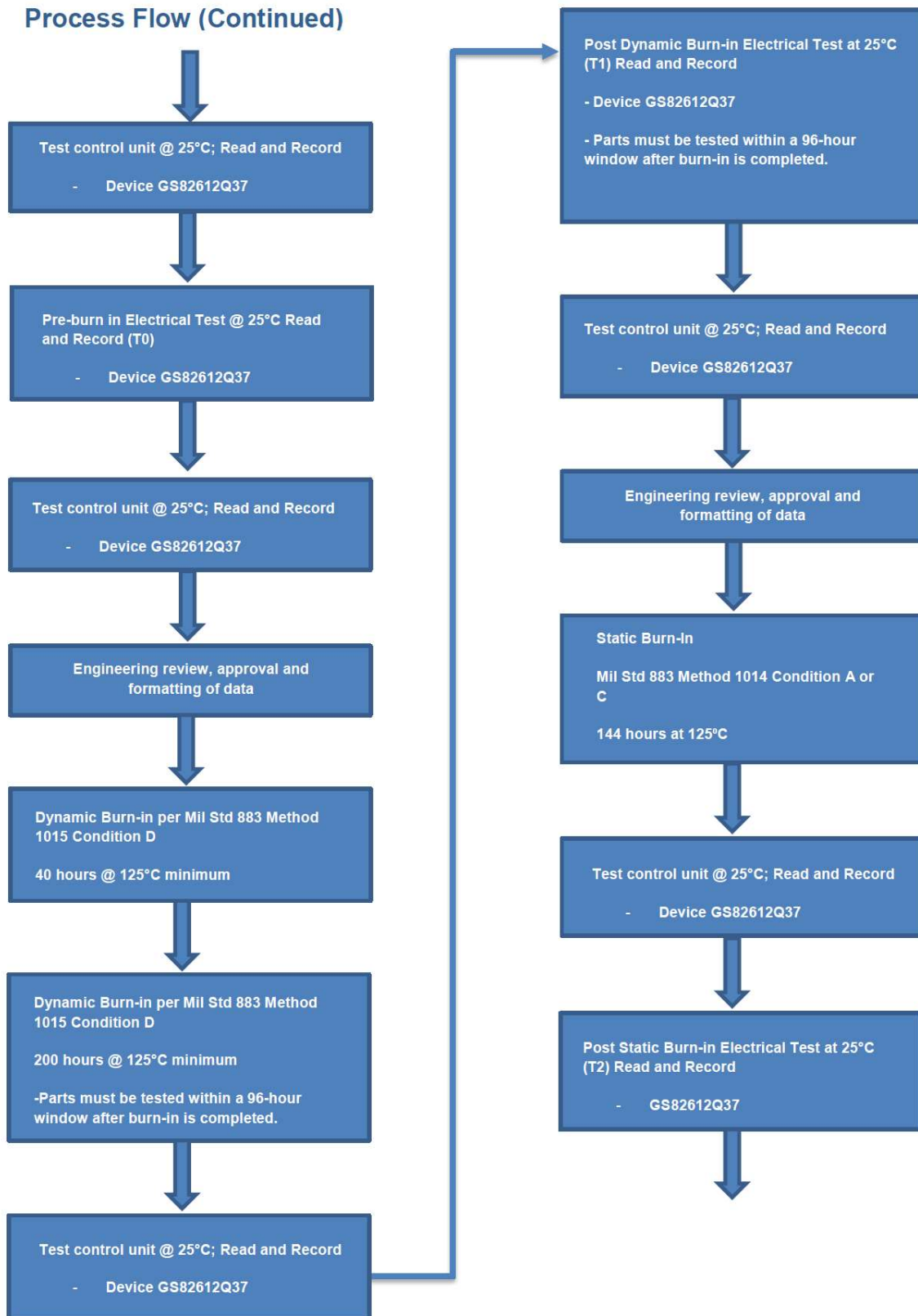

### Process Flow (Continued)

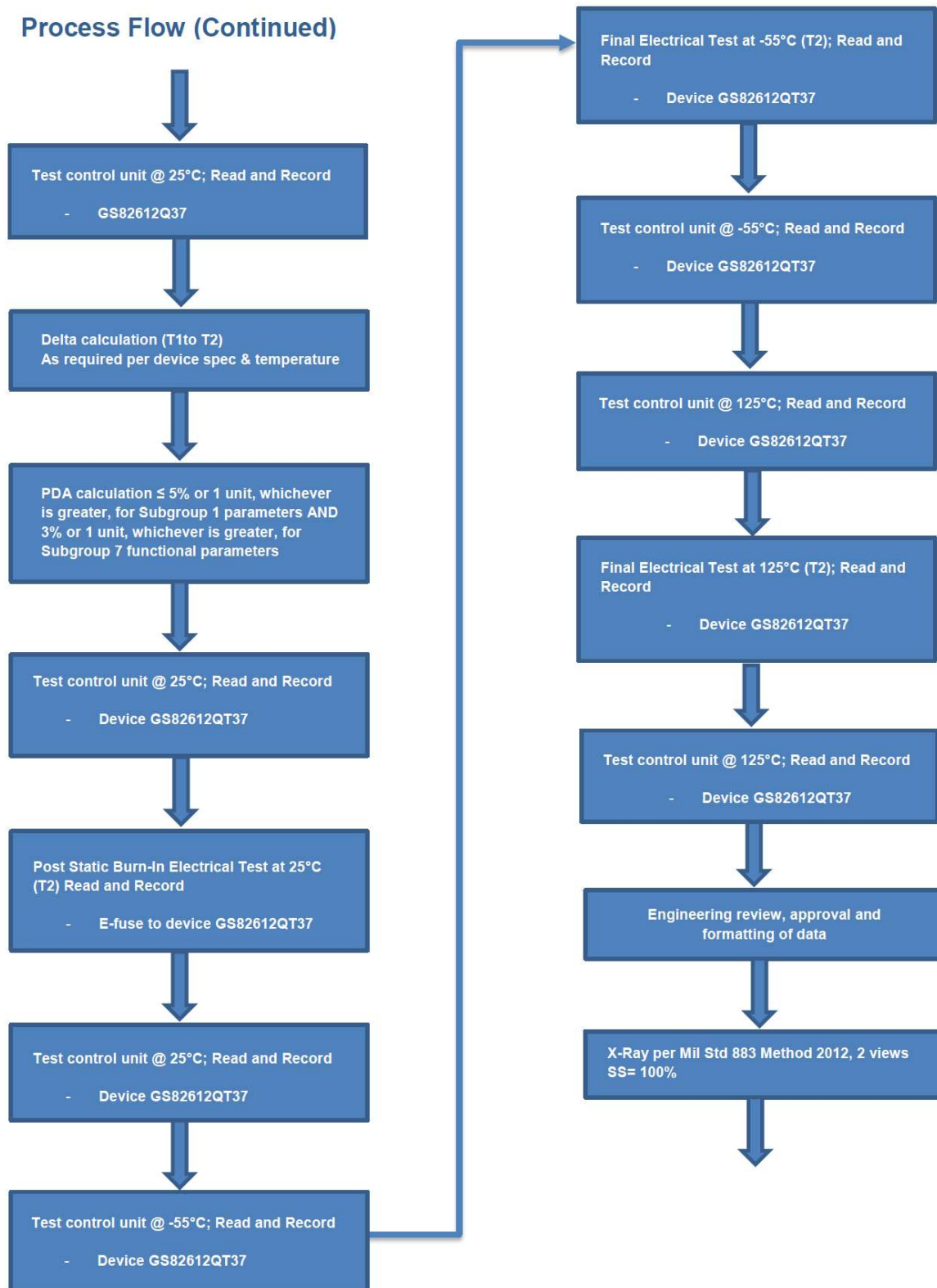

**Process Flow (Continued)**

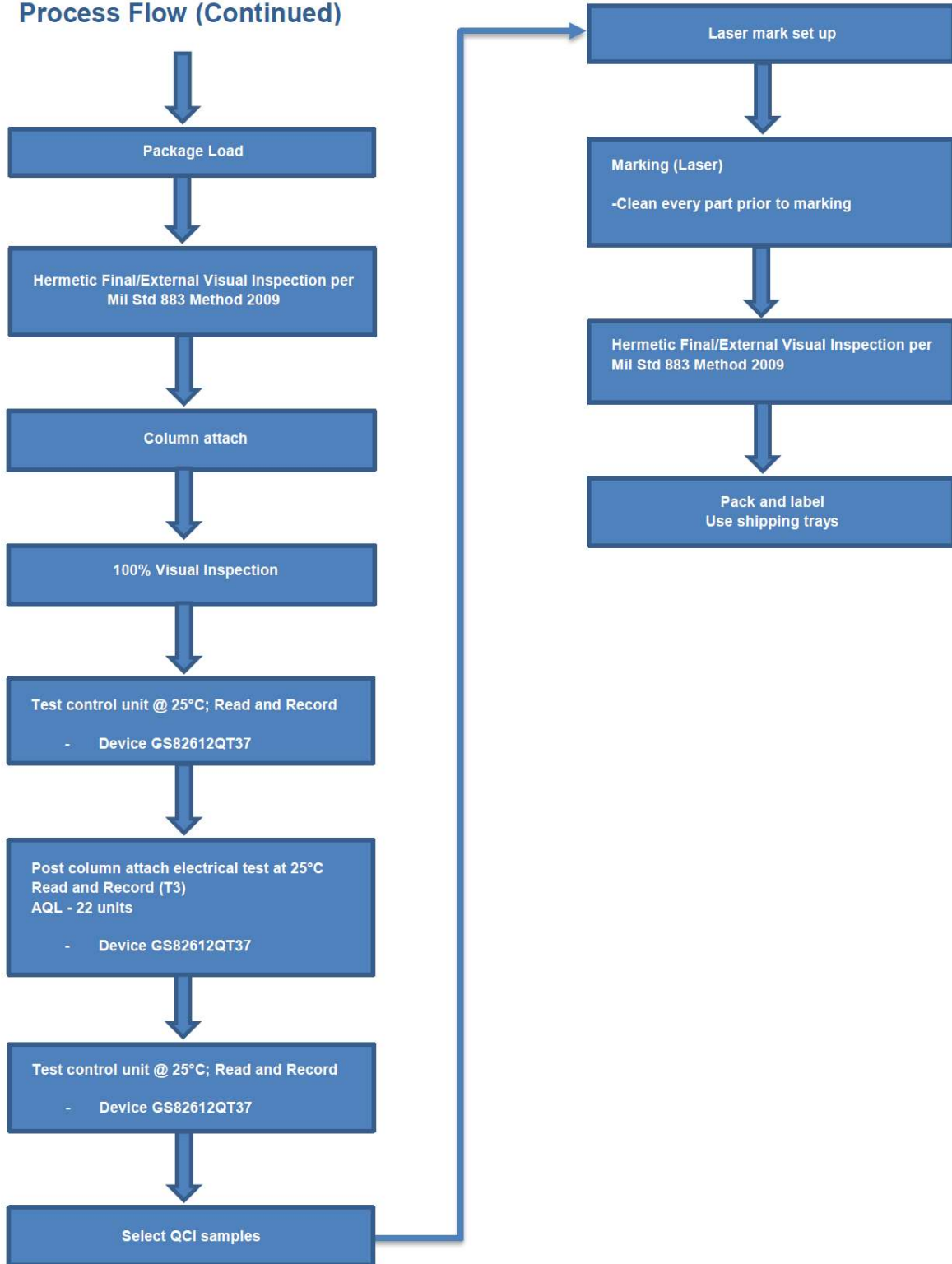

## Background

Separate I/O SRAMs, from a system architecture point of view, are attractive in applications where alternating reads and writes are needed. Therefore, the SigmaQuad-II+ SRAM interface and truth table are optimized for alternating reads and writes. Separate I/O SRAMs are unpopular in applications where multiple reads or multiple writes are needed because burst read or write transfers from Separate I/O SRAMs can cut the RAM's bandwidth in half.

### SigmaQuad-II+ B4 SRAM DDR Read

The status of the Address Input,  $\overline{W}$ , and  $\overline{R}$  pins are sampled by the rising edges of K.  $\overline{W}$  and  $\overline{R}$  high causes chip disable. A Low on the Read Enable pin,  $\overline{R}$ , begins a read cycle.  $\overline{R}$  is always ignored if the previous command loaded was a read command. Clocking in a High on the Read Enable pin,  $\overline{R}$ , begins a read port deselect cycle.

### SRAM DDR Write

The status of the Address Input,  $\overline{W}$ , and  $\overline{R}$  pins are sampled by the rising edges of K.  $\overline{W}$  and  $\overline{R}$  High causes chip disable. A Low on the Write Enable pin,  $\overline{W}$ , and a High on the Read Enable pin,  $\overline{R}$ , begins a write cycle.  $\overline{W}$  is always ignored if the previous command was a write command. Data is clocked in by the next rising edge of K, the rising edge of  $\overline{K}$  after that, the next rising edge of K, and finally by the next rising edge of  $\overline{K}$ .

## Special Functions

### Byte Write Control

Byte Write Enable pins are sampled at the same time that Data In is sampled. A High on the Byte Write Enable pin associated with a particular byte (e.g.,  $\overline{BW0}$  controls D0–D8 inputs) will inhibit the storage of that particular byte, leaving whatever data may be stored at the current address at that byte location undisturbed. Any or all of the Byte Write Enable pins may be driven High or Low during the data in sample times in a write sequence.

Each write enable command and write address loaded into the RAM provides the base address for a 4-beat data transfer. The x18 version of the RAM, for example, may write 72 bits in association with each address loaded. Any 9-bit byte may be masked in any write sequence.

### Example x18 RAM Write Sequence using Byte Write Enables

Data In Sample Time	$\overline{BW0}$	$\overline{BW1}$	D0–D8	D9–D17
Beat 1	0	1	Data In	Don't Care
Beat 2	1	0	Don't Care	Data In
Beat 3	0	0	Data In	Data In
Beat 4	1	0	Don't Care	Data In

### Resulting Write Operation

Byte 1 D0–D8	Byte 2 D9–D17	Byte 1 D0–D8	Byte 2 D9–D17	Byte 1 D0–D8	Byte 2 D9–D17	Byte 1 D0–D8	Byte 2 D9–D17
Written	Unchanged	Unchanged	Written	Written	Written	Unchanged	Written
Beat 1		Beat 2		Beat 3		Beat 4	

### FLXDrive-II Output Driver Impedance Control

HSTL I/O SigmaQuad-II+ SRAMs are supplied with programmable impedance output drivers. The ZQ pin must be connected to  $V_{SS}$  via an external resistor, RQ, to allow the SRAM to monitor and adjust its output driver impedance. The value of RQ must be 5X the value of the desired RAM output impedance. The allowable range of RQ to guarantee impedance matching continuously is between  $175\Omega$  and  $350\Omega$ . Periodic readjustment of the output driver impedance is necessary as the impedance is affected by drifts in supply voltage and temperature. The SRAM's output impedance circuitry compensates for drifts in supply voltage and temperature. A clock cycle counter periodically triggers an impedance evaluation, resets and counts again. Each impedance evaluation may move the output driver impedance level one step at a time towards the optimum level. The output driver is implemented with discrete binary weighted impedance steps.

### Input Termination Impedance Control

These SigmaQuad-II+ SRAMs are supplied with programmable input termination on Data (D), Byte Write ( $\overline{BW}$ ), and Clock (K,  $\overline{K}$ ) input receivers. The input termination is always enabled, and the impedance is programmed via the same RQ resistor (connected between the ZQ pin and  $V_{SS}$ ) used to program output driver impedance, in conjunction with the ODT pin (6R). When the ODT pin is tied Low, input termination is "strong" (i.e., low impedance), and is nominally equal to  $RQ*0.3$  Thevenin-equivalent when RQ is between  $175\Omega$  and  $350\Omega$ . When the ODT pin is tied High (or left floating—the pin has a small pull-up resistor), input termination is "weak" (i.e., high impedance), and is nominally equal to  $RQ*0.6$  Thevenin-equivalent when RQ is between  $175\Omega$  and  $250\Omega$ . Periodic readjustment of the termination impedance occurs to compensate for drifts in supply voltage and temperature, in the same manner as for driver impedance (see above).

#### Note:

D,  $\overline{BW}$ , K,  $\overline{K}$  inputs should always be driven High or Low; they should never be tri-stated (i.e., in a High-Z state). If the inputs are tri-stated, the input termination will pull the signal to  $V_{DDQ}/2$  (i.e., to the switch point of the diff-amp receiver), which could cause the receiver to enter a meta-stable state, resulting in the receiver consuming more power than it normally would. This could result in the device's operating currents being higher.

### Power-Up Initialization

After power-up, stable input clocks must be applied to the device for  $20\ \mu\text{s}$  prior to issuing read and write commands. See the  $t_{KInit}$  timing parameter in the **AC Electrical Characteristics** section.

#### Note:

The  $t_{KInit}$  requirement is independent of the  $t_{Lock}$  requirement, which specifies how many cycles of stable input clocks (2048) must be applied after the  $\overline{Doff}$  pin has been driven High in order to ensure that the DLL locks properly (and the DLL must lock properly before issuing read and write commands if the device is being operated with the DLL on). However,  $t_{KInit}$  is greater than  $t_{KLock}$ , even at the slowest permitted cycle time of  $8.4\ \text{ns}$  ( $2048*8.4\ \text{ns} = 17.2\ \mu\text{s}$ ). Consequently, the  $20\ \mu\text{s}$  associated with  $t_{KInit}$  is sufficient to cover the  $t_{KLock}$  requirement at power-up if the  $\overline{Doff}$  pin is driven High prior to the start of the  $20\ \mu\text{s}$  period.

Also,  $t_{KInit}$  only needs to be met once, immediately after power-up, whereas  $t_{KLock}$  must be met any time the DLL is disabled/reset (whether by toggling  $\overline{Doff}$  Low or by stopping K clocks for  $> 30\ \text{ns}$ ).



**Separate I/O SigmaQuad II+ B4 SRAM Truth Table**

Previous Operation	A	$\bar{R}$	$\bar{W}$	Current Operation	D	D	D	D	Q	Q	Q	Q
$K \uparrow$ ( $t_{n-1}$ )	$K \uparrow$ ( $t_n$ )	$K \uparrow$ ( $t_n$ )	$K \uparrow$ ( $t_n$ )	$K \uparrow$ ( $t_n$ )	$K \uparrow$ ( $t_{n+1}$ )	$\bar{K} \uparrow$ ( $t_{n+1/2}$ )	$K \uparrow$ ( $t_{n+2}$ )	$\bar{K} \uparrow$ ( $t_{n+2/2}$ )	$K \uparrow$ ( $t_{n+2}$ )	$\bar{K} \uparrow$ ( $t_{n+2/2}$ )	$K \uparrow$ ( $t_{n+3}$ )	$\bar{K} \uparrow$ ( $t_{n+3/2}$ )
Deselect	X	1	1	Deselect	X	X	—	—	Hi-Z	Hi-Z	—	—
Write	X	1	X	Deselect	D2	D3	—	—	Hi-Z	Hi-Z	—	—
Read	X	X	1	Deselect	X	X	—	—	Q2	Q3	—	—
Deselect	V	1	0	Write	D0	D1	D2	D3	Hi-Z	Hi-Z	—	—
Deselect	V	0	X	Read	X	X	—	—	Q0	Q1	Q2	Q3
Read	V	X	0	Write	D0	D1	D2	D3	Q2	Q3	—	—
Write	V	0	X	Read	D2	D3	—	—	Q0	Q1	Q2	Q3

**Notes:**

1. "1" = input "high"; "0" = input "low"; "V" = input "valid"; "X" = input "don't care"
2. "—" indicates that the input requirement or output state is determined by the next operation.
3. Q0, Q1, Q2, and Q3 indicate the first, second, third, and fourth pieces of output data transferred during Read operations.
4. D0, D1, D2, and D3 indicate the first, second, third, and fourth pieces of input data transferred during Write operations.
5. Users should not clock in metastable addresses.

**x36 Byte Write Enable ( $\overline{BWn}$ ) Truth Table**

$\overline{BW0}$	$\overline{BW1}$	$\overline{BW2}$	$\overline{BW3}$	D0–D8	D9–D17	D18–D26	D27–D35
1	1	1	1	Don't Care	Don't Care	Don't Care	Don't Care
0	1	1	1	Data In	Don't Care	Don't Care	Don't Care
1	0	1	1	Don't Care	Data In	Don't Care	Don't Care
0	0	1	1	Data In	Data In	Don't Care	Don't Care
1	1	0	1	Don't Care	Don't Care	Data In	Don't Care
0	1	0	1	Data In	Don't Care	Data In	Don't Care
1	0	0	1	Don't Care	Data In	Data In	Don't Care
0	0	0	1	Data In	Data In	Data In	Don't Care
1	1	1	0	Don't Care	Don't Care	Don't Care	Data In
0	1	1	0	Data In	Don't Care	Don't Care	Data In
1	0	1	0	Don't Care	Data In	Don't Care	Data In
0	0	1	0	Data In	Data In	Don't Care	Data In
1	1	0	0	Don't Care	Don't Care	Data In	Data In
0	1	0	0	Data In	Don't Care	Data In	Data In
1	0	0	0	Don't Care	Data In	Data In	Data In
0	0	0	0	Data In	Data In	Data In	Data In

**x18 Byte Write Enable ( $\overline{BWn}$ ) Truth Table**

$\overline{BW0}$	$\overline{BW1}$	D0–D8	D9–D17
1	1	Don't Care	Don't Care
0	1	Data In	Don't Care
1	0	Don't Care	Data In
0	0	Data In	Data In

## Absolute Maximum Ratings

(All voltages reference to  $V_{SS}$ )

Symbol	Description	Value	Unit
$V_{DD}$	Voltage on $V_{DD}$ Pins	-0.5 to 2.9	V
$V_{DDQ}$	Voltage in $V_{DDQ}$ Pins	-0.5 to $V_{DD}$	V
$V_{REF}$	Voltage in $V_{REF}$ Pins	-0.5 to $V_{DDQ}$	V
$V_{I/O}$	Voltage on I/O Pins	-0.5 to $V_{DDQ} + 0.5$ ( $\leq 2.9$ V max.)	V
$V_{IN}$	Input Voltage (Address, Control, Data, Clock)	-0.5 to $V_{DDQ} + 0.5$ ( $\leq 2.9$ V max.)	V
$V_{TIN}$	Input Voltage (TCK, TMS, TDI)	-0.5 to $V_{DDQ} + 0.5$ ( $\leq 2.9$ V max.)	V
$I_{IN}$	Input Current on Any Pin	+/-100	mA dc
$I_{OUT}$	Output Current on Any I/O Pin	+/-100	mA dc
$T_J$	Maximum Junction Temperature	125	$^{\circ}$ C
$T_{STG}$	Storage Temperature	-65 to 150	$^{\circ}$ C

### Note:

Permanent damage to the device may occur if the Absolute Maximum Ratings are exceeded. Operation should be restricted to Recommended Operating Conditions. Exposure to conditions exceeding the Recommended Operating Conditions, for an extended period of time, may affect reliability of this component.

## Recommended Operating Conditions

### Power Supplies

Parameter	Symbol	Min.	Typ.	Max.	Unit
Supply Voltage	$V_{DD}$	1.7	1.8	1.9	V
I/O Supply Voltage	$V_{DDQ}$	1.4	—	$V_{DD}$	V
Reference Voltage	$V_{REF}$	$V_{DDQ}/2 - 0.05$	—	$V_{DDQ}/2 + 0.05$	V

### Note:

$V_{DD}$ ,  $V_{DDQ}$ , and  $V_{REF}$  can be powered up or down in any sequence.

### Operating Temperature

Parameter	Symbol	Min.	Typ.	Max.	Unit
Junction Temperature	$T_J$	-55	25	125	$^{\circ}$ C

## Thermal Impedance

Package	Test PCB Substrate	$\theta_{JA}$ (C°/W) Airflow = 0 m/s	$\theta_{JC}$ (C°/W)
165 CCGA & LGA	4-layer	20.2316	8.8057

### Notes:

1. Thermal Impedance data is based on a number of samples from multiple lots and should be viewed as a typical number.
2. Please refer to JEDEC standard JESD51-6.
3. The characteristics of the test fixture PCB influence reported thermal characteristics of the device. Be advised that a good thermal path to the PCB can result in cooling or heating of the RAM depending on PCB temperature.

## HSTL I/O DC Input Characteristics

Parameter	Symbol	Min	Max	Units	Notes
Input Reference Voltage	$V_{REF}$	$V_{DDQ}/2 - 0.05$	$V_{DDQ}/2 + 0.05$	V	—
Input High Voltage	$V_{IH1}$	$V_{REF} + 0.1$	$V_{DDQ} + 0.3$	V	1
Input Low Voltage	$V_{IL1}$	-0.3	$V_{REF} - 0.1$	V	1
Input High Voltage	$V_{IH2}$	$0.7 * V_{DDQ}$	$V_{DDQ} + 0.3$	V	2,3
Input Low Voltage	$V_{IL2}$	-0.3	$0.3 * V_{DDQ}$	V	2,3

### Notes:

1. Parameters apply to  $\overline{K}$ ,  $\overline{K}$ , SA, D,  $\overline{R}$ ,  $\overline{W}$ ,  $\overline{BW}$  during normal operation and JTAG boundary scan testing.
2. Parameters apply to Doff, ODT during normal operation and JTAG boundary scan testing.
3. Parameters apply to ZQ during JTAG boundary scan testing only.

## HSTL I/O AC Input Characteristics

Parameter	Symbol	Min	Max	Units	Notes
Input Reference Voltage	$V_{REF}$	$V_{DDQ}/2 - 0.08$	$V_{DDQ}/2 + 0.08$	V	—
Input High Voltage	$V_{IH1}$	$V_{REF} + 0.2$	$V_{DDQ} + 0.5$	V	1,2,3
Input Low Voltage	$V_{IL1}$	-0.5	$V_{REF} - 0.2$	V	1,2,3
Input High Voltage	$V_{IH2}$	$V_{DDQ} - 0.2$	$V_{DDQ} + 0.5$	V	4,5
Input Low Voltage	$V_{IL2}$	-0.5	0.2	V	4,5

### Notes:

1.  $V_{IH(MAX)}$  and  $V_{IL(MIN)}$  apply for pulse widths less than one-quarter of the cycle time.
2. Input rise and fall times must be a minimum of 1 V/ns, and within 10% of each other.
3. Parameters apply to  $\overline{K}$ ,  $\overline{K}$ , SA, D,  $\overline{R}$ ,  $\overline{W}$ ,  $\overline{BW}$  during normal operation and JTAG boundary scan testing.
4. Parameters apply to Doff, ODT during normal operation and JTAG boundary scan testing.
5. Parameters apply to ZQ during JTAG boundary scan testing only.

## Capacitance

( $T_A = 25^\circ\text{C}$ ,  $f = 1\text{ MHz}$ ,  $V_{DD} = 1.8\text{ V}$ )

Parameter	Symbol	Test conditions	Typ.	Max.	Unit
Input Capacitance	$C_{IN}$	$V_{IN} = 0\text{ V}$	4	5	pF
Output Capacitance	$C_{OUT}$	$V_{OUT} = 0\text{ V}$	6	7	pF
Clock Capacitance	$C_{CLK}$	$V_{IN} = 0\text{ V}$	5	6	pF

**Note:**

This parameter is sample tested.

## AC Test Conditions

Parameter	Conditions
Input high level	1.25
Input low level	0.25 V
Max. input slew rate	2 V/ns
Input reference level	0.75
Output reference level	$V_{DDQ}/2$

**Note:**

Test conditions as specified with output loading as shown unless otherwise noted.

## AC Test Load Diagram

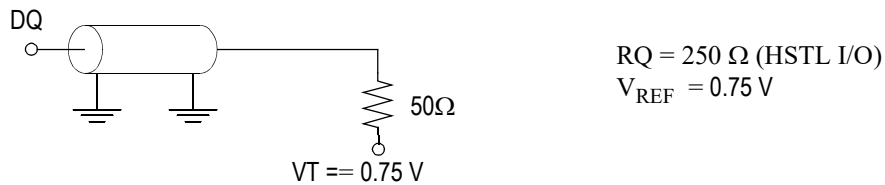

## Input and Output Leakage Characteristics

Parameter	Symbol	Test Conditions	Min.	Max
Input Leakage Current (except mode pins)	$I_{IL}$	$V_{IN} = 0\text{ to }V_{DD}$	-2 $\mu\text{A}$	2 $\mu\text{A}$
$\overline{\text{Doff}}$	$I_{IL\overline{\text{DOFF}}}$	$V_{IN} = 0\text{ to }V_{DD}$	-2 $\mu\text{A}$	100 $\mu\text{A}$
ODT	$I_{IL\text{ODT}}$	$V_{IN} = 0\text{ to }V_{DD}$	-100 $\mu\text{A}$	2 $\mu\text{A}$
Output Leakage Current	$I_{OL}$	Output Disable, $V_{OUT} = 0\text{ to }V_{DDQ}$	-2 $\mu\text{A}$	2 $\mu\text{A}$

### Programmable Impedance HSTL Output Driver DC Electrical Characteristics

Parameter	Symbol	Min.	Max.	Units	Notes
Output High Voltage	$V_{OH1}$	$V_{DDQ}/2 - 0.15$	$V_{DDQ}/2 + 0.15$	V	1, 3
Output Low Voltage	$V_{OL1}$	$V_{DDQ}/2 - 0.15$	$V_{DDQ}/2 + 0.15$	V	2, 3
Output High Voltage	$V_{OH2}$	$V_{DDQ} - 0.2$	$V_{DDQ}$	V	4, 5
Output Low Voltage	$V_{OL2}$	$V_{SS}$	0.2	V	4, 6

#### Notes:

- $I_{OH} = (V_{DDQ}/2) / (RQ/5) \pm 20\%$  @  $V_{OH} = V_{DDQ}/2$  (for:  $175\Omega \leq RQ \leq 350\Omega$ ).
- $I_{OL} = (V_{DDQ}/2) / (RQ/5) \pm 20\%$  @  $V_{OL} = V_{DDQ}/2$  (for:  $175\Omega \leq RQ \leq 350\Omega$ ).
- Parameter tested with  $RQ = 250\Omega$  and  $V_{DDQ} = 1.5$  V
- $0\Omega \leq RQ \leq \infty\Omega$
- $I_{OH} = -1.0$  mA
- $I_{OL} = 1.0$  mA

### Operating Currents

Parameter	Symbol	Test Conditions	-350M	-250M	Unit	Notes
			-55 to 125°C	-55 to 125°C		
Operating Current (x36): DDR	$I_{DD}$	$V_{DD} = \text{Max}$ , $I_{OUT} = 0$ mA Cycle Time $\geq t_{KHKH}$ Min	1000	900	mA	2, 3
Operating Current (x18): DDR	$I_{DD}$	$V_{DD} = \text{Max}$ , $I_{OUT} = 0$ mA Cycle Time $\geq t_{KHKH}$ Min	950	850	mA	2, 3
Standby Current (NOP): DDR	$I_{SB1}$	Device deselected, $I_{OUT} = 0$ mA, $f = \text{Max}$ , All Inputs $\leq 0.2$ V or $\geq V_{DD} - 0.2$ V	590	520	mA	2, 4

#### Notes:

- Power measured with output pins floating.
- Minimum cycle,  $I_{OUT} = 0$  mA
- Operating current is calculated with 50% read cycles and 50% write cycles.
- Standby Current is only after all pending read and write burst operations are completed.

**AC Electrical Characteristics (@DLL = 1)**

Parameter	Symbol	-350M		-250M		Units	Notes
		Min	Max	Min	Max		
<b>Clock</b>							
K, $\bar{K}$ Clock Cycle Time	$t_{KHKH}$	2.86	8.4	4.0	8.4	ns	
tK Variable	$t_{KVar}$	—	0.2	—	0.2	ns	4
K, $\bar{K}$ Clock High Pulse Width	$t_{KHKL}$	0.4	—	0.4	—	cycle	
K, $\bar{K}$ Clock Low Pulse Width	$t_{KLKH}$	0.4	—	0.4	—	cycle	
K to $\bar{K}$ High	$t_{KH\bar{K}H}$	1.22	—	1.8	—	ns	
$\bar{K}$ to K High	$t_{\bar{K}HKH}$	1.22	—	1.8	—	ns	
DLL Lock Time	$t_{KLock}$	2048	—	2048	—	cycle	5
K Static to DLL reset	$t_{KReset}$	30	—	30	—	ns	
K, $\bar{K}$ Clock Initialization	$t_{KInit}$	20	—	20	—	$\mu$ s	6
<b>Output Times</b>							
K, $\bar{K}$ Clock High to Data Output Valid	$t_{KHQV}$	—	0.65	—	0.65	ns	
K, $\bar{K}$ Clock High to Data Output Hold	$t_{KHQX}$	-0.65	—	-0.65	—	ns	
K, $\bar{K}$ Clock High to Echo Clock Valid	$t_{KHCQV}$	—	0.65	—	0.65	ns	
K, $\bar{K}$ Clock High to Echo Clock Hold	$t_{KHCQX}$	-0.65	—	-0.65	—	ns	
CQ, $\bar{CQ}$ High Output Valid	$t_{CQHQV}$	—	0.35	—	0.40	ns	
CQ, $\bar{CQ}$ High Output Hold	$t_{CQHQX}$	-0.35	—	-0.40	—	ns	
CQ, $\bar{CQ}$ High to QVLD	$t_{QVLD}$	-0.35	0.35	-0.40	0.40	ns	
CQ Phase Distortion	$t_{CQH\bar{C}QH}$ $t_{\bar{C}QH\bar{C}QH}$	1.19	—	1.67	—	ns	
K Clock High to Data Output High-Z	$t_{KHQZ}$	—	0.65	—	0.65	ns	
K Clock High to Data Output Low-Z	$t_{KHQX1}$	-0.65	—	-0.65	—	ns	
<b>Setup Times</b>							
Address Input Setup Time	$t_{AVKH}$	0.3	—	0.35	—	ns	1
Control Input Setup Time ( $\bar{R}$ , $\bar{W}$ )	$t_{VVKH}$	0.3	—	0.35	—	ns	2
Control Input Setup Time ( $\overline{BW\bar{X}}$ ) ( $\overline{BW\bar{X}}$ )	$t_{VVKH}$	0.3	—	0.35	—	ns	3
Data Input Setup Time	$t_{DVKH}$	0.3	—	0.35	—	ns	
<b>Hold Times</b>							
Address Input Hold Time	$t_{KHAX}$	0.3	—	0.35	—	ns	1
Control Input Hold Time ( $\bar{R}$ , $\bar{W}$ )	$t_{KHIX}$	0.3	—	0.35	—	ns	2
Control Input Hold Time ( $\overline{BW\bar{X}}$ ) ( $\overline{BW\bar{X}}$ )	$t_{KHIX}$	0.3	—	0.35	—	ns	3
Data Input Hold Time	$t_{KHDX}$	0.3	—	0.35	—	ns	

**Notes:**

- All Address inputs must meet the specified setup and hold times for all latching clock edges.
- Control signals are  $\bar{R}$ ,  $\bar{W}$
- Control signals are  $\overline{BW0}$ ,  $\overline{BW1}$ , and  $\overline{NW0}$ ,  $\overline{NW1}$  for x8) and ( $\overline{BW2}$ ,  $\overline{BW3}$  for x36).
- Clock phase jitter is the variance from clock rising edge to the next expected clock rising edge.
- $V_{DD}$  slew rate must be less than 0.1 V DC per 50 ns for DLL lock retention. DLL lock time begins once  $V_{DD}$  and input clock are stable.
- After device power-up, 20 $\mu$ s of stable input clocks (as specified by  $t_{KInit}$ ) must be supplied before reads and writes are issued.

**AC Electrical Characteristics (@DLL = 0)**

Parameter	Symbol	-350M		-250M		Units	Notes
		Min	Max	Min	Max		
<b>Clock</b>							
K, $\bar{K}$ Clock Cycle Time	$t_{KHKH}$	2.86	—	4.0	—	ns	
tK Variable	$t_{KVar}$	—	0.2	—	0.2	ns	4
K, $\bar{K}$ Clock High Pulse Width	$t_{KHKL}$	0.4	—	0.4	—	cycle	
K, $\bar{K}$ Clock Low Pulse Width	$t_{KLKH}$	0.4	—	0.4	—	cycle	
K to $\bar{K}$ High	$t_{KH\bar{K}H}$	1.22	—	1.8	—	ns	
$\bar{K}$ to K High	$t_{\bar{K}HKH}$	1.22	—	1.8	—	ns	
K, $\bar{K}$ Clock Initialization	$t_{KInit}$	20	—	20	—	$\mu$ s	5
<b>Output Times</b>							
K, $\bar{K}$ Clock High to Data Output Valid	$t_{KHQV}$	—	3.5	—	3.5	ns	
K, $\bar{K}$ Clock High to Data Output Hold	$t_{KHQX}$	1.0	—	1.0	—	ns	
K, $\bar{K}$ Clock High to Echo Clock Valid	$t_{KHQCV}$	—	3.5	—	3.5	ns	
K, $\bar{K}$ Clock High to Echo Clock Hold	$t_{KHQCX}$	1.0	—	1.0	—	ns	
CQ, $\bar{CQ}$ High Output Valid	$t_{CQHCV}$	—	0.35	—	0.40	ns	
CQ, $\bar{CQ}$ High Output Hold	$t_{CQHCV}$	-0.35	—	-0.40	—	ns	
CQ Phase Distortion	$t_{CQH\bar{C}QH}$ $t_{\bar{C}QHCV}$	1.19	—	1.67	—	ns	
K Clock High to Data Output High-Z	$t_{KHQZ}$	—	3.5	—	3.5	ns	
K Clock High to Data Output Low-Z	$t_{KHQX1}$	1.0	—	1.0	—	ns	
<b>Setup Times</b>							
Address Input Setup Time	$t_{AVKH}$	0.3	—	0.35	—	ns	1
Control Input Setup Time ( $\bar{R}$ , $\bar{W}$ )	$t_{IVKH}$	0.3	—	0.35	—	ns	2
Control Input Setup Time ( $\overline{BW\bar{X}}$ ) ( $\overline{BW\bar{X}}$ )	$t_{IVKH}$	0.3	—	0.35	—	ns	3
Data Input Setup Time	$t_{DVKH}$	0.3	—	0.35	—	ns	
<b>Hold Times</b>							
Address Input Hold Time	$t_{KHAX}$	0.3	—	0.35	—	ns	1
Control Input Hold Time ( $\bar{R}$ , $\bar{W}$ )	$t_{KHIX}$	0.3	—	0.35	—	ns	2
Control Input Hold Time ( $\overline{BW\bar{X}}$ ) ( $\overline{BW\bar{X}}$ )	$t_{KHIX}$	0.3	—	0.35	—	ns	3
Data Input Hold Time	$t_{KHDX}$	0.3	—	0.35	—	ns	

**Notes:**

1. All Address inputs must meet the specified setup and hold times for all latching clock edges.
2. Control signals are  $\bar{R}$ ,  $\bar{W}$
3. Control signals are  $\overline{BW0}$ ,  $\overline{BW1}$ , and  $\overline{NW0}$ ,  $\overline{NW1}$  for x8) and  $\overline{BW2}$ ,  $\overline{BW3}$  for x36).
4. Clock phase jitter is the variance from clock rising edge to the next expected clock rising edge.
5. After device power-up, 20 $\mu$ s of stable input clocks (as specified by  $t_{KInit}$ ) must be supplied before reads and writes are issued.



Read NOP CQ-Based Timing Diagram (DLL = 1)

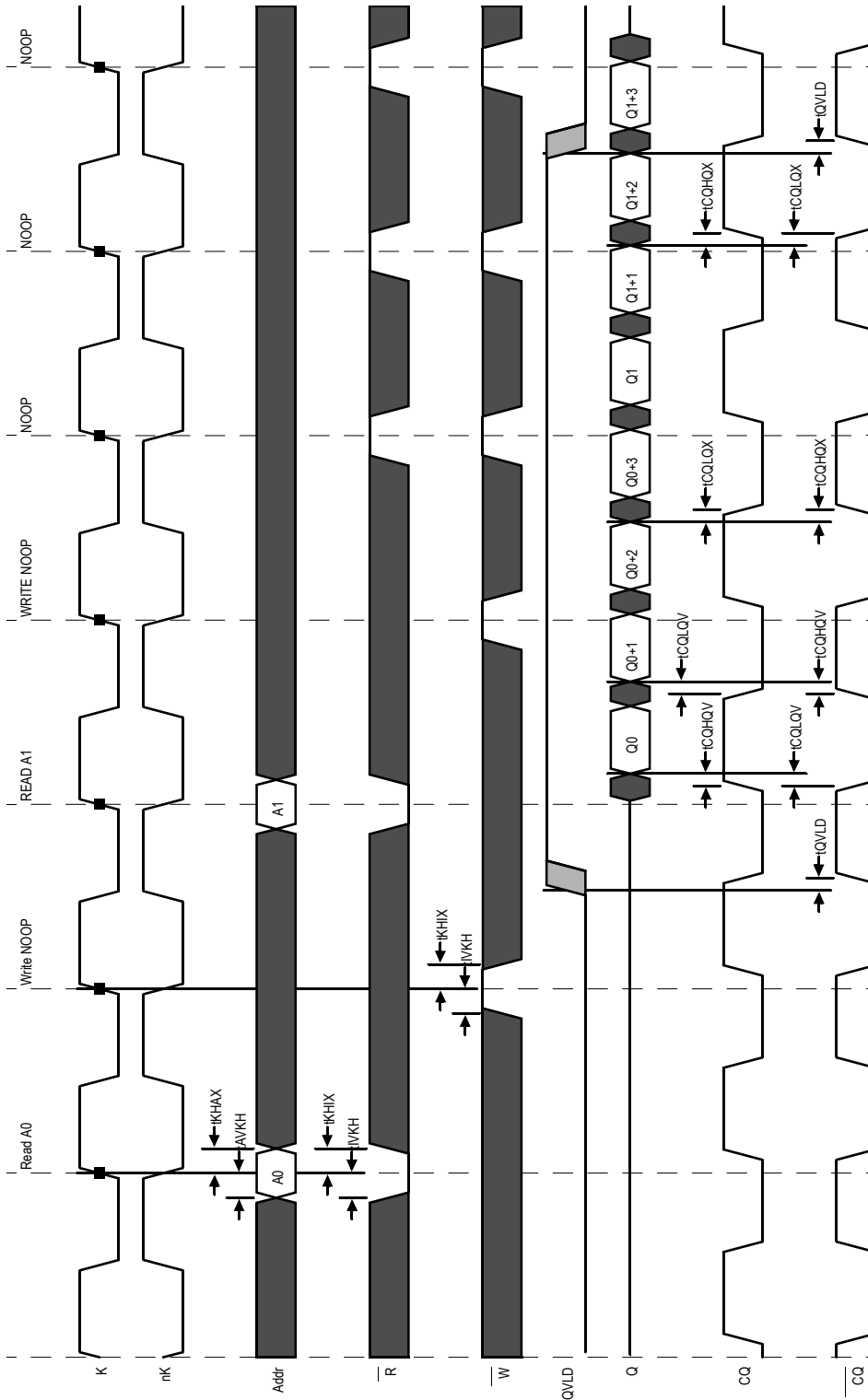

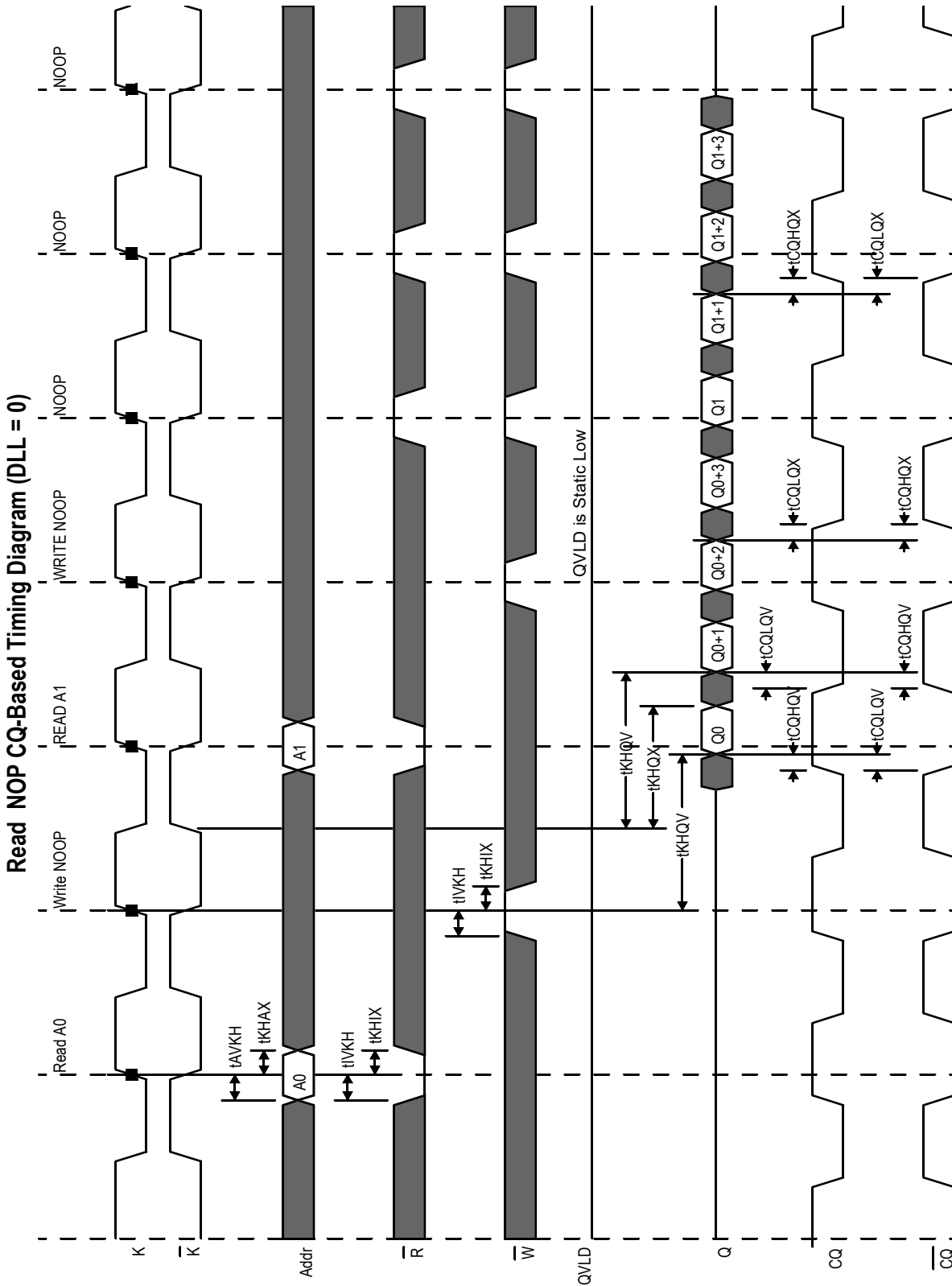

Read-Write CQ-Based Timing Diagram (DLL = 1)

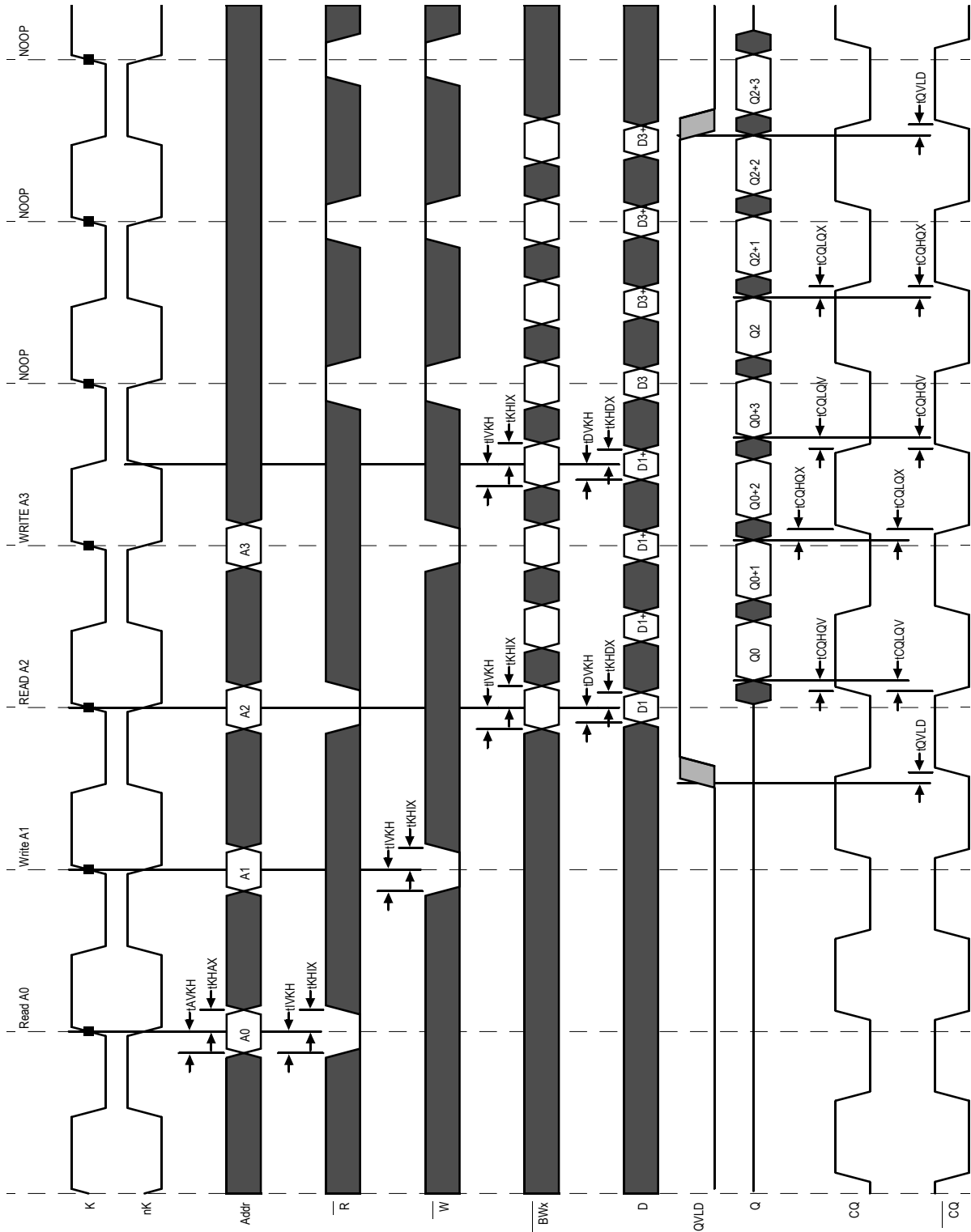

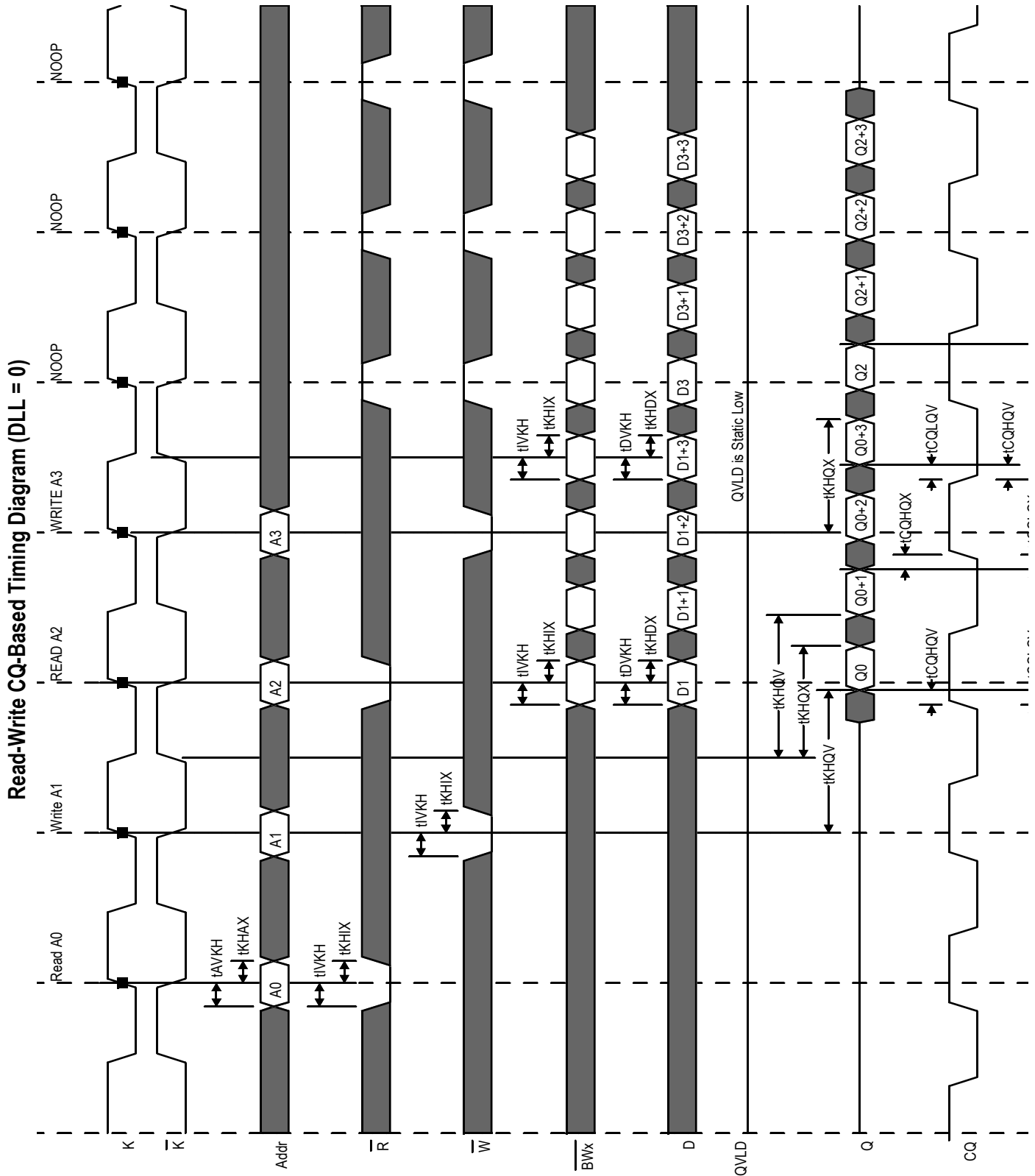

**Write NOP Timing Diagram**

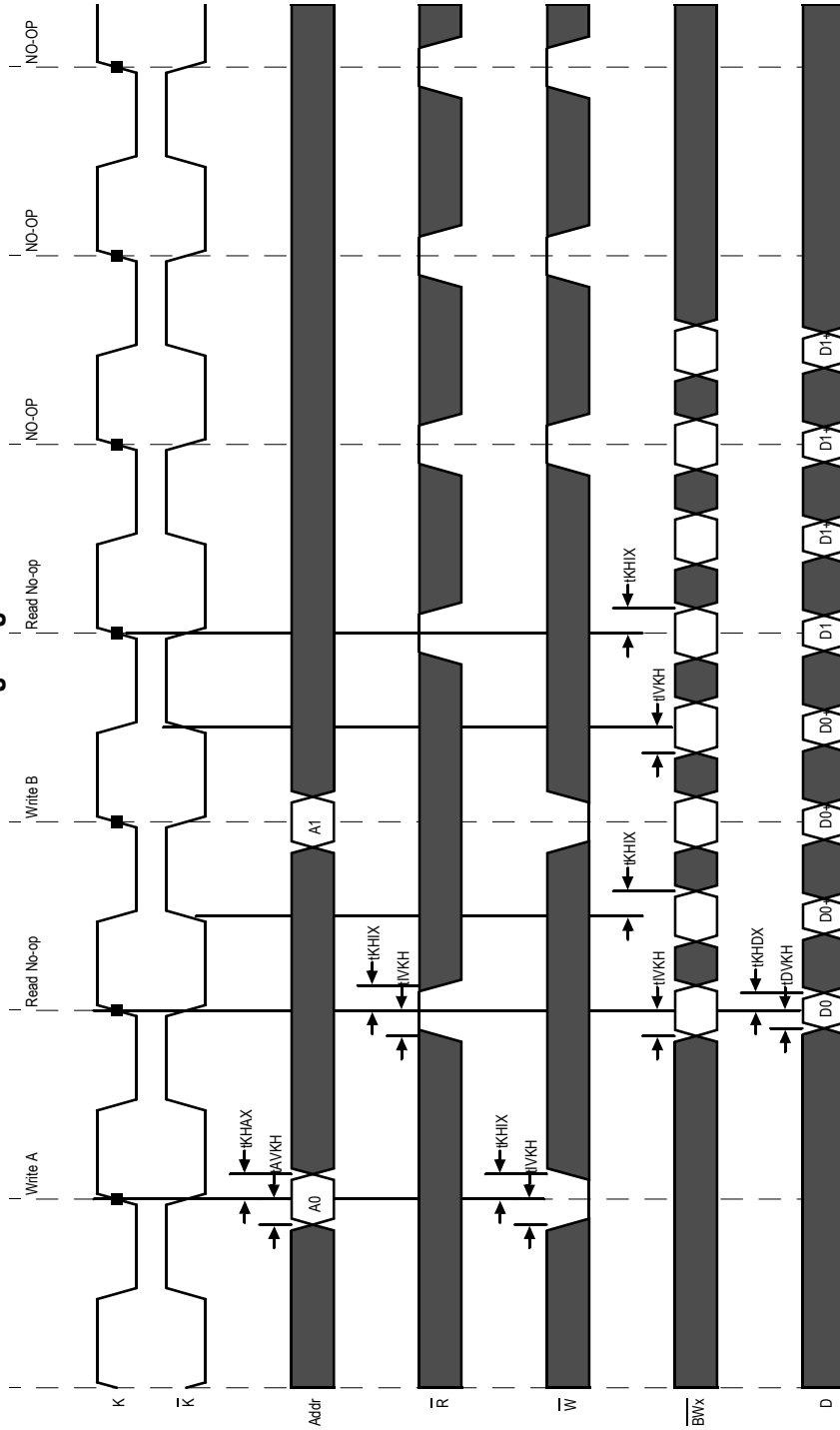

## JTAG Port Operation

### Overview

The JTAG Port on this RAM operates in a manner that is compliant with IEEE Standard 1149.1-1990, a serial boundary scan interface standard (commonly referred to as JTAG). The JTAG Port input interface levels scale with  $V_{DD}$ . The JTAG output drivers are powered by  $V_{DD}$ .

### Disabling the JTAG Port

It is possible to use this device without utilizing the JTAG port. The port is reset at power-up and will remain inactive unless clocked. TCK, TDI, and TMS are designed with internal pull-up circuits. To assure normal operation of the RAM with the JTAG Port unused, TCK, TDI, and TMS may be left floating or tied to either  $V_{DD}$  or  $V_{SS}$ . TDO should be left unconnected.

## JTAG Pin Descriptions

Pin	Pin Name	I/O	Description
TCK	Test Clock	In	Clocks all TAP events. All inputs are captured on the rising edge of TCK and all outputs propagate from the falling edge of TCK.
TMS	Test Mode Select	In	The TMS input is sampled on the rising edge of TCK. This is the command input for the TAP controller state machine. An undriven TMS input will produce the same result as a logic one input level.
TDI	Test Data In	In	The TDI input is sampled on the rising edge of TCK. This is the input side of the serial registers placed between TDI and TDO. The register placed between TDI and TDO is determined by the state of the TAP Controller state machine and the instruction that is currently loaded in the TAP Instruction Register (refer to the TAP Controller State Diagram). An undriven TDI pin will produce the same result as a logic one input level.
TDO	Test Data Out	Out	Output that is active depending on the state of the TAP state machine. Output changes in response to the falling edge of TCK. This is the output side of the serial registers placed between TDI and TDO.

### Note:

This device does not have a TRST (TAP Reset) pin. TRST is optional in IEEE 1149.1. The Test-Logic-Reset state is entered while TMS is held high for five rising edges of TCK. The TAP Controller is also reset automatically at power-up.

## JTAG Port Registers

### Overview

The various JTAG registers, referred to as Test Access Port or TAP Registers, are selected (one at a time) via the sequences of 1s and 0s applied to TMS as TCK is strobed. Each of the TAP Registers is a serial shift register that captures serial input data on the rising edge of TCK and pushes serial data out on the next falling edge of TCK. When a register is selected, it is placed between the TDI and TDO pins.

### Instruction Register

The Instruction Register holds the instructions that are executed by the TAP controller when it is moved into the Run, Test/Idle, or the various data register states. Instructions are 3 bits long. The Instruction Register can be loaded when it is placed between the TDI and TDO pins. The Instruction Register is automatically preloaded with the IDCODE instruction at power-up or whenever the controller is placed in Test-Logic-Reset state.

### Bypass Register

The Bypass Register is a single bit register that can be placed between TDI and TDO. It allows serial test data to be passed through the RAM's JTAG Port to another device in the scan chain with as little delay as possible.

### Boundary Scan Register

The Boundary Scan Register is a collection of flip flops that can be preset by the logic level found on the RAM's input or I/O pins. The flip flops are then daisy chained together so the levels found can be shifted serially out of the JTAG Port's TDO pin. The Boundary Scan Register also includes a number of place holder flip flops (always set to a logic 1). The relationship between the device pins and the bits in the Boundary Scan Register is described in the Scan Order Table following. The Boundary Scan

Register, under the control of the TAP Controller, is loaded with the contents of the RAMs I/O ring when the controller is in Capture-DR state and then is placed between the TDI and TDO pins when the controller is moved to Shift-DR state. SAMPLE-Z, SAMPLE/PRELOAD and EXTEST instructions can be used to activate the Boundary Scan Register.

### JTAG TAP Block Diagram

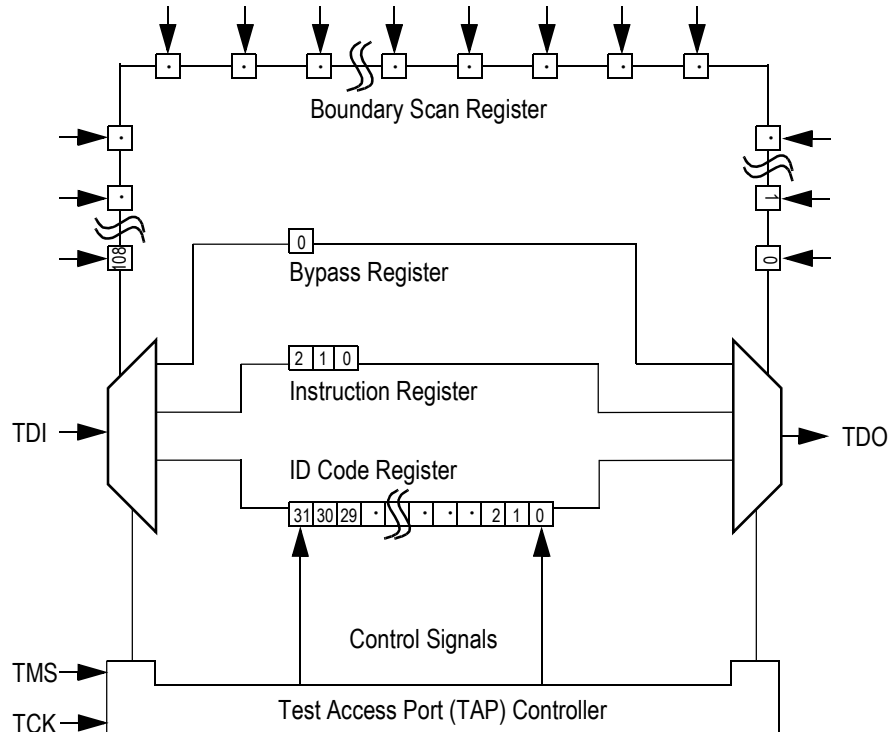

#### Identification (ID) Register

The ID Register is a 32-bit register that is loaded with a device and vendor specific 32-bit code when the controller is put in Capture-DR state with the IDCODE command loaded in the Instruction Register. The code is loaded from a 32-bit on-chip ROM. It describes various attributes of the RAM as indicated below. The register is then placed between the TDI and TDO pins when the controller is moved into Shift-DR state. Bit 0 in the register is the LSB and the first to reach TDO when shifting begins.

#### ID Register Contents

See BSDL Model																GSI Technology JEDEC Vendor ID Code						Presence Register										
Bit #	31	30	29	28	27	26	25	24	23	22	21	20	19	18	17	16	15	14	13	12	11	10	9	8	7	6	5	4	3	2	1	0
	X	X	X	X	X	X	X	X	X	X	X	X	X	X	X	X	X	X	X	X	0	0	0	1	1	0	1	1	0	0	1	1

## Tap Controller Instruction Set

### Overview

There are two classes of instructions defined in the Standard 1149.1-1990; the standard (Public) instructions, and device specific (Private) instructions. Some Public instructions are mandatory for 1149.1 compliance. Optional Public instructions must be implemented in prescribed ways. The TAP on this device may be used to monitor all input and I/O pads, and can be used to load address, data or control signals into the RAM or to preload the I/O buffers.

When the TAP controller is placed in Capture-IR state the two least significant bits of the instruction register are loaded with 01. When the controller is moved to the Shift-IR state the Instruction Register is placed between TDI and TDO. In this state the desired instruction is serially loaded through the TDI input (while the previous contents are shifted out at TDO). For all instructions, the TAP executes newly loaded instructions only when the controller is moved to Update-IR state. The TAP instruction set for this device is listed in the following table.

**JTAG Tap Controller State Diagram**

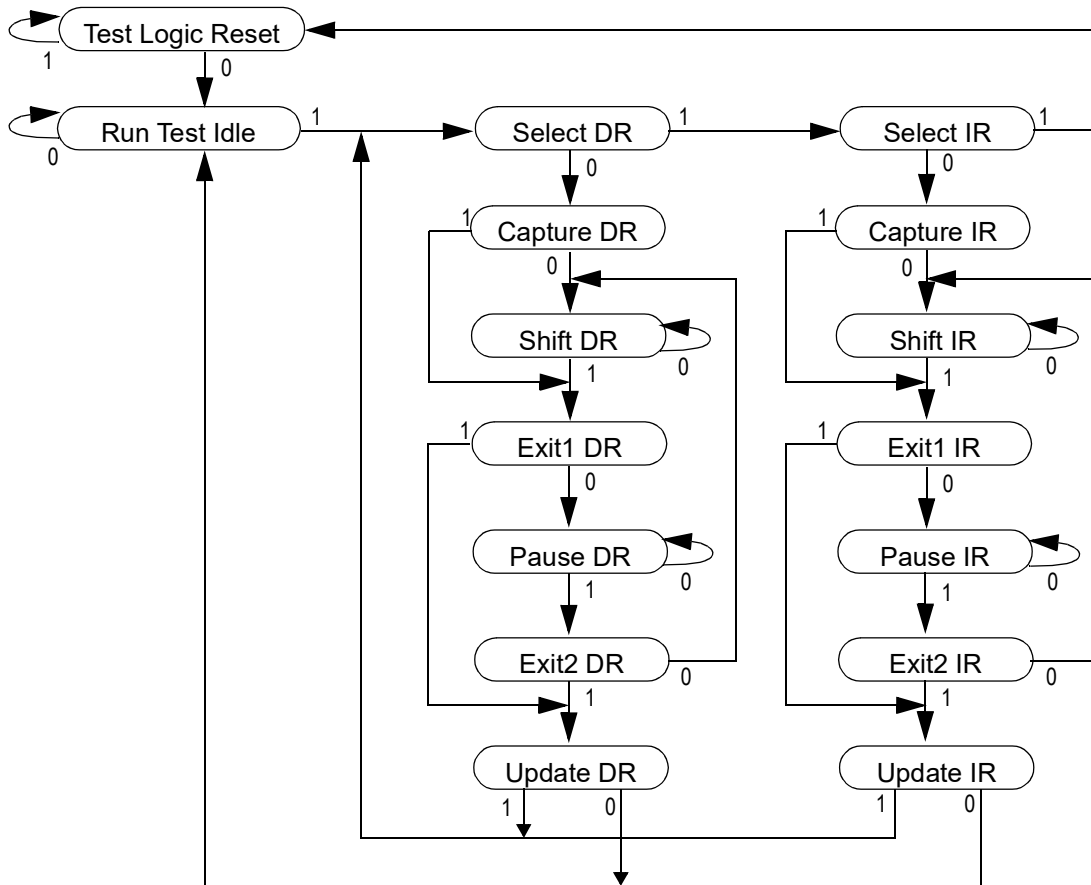

### Instruction Descriptions

#### BYPASS

When the BYPASS instruction is loaded in the Instruction Register the Bypass Register is placed between TDI and TDO. This occurs when the TAP controller is moved to the Shift-DR state. This allows the board level scan path to be shortened to facilitate testing of other devices in the scan path.

#### SAMPLE/PRELOAD

SAMPLE/PRELOAD is a Standard 1149.1 mandatory public instruction. When the SAMPLE / PRELOAD instruction is



loaded in the Instruction Register, moving the TAP controller into the Capture-DR state loads the data in the RAMs input and I/O buffers into the Boundary Scan Register. Boundary Scan Register locations are not associated with an input or I/O pin, and are loaded with the default state identified in the Boundary Scan Chain table at the end of this section of the datasheet. Because the RAM clock is independent from the TAP Clock (TCK) it is possible for the TAP to attempt to capture the I/O ring contents while the input buffers are in transition (i.e. in a metastable state). Although allowing the TAP to sample metastable inputs will not harm the device, repeatable results cannot be expected. RAM input signals must be stabilized for long enough to meet the TAPs input data capture set-up plus hold time ( $t_{TS}$  plus  $t_{TH}$ ). The RAMs clock inputs need not be paused for any other TAP operation except capturing the I/O ring contents into the Boundary Scan Register. Moving the controller to Shift-DR state then places the boundary scan register between the TDI and TDO pins.

## EXTEST

EXTEST is an IEEE 1149.1 mandatory public instruction. It is to be executed whenever the instruction register is loaded with all logic 0s. The EXTEST command does not block or override the RAM's input pins; therefore, the RAM's internal state is still determined by its input pins.

Typically, the Boundary Scan Register is loaded with the desired pattern of data with the SAMPLE/PRELOAD command. Then the EXTEST command is used to output the Boundary Scan Register's contents, in parallel, on the RAM's data output drivers on the falling edge of TCK when the controller is in the Update-IR state.

Alternately, the Boundary Scan Register may be loaded in parallel using the EXTEST command. When the EXTEST instruction is selected, the state of all the RAM's input and I/O pins, as well as the default values at Scan Register locations not associated with a pin, are transferred in parallel into the Boundary Scan Register on the rising edge of TCK in the Capture-DR state, the RAM's output pins drive out the value of the Boundary Scan Register location with which each output pin is associated.

## IDCODE

The IDCODE instruction causes the ID ROM to be loaded into the ID register when the controller is in Capture-DR mode and places the ID register between the TDI and TDO pins in Shift-DR mode. The IDCODE instruction is the default instruction loaded in at power up and any time the controller is placed in the Test-Logic-Reset state.

## SAMPLE-Z

If the SAMPLE-Z instruction is loaded in the instruction register, all RAM outputs are forced to an inactive drive state (high-Z) and the Boundary Scan Register is connected between TDI and TDO when the TAP controller is moved to the Shift-DR state.

## JTAG TAP Instruction Set Summary

Instruction	Code	Description	Notes
EXTEST	000	Places the Boundary Scan Register between TDI and TDO.	1
IDCODE	001	Preloads ID Register and places it between TDI and TDO.	1, 2
SAMPLE-Z	010	Captures I/O ring contents. Places the Boundary Scan Register between TDI and TDO. Forces all RAM output drivers to High-Z.	1
GSI	011	GSI private instruction.	1
SAMPLE/PRELOAD	100	Captures I/O ring contents. Places the Boundary Scan Register between TDI and TDO.	1
GSI	101	GSI private instruction.	1
GSI	110	GSI private instruction.	1
BYPASS	111	Places Bypass Register between TDI and TDO.	1

### Notes:

1. Instruction codes expressed in binary, MSB on left, LSB on right.
2. Default instruction automatically loaded at power-up and in test-logic-reset state.

## JTAG Port Recommended Operating Conditions and DC Characteristics

Parameter	Symbol	Min.	Max.	Unit	Notes
Test Port Input Low Voltage	$V_{ILJ}$	-0.3	$0.3 * V_{DD}$	V	1
Test Port Input High Voltage	$V_{IHJ}$	$0.7 * V_{DD}$	$V_{DD} + 0.3$	V	1
TMS, TCK and TDI Input Leakage Current	$I_{INHJ}$	-300	1	uA	2
TMS, TCK and TDI Input Leakage Current	$I_{INLJ}$	-1	100	uA	3
TDO Output Leakage Current	$I_{OLJ}$	-1	1	uA	4
Test Port Output High Voltage	$V_{OHJ}$	$V_{DD} - 0.2$	—	V	5, 6
Test Port Output Low Voltage	$V_{OLJ}$	—	0.2	V	5, 7
Test Port Output CMOS High	$V_{OHJC}$	$V_{DD} - 0.1$	—	V	5, 8
Test Port Output CMOS Low	$V_{OLJC}$	—	0.1	V	5, 9

### Notes:

- Input Under/overshoot voltage must be  $-1\text{ V} < V_i < V_{DDn} + 1\text{ V}$  not to exceed 2.9 V maximum, with a pulse width not to exceed 20% tTKC.
- $V_{ILJ} \leq V_{IN} \leq V_{DDn}$
- $0\text{ V} \leq V_{IN} \leq V_{ILJn}$
- Output Disable,  $V_{OUT} = 0$  to  $V_{DDn}$
- The TDO output driver is served by the  $V_{DD}$  supply.
- $I_{OHJ} = -2\text{ mA}$
- $I_{OLJ} = +2\text{ mA}$
- $I_{OHJC} = -100\text{ uA}$
- $I_{OLJC} = +100\text{ uA}$

## JTAG Port AC Test Conditions

Parameter	Conditions
Input high level	$V_{DD} - 0.2\text{ V}$
Input low level	0.2 V
Input slew rate	1 V/ns
Input reference level	$V_{DD}/2$
Output reference level	$V_{DD}/2$

### Notes:

- Include scope and jig capacitance.
- Test conditions as shown unless otherwise noted.

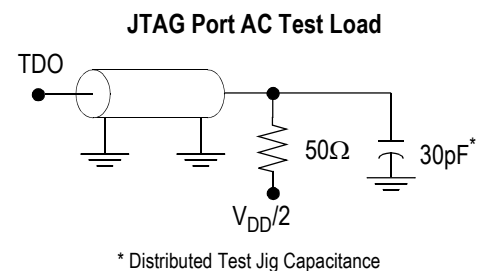

### JTAG Port Timing Diagram

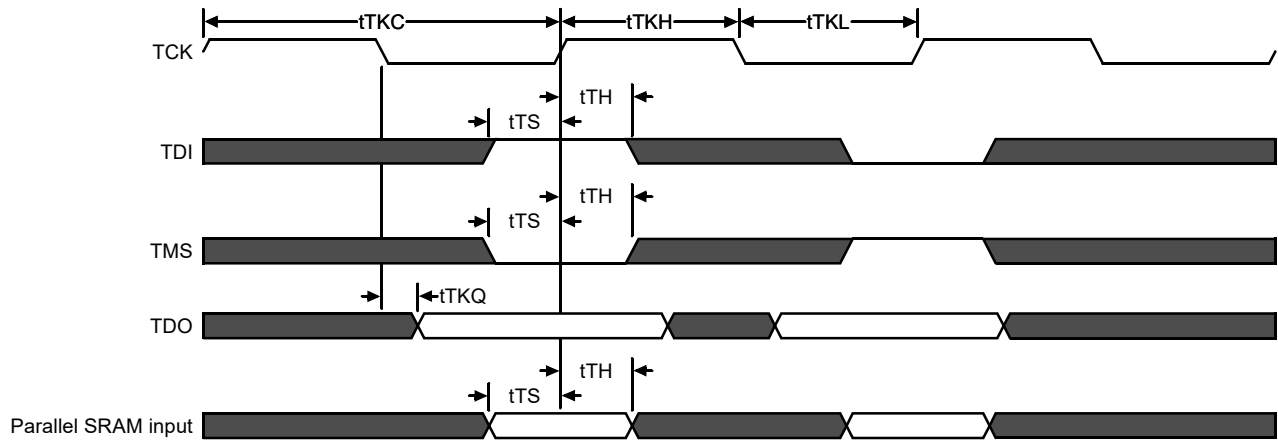

### JTAG Port AC Electrical Characteristics

Parameter	Symbol	Min	Max	Unit
TCK Cycle Time	$t_{TKC}$	50	—	ns
TCK Low to TDO Valid	$t_{TKQ}$	—	20	ns
TCK High Pulse Width	$t_{TKH}$	20	—	ns
TCK Low Pulse Width	$t_{TKL}$	20	—	ns
TDI & TMS Set Up Time	$t_{TS}$	10	—	ns
TDI & TMS Hold Time	$t_{TH}$	10	—	ns

Package Dimensions—165-Bump CCGA (Package CE)

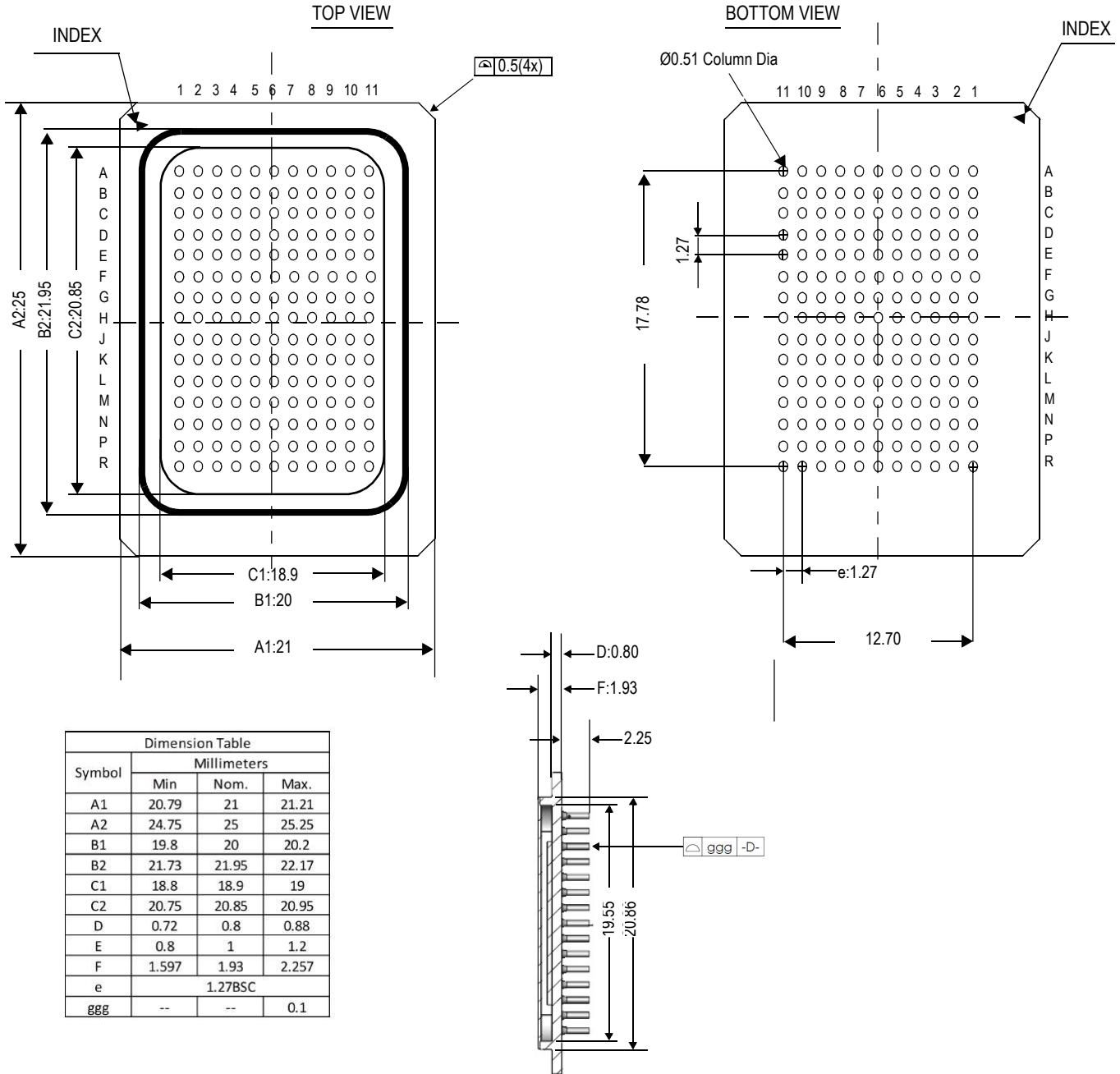

Package Dimensions—165-Bump LGA (Package LE)

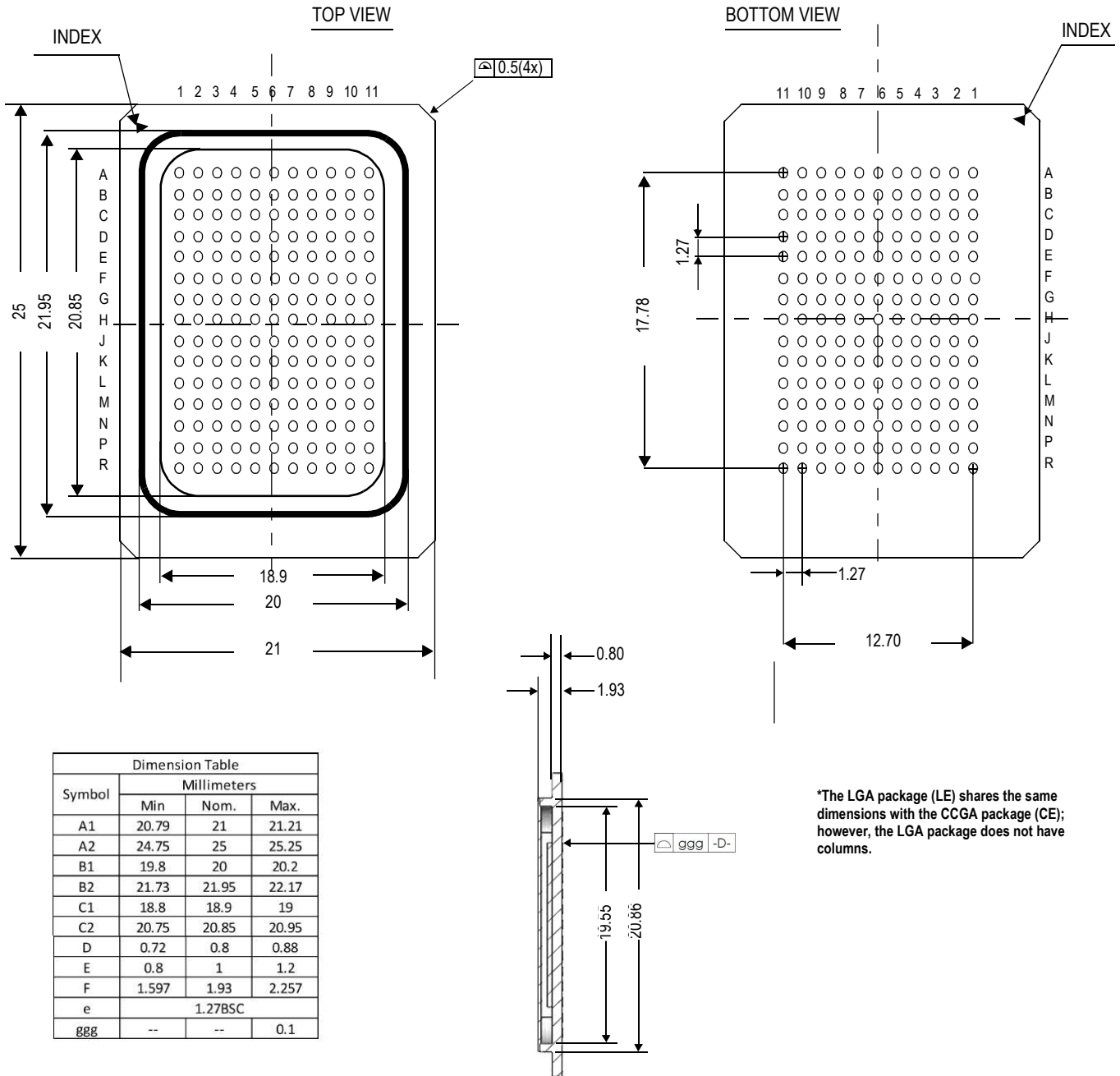

\*The LGA package (LE) shares the same dimensions with the CCGA package (CE); however, the LGA package does not have columns.

### Product Nomenclature Example

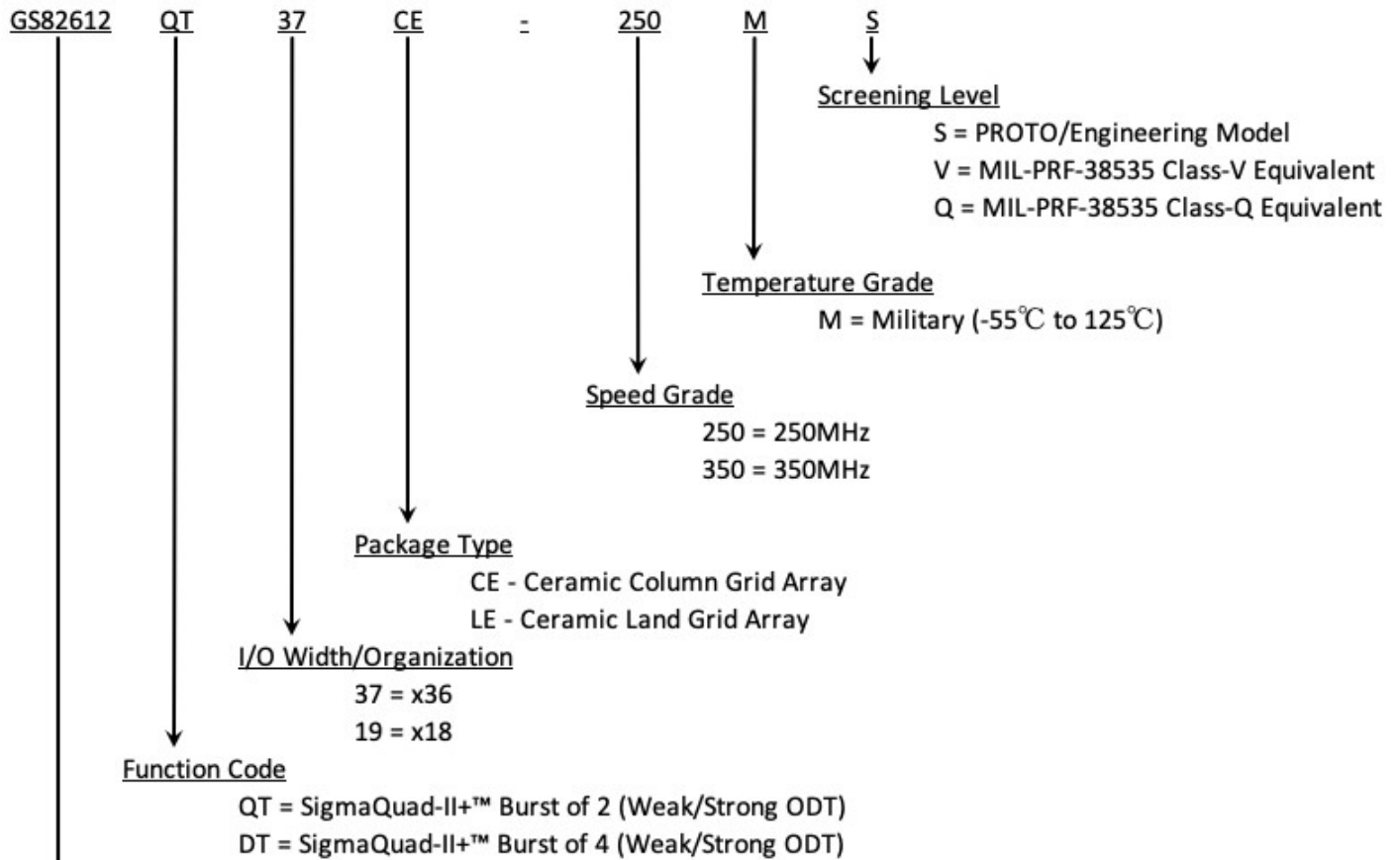

### GSI Product Line Code & Density

GS82612 = RadHard 288Mb SigmaQuad-II+ SRAM

GS81332 = RadHard 144Mb SigmaQuad-II+ SRAM

GS8692 = RadHard 72Mb SigmaQuad-II+ SRAM

### Ordering Information—GSI SigmaQuad-II+ SRAM

Org	Part Number	Type	Package	Speed (MHz)	T <sub>J</sub> <sup>*</sup>
<b>288Mb</b>					
8M x 36	GS82612DT37CE-350MS	288Mb SigmaQuad-II+ B4 SRAM	165-bump CCGA (Engineering Sample)	350	M
8M x 36	GS82612DT37CE-250MS	288Mb SigmaQuad-II+ B4 SRAM	165-bump CCGA (Engineering Sample)	250	M
16M x 18	GS82612DT19CE-350MS	288Mb SigmaQuad-II+ B4 SRAM	165-bump CCGA (Engineering Sample)	350	M
16M x 18	GS82612DT19CE-250MS	288Mb SigmaQuad-II+ B4 SRAM	165-bump CCGA (Engineering Sample)	250	M
8M x 36	GS82612DT37LE-350MS	288Mb SigmaQuad-II+ B4 SRAM	165-bump LGA (Engineering Sample)	350	M
8M x 36	GS82612DT37LE-250MS	288Mb SigmaQuad-II+ B4 SRAM	165-bump LGA (Engineering Sample)	250	M
16M x 18	GS82612DT19LE-350MS	288Mb SigmaQuad-II+ B4 SRAM	165-bump LGA (Engineering Sample)	350	M
16M x 18	GS82612DT19LE-250MS	288Mb SigmaQuad-II+ B4 SRAM	165-bump LGA (Engineering Sample)	250	M
8M x 36	GS82612DT37CE-350MQ	288Mb SigmaQuad-II+ B4 SRAM	165-bump CCGA (Class-Q)	350	M
8M x 36	GS82612DT37CE-250MQ	288Mb SigmaQuad-II+ B4 SRAM	165-bump CCGA (Class-Q)	250	M
16M x 18	GS82612DT19CE-350MQ	288Mb SigmaQuad-II+ B4 SRAM	165-bump CCGA (Class-Q)	350	M
16M x 18	GS82612DT19CE-250MQ	288Mb SigmaQuad-II+ B4 SRAM	165-bump CCGA (Class-Q)	250	M
8M x 36	GS82612DT37LE-350MQ	288Mb SigmaQuad-II+ B4 SRAM	165-bump LGA (Class-Q)	350	M
8M x 36	GS82612DT37LE-250MQ	288Mb SigmaQuad-II+ B4 SRAM	165-bump LGA (Class-Q)	250	M
16M x 18	GS82612DT19LE-350MQ	288Mb SigmaQuad-II+ B4 SRAM	165-bump LGA (Class-Q)	350	M
16M x 18	GS82612DT19LE-250MQ	288Mb SigmaQuad-II+ B4 SRAM	165-bump LGA (Class-Q)	250	M
8M x 36	GS82612DT37CE-350MV	288Mb SigmaQuad-II+ B4 SRAM	165-bump CCGA (Class-V)	350	M
8M x 36	GS82612DT37CE-250MV	288Mb SigmaQuad-II+ B4 SRAM	165-bump CCGA (Class-V)	250	M
16M x 18	GS82612DT19CE-350MV	288Mb SigmaQuad-II+ B4 SRAM	165-bump CCGA (Class-V)	350	M

**Note:**

M = Military Temperature Range.

**Ordering Information—GSI SigmaQuad-II+ SRAM (Continued)**

Org	Part Number	Type	Package	Speed (MHz)	T <sub>J</sub> <sup>*</sup>
16M x 18	GS82612DT19CE-250MV	288Mb SigmaQuad-II+ B4 SRAM	165-bump CCGA (Class-V)	250	M
8M x 36	GS82612DT37LE-350MV	288Mb SigmaQuad-II+ B4 SRAM	165-bump LGA (Class-V)	350	M
8M x 36	GS82612DT37LE-250MV	288Mb SigmaQuad-II+ B4 SRAM	165-bump LGA (Class-V)	250	M
16M x 18	GS82612DT19LE-350MV	288Mb SigmaQuad-II+ B4 SRAM	165-bump LGA (Class-V)	350	M
16M x 18	GS82612DT19LE-250MV	288Mb SigmaQuad-II+ B4 SRAM	165-bump LGA (Class-V)	250	M
<b>144Mb</b>					
4M x 36	GS81332DT37CE-350MS	144Mb SigmaQuad-II+ B4 SRAM	165-bump CCGA (Engineering Sample)	350	M
4M x 36	GS81332DT37CE-250MS	144Mb SigmaQuad-II+ B4 SRAM	165-bump CCGA (Engineering Sample)	250	M
8M x 18	GS81332DT19CE-350MS	144Mb SigmaQuad-II+ B4 SRAM	165-bump CCGA (Engineering Sample)	350	M
8M x 18	GS81332DT19CE-250MS	144Mb SigmaQuad-II+ B4 SRAM	165-bump CCGA (Engineering Sample)	250	M
4M x 36	GS81332DT37LE-350MS	144Mb SigmaQuad-II+ B4 SRAM	165-bump LGA (Engineering Sample)	350	M
4M x 36	GS81332DT37LE-250MS	144Mb SigmaQuad-II+ B4 SRAM	165-bump LGA (Engineering Sample)	250	M
8M x 18	GS81332DT19LE-350MS	144Mb SigmaQuad-II+ B4 SRAM	165-bump LGA (Engineering Sample)	350	M
8M x 18	GS81332DT19LE-250MS	144Mb SigmaQuad-II+ B4 SRAM	165-bump LGA (Engineering Sample)	250	M
4M x 36	GS81332DT37CE-350MQ	144Mb SigmaQuad-II+ B4 SRAM	165-bump CCGA (Class-Q)	350	M
4M x 36	GS81332DT37CE-250MQ	144Mb SigmaQuad-II+ B4 SRAM	165-bump CCGA (Class-Q)	250	M
8M x 18	GS81332DT19CE-350MQ	144Mb SigmaQuad-II+ B4 SRAM	165-bump CCGA (Class-Q)	350	M
8M x 18	GS81332DT19CE-250MQ	144Mb SigmaQuad-II+ B4 SRAM	165-bump CCGA (Class-Q)	250	M
4M x 36	GS81332DT37LE-350MQ	144Mb SigmaQuad-II+ B4 SRAM	165-bump LGA (Class-Q)	350	M
4M x 36	GS81332DT37LE-250MQ	144Mb SigmaQuad-II+ B4 SRAM	165-bump LGA (Class-Q)	250	M

**Note:**

M = Military Temperature Range.



**Ordering Information—GSI SigmaQuad-II+ SRAM (Continued)**

Org	Part Number	Type	Package	Speed (MHz)	T <sub>J</sub> <sup>*</sup>
8M x 18	GS81332DT19LE-350MQ	144Mb SigmaQuad-II+ B4 SRAM	165-bump LGA (Class-Q)	350	M
8M x 18	GS81332DT19LE-250MQ	144Mb SigmaQuad-II+ B4 SRAM	165-bump LGA (Class-Q)	250	M
4M x 36	GS81332DT37CE-350MV	144Mb SigmaQuad-II+ B4 SRAM	165-bump CCGA (Class-V)	350	M
4M x 36	GS81332DT37CE-250MV	144Mb SigmaQuad-II+ B4 SRAM	165-bump CCGA (Class-V)	250	M
8M x 18	GS81332DT19CE-350MV	144Mb SigmaQuad-II+ B4 SRAM	165-bump CCGA (Class-V)	350	M
8M x 18	GS81332DT19CE-250MV	144Mb SigmaQuad-II+ B4 SRAM	165-bump CCGA (Class-V)	250	M
4M x 36	GS81332DT37LE-350MV	144Mb SigmaQuad-II+ B4 SRAM	165-bump LGA (Class-V)	350	M
4M x 36	GS81332DT37LE-250MV	144Mb SigmaQuad-II+ B4 SRAM	165-bump LGA (Class-V)	250	M
8M x 18	GS81332DT19LE-350MV	144Mb SigmaQuad-II+ B4 SRAM	165-bump LGA (Class-V)	350	M
8M x 18	GS81332DT19LE-250MV	144Mb SigmaQuad-II+ B4 SRAM	165-bump LGA (Class-V)	250	M
<b>72Mb</b>					
2M x 36	GS8692DT37CE-350MS	72Mb SigmaQuad-II+ B4 SRAM	165-bump CCGA (Engineering Sample)	350	M
2M x 36	GS8692DT37CE-250MS	72Mb SigmaQuad-II+ B4 SRAM	165-bump CCGA (Engineering Sample)	250	M
4M x 18	GS8692DT19CE-350MS	72Mb SigmaQuad-II+ B4 SRAM	165-bump CCGA (Engineering Sample)	350	M
4M x 18	GS8692DT19CE-250MS	72Mb SigmaQuad-II+ B4 SRAM	165-bump CCGA (Engineering Sample)	250	M
2M x 36	GS8692DT37LE-350MS	72Mb SigmaQuad-II+ B4 SRAM	165-bump LGA (Engineering Sample)	350	M
2M x 36	GS8692DT37LE-250MS	72Mb SigmaQuad-II+ B4 SRAM	165-bump LGA (Engineering Sample)	250	M
4M x 18	GS8692DT19LE-350MS	72Mb SigmaQuad-II+ B4 SRAM	165-bump LGA (Engineering Sample)	350	M
4M x 18	GS8692DT19LE-250MS	72Mb SigmaQuad-II+ B4 SRAM	165-bump LGA (Engineering Sample)	250	M
2M x 36	GS8692DT37CE-350MQ	72Mb SigmaQuad-II+ B4 SRAM	165-bump CCGA (Class-Q)	350	M

**Note:**

M = Military Temperature Range.

**Ordering Information—GSI SigmaQuad-II+ SRAM (Continued)**

Org	Part Number	Type	Package	Speed (MHz)	T <sub>J</sub> <sup>*</sup>
2M x 36	GS8692DT37CE-250MQ	72Mb SigmaQuad-II+ B4 SRAM	165-bump CCGA (Class-Q)	250	M
4M x 18	GS8692DT19CE-350MQ	72Mb SigmaQuad-II+ B4 SRAM	165-bump CCGA (Class-Q)	350	M
4M x 18	GS8692DT19CE-250MQ	72Mb SigmaQuad-II+ B4 SRAM	165-bump CCGA (Class-Q)	250	M
2M x 36	GS8692DT37LE-350MQ	72Mb SigmaQuad-II+ B4 SRAM	165-bump LGA (Class-Q)	350	M
2M x 36	GS8692DT37LE-250MQ	72Mb SigmaQuad-II+ B4 SRAM	165-bump LGA (Class-Q)	250	M
4M x 18	GS8692DT19LE-350MQ	72Mb SigmaQuad-II+ B4 SRAM	165-bump LGA (Class-Q)	350	M
4M x 18	GS8692DT19LE-250MQ	72Mb SigmaQuad-II+ B4 SRAM	165-bump LGA (Class-Q)	250	M
2M x 36	GS8692DT37CE-350MV	72Mb SigmaQuad-II+ B4 SRAM	165-bump CCGA (Class-V)	350	M
2M x 36	GS8692DT37CE-250MV	72Mb SigmaQuad-II+ B4 SRAM	165-bump CCGA (Class-V)	250	M
4M x 18	GS8692DT19CE-350MV	72Mb SigmaQuad-II+ B4 SRAM	165-bump CCGA (Class-V)	350	M
4M x 18	GS8692DT19CE-250MV	72Mb SigmaQuad-II+ B4 SRAM	165-bump CCGA (Class-V)	250	M
2M x 36	GS8692DT37LE-350MV	72Mb SigmaQuad-II+ B4 SRAM	165-bump LGA (Class-V)	350	M
2M x 36	GS8692DT37LE-250MV	72Mb SigmaQuad-II+ B4 SRAM	165-bump LGA (Class-V)	250	M
4M x 18	GS8692DT19LE-350MV	72Mb SigmaQuad-II+ B4 SRAM	165-bump LGA (Class-V)	350	M
4M x 18	GS8692DT19LE-250MV	72Mb SigmaQuad-II+ B4 SRAM	165-bump LGA (Class-V)	250	M

**Note:**

M = Military Temperature Range.

### SigmaQuad-II+ SRAM Revision History

File Name	Format/Content	Description of changes
2DT1937_r1_RAD		Creation of datasheet
2DT1937_r1_01_RAD	Content	<ul style="list-style-type: none"> <li>• Added DLL on/off option (including new AC Char tables and new bullets on page 1)</li> <li>• Updated package drawings</li> <li>• (Rev1.01a: Added Nomenclature spec and thermal information; Added new process flow diagram)</li> </ul>
2DT1937_r1_02_RAD	Content	<ul style="list-style-type: none"> <li>• Updated power up sequence</li> <li>• Updated process flow</li> <li>• Updated TID spec on page 1</li> <li>• Removed Preliminary banner due to MP status</li> <li>• (Rev1.02a: Removed 8.4 max spec from DLL=0 AC Timing diagram)</li> </ul>

# Mouser Electronics

Authorized Distributor

Click to View Pricing, Inventory, Delivery & Lifecycle Information:

[GSI Technology:](#)

[GS82612DT37CE-250MV](#)