



**ZT483E/ZT485E/ZT488E/ZT489E/ZT490E/ZT491E**  
**Low Power 5V 250Kbps/10Mbps RS485 Transceivers**

---

**ZT483E/ZT485E/ZT488E/ZT489E/ZT490E/ZT491E**  
**Low Power 5V 250Kbps/10Mbps RS485 Transceivers**  
**Datasheet**

Revision 2.10  
May 13<sup>th</sup>, 2015





## **ZT483E/ZT485E/ZT488E/ZT489E/ZT490E/ZT491E Low Power 5V 250Kbps/10Mbps RS485 Transceivers**

---

### **IMPORTANT NOTICE**

Copyright © 2012-2015 ASIX Electronics Corporation. All rights reserved.

### **DISCLAIMER**

No part of this document may be reproduced or transmitted in any form or by any means, electronic or mechanical, including photocopying and recording, for any purpose, without the express written permission of ASIX. ASIX may make changes to the product specifications and descriptions in this document at any time, without notice.

ASIX provides this document “as is” without warranty of any kind, either expressed or implied, including without limitation warranties of merchantability, fitness for a particular purpose, and non-infringement.

Designers must not rely on the absence or characteristics of any features or registers marked “reserved”, “undefined” or “NC”. ASIX reserves these for future definition and shall have no responsibility whatsoever for conflicts or incompatibilities arising from future changes to them. Always contact ASIX to get the latest document before starting a design of ASIX products.

### **TRADEMARKS**

ASIX, the ASIX logo are registered trademarks of ASIX Electronics Corporation. All other trademarks are the property of their respective owners.



### Features

- Meets or exceeds the requirements of ANSI Standard TIA/EIA-485-A and ISO 8482:1987(E) specifications for  $V_{CC}$  at  $+5V \pm 10\%$
- Low quiescent current – 0.4mA typ., 0.9mA max.
- Low shutdown current (where applicable) - 1 $\mu$ A typical, 10 $\mu$ A max.
- Guaranteed standard data rate 250Kbps or 10Mbps
- True Fail-Safe (Open and Short) Receiver
- -7V to +12V common-mode input voltage range
- Half-Duplex or Full-Duplex configuration
- Allows up to 1 unit load (32 devices) on the same common bus
- Controlled driver output slew rate and receiver input filtering
- Active-high driver enable and active-low receiver enable
- ESD Protection on bus terminals  $\pm 15KV$  Human Body Model (HBM)
- Drop-in Replacements for MAX483E, MAX485E, MAX488E, MAX489E, MAX490E, MAX491E.
- High fanout driving 1/8 unit load (256 devices) available on the ZT485H Series

ZT483E/ZT485E

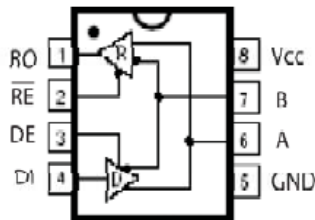

### • Product Selection Guide and Cross Reference

Part Number	Duplex	# Of Tx/Rx	Data Rate (Mbps)	# of Tx/Rx on Bus	Slew Rate Limit	Rx Input Filtering	Low-Power Shutdown	Tx/Rx Enable	ESD on Tx/Rx	Package Types	Pin-to-Pin Cross Reference
ZT483E	Half	1/1	0.25	32	Yes	Yes	Yes	Yes	$\pm 15KV$	8-PDIP, 8-nSOIC	MAX483E
ZT485E	Half	1/1	10	32	No	No	Yes	Yes	$\pm 15KV$	8-PDIP, 8-nSOIC	MAX485E
ZT488E	Full	1/1	0.25	32	Yes	Yes	No	No	$\pm 15KV$	8-PDIP, 8-nSOIC	MAX488E
ZT489E	Full	1/1	0.25	32	Yes	Yes	Yes	Yes	$\pm 15KV$	14-PDIP, 14-nSOIC	MAX489E
ZT490E	Full	1/1	10	32	No	No	No	No	$\pm 15KV$	8-PDIP, 8-nSOIC	MAX490E
ZT491E	Full	1/1	10	32	No	No	Yes	Yes	$\pm 15KV$	14-PDIP, 14-nSOIC	MAX491E

### General Description

The ZT485E series devices are 5V differential data line transceivers for RS485/RS422 communication that consist of one driver and one receiver with high level of ESD protection. They are designed for balanced transmission lines interface that meet ANSI standard TIA/EIA-485-A and ISO 8482:1987(E) specifications.

The ZT485E series devices span out with half or full duplex, data rate guaranteed at 250K bit per second or 10Mbps, and allow one unit load that fan out 32 devices sharing a common bus. The I/Os are enhanced-electrostatic discharge (ESD) protected, exceeding  $\pm 15KV$  Human Body Model (HBM).

### Applications

- RS422/RS485 communications
- Utility meters
- Industrial process control
- Building automation
- Level translators
- Transceivers for EMI-sensitive applications
- Routers and HUBs
- Industrial-controlled Local Area Networks
- Industrial PCs, embedded PCs and peripherals



# ZT483E/ZT485E/ZT488E/ZT489E/ZT490E/ZT491E Low Power 5V 250Kbps/10Mbps RS485 Transceivers

## Absolute Maximum Ratings

These are stress ratings only and functional operation of the device at these ratings or any other above those indicated in the operation sections of the specifications is not implied. Exposure to absolute maximum rating conditions for extended periods of time may affect reliability.

Power Supply, (VCC) .....-0.3V to +7.0V

### Input Voltages

DI, DE,  $\overline{RE}$  ..... -0.3V to (VCC +0.3V)  
Differential Input Voltage, (VID) ..... -12V to +12V  
A, B (Vi) ..... -9V to +13V

### Output Voltages

RO .....-0.3V to +6.0V  
Y, Z (A & B on Half Duplex) .....-9V to +13.0V

Operating Temperature .....-40°C to +85°C  
Storage Temperature .....-65°C to +150°C

### Power Dissipation Per Package

8-pin PDIP (derate 9.09mW/°C above +70°C) .....722mW  
8-pin nSOIC (derate 6.14mW/°C above +70°C) .....500mW  
14-pin PDIP (derate 10.00mW/°C above +70°C) ....800mW  
14-pin nSOIC (derate 8.33mW/°C above +70°C) ....667mW

## Storage Considerations

Storage in a low humidity environment is preferred. Large high density plastic packages are moisture sensitive and should be stored in Dry Vapor Barrier Bags. Prior to usage, the parts should remain bagged and stored below 40°C and 60%RH. If the parts are removed from the bag, they should be used within 168 hours or stored in an environment at or below 20%RH. If the above conditions cannot be followed, the parts should be baked for 12 hours at 125°C in order to remove moisture prior to soldering. ASIX ships product in Dry Vapor Barrier Bags with a humidity indicator card and desiccant pack. The humidity indicator should be below 30%RH. The MSL of this product is 3.

The information furnished by ASIX has been carefully reviewed for accuracy and reliability. Its application or use, however, is solely the responsibility of the user. No responsibility of the use of this information become part of the terms and conditions of any subsequent sales agreement with ASIX. Specifications are subject to change without the responsibility for any infringement of patents or other rights of third parties which may result from its use. No license or proprietary rights are granted by implication or otherwise under any patent or patent rights of ASIX Electronics Corporation.



## 1 DC Electrical Characteristics

Unless otherwise stated,  $V_{CC} = +5.0V$ ,  $T_A = T_{min}$  to  $T_{max}$ , typical values apply at  $V_{CC} = +5.0V$  and  $T_A = 25^\circ C$ .

Parameter	Condition	Min	Typ	Max	Units
<b>Operating Voltage &amp; Temperature</b>					
Temperature	Industrial Grade	-40	25	85	$^\circ C$
Vcc Voltage Range	$V_{CC} = +5.0V$	4.5	5	5.5	V
<b>Supply Current</b>					
I <sub>cc</sub> , Tx and Rx active	DI= V <sub>CC</sub> /GND, DE= V <sub>CC</sub> , $\overline{RE}$ =GND, RS485 I/O=Open		400	900	$\mu A$
I <sub>cc</sub> , Tx active	DI= V <sub>CC</sub> /GND, DE= V <sub>CC</sub> , $\overline{RE} = V_{CC}$ , RS485 I/O=Open		400	900	$\mu A$
I <sub>cc</sub> , Rx active	DI= V <sub>CC</sub> /GND, DE=GND, $\overline{RE}$ =GND, RS485 I/O=Open		400	900	$\mu A$
I <sub>SD</sub> , Shutdown Current (ZT483E, ZT485E, ZT489E and ZT491E Only)	DI= V <sub>CC</sub> /GND, DE = GND, $\overline{RE} = V_{CC}$ , RS485 I/O=Open		1	10	$\mu A$
<b>TTL LOGIC Input, Driver</b>					
Input Threshold Low, V <sub>IL</sub>	$V_{CC} = +5.0V$ , DE, DI, and $\overline{RE}$			0.8	V
Input Threshold High, V <sub>IH</sub>	$V_{CC} = +5.0V$ , DE, DI, and $\overline{RE}$	2			V
<b>TTL LOGIC Output, Receiver</b>					
Output Voltage Low, V <sub>OL</sub>	I <sub>OUT</sub> = +4mA, Input Differential Voltage = 200mV			0.4	V
Output Voltage High, V <sub>OH</sub>	I <sub>OUT</sub> = -4mA, Input Differential Voltage = 200mV	3.5			V
Output Leakage Current	Receiver Outputs Disabled, V <sub>OUT</sub> = 0.4V to 2.4V			$\pm 1$	$\mu A$
Short Circuit Current	V <sub>OUT</sub> = 0V to V <sub>CC</sub>	$\pm 7$		$\pm 95$	mA
<b>Receiver Input</b>					
Input Current	DE = 0V, V <sub>CC</sub> = 0V to 5.5V, V <sub>IN</sub> = +12V			1.0	mA
	DE = 0V, V <sub>CC</sub> = 0V to 5.5V, V <sub>IN</sub> = -7V			-0.8	mA
Differential Threshold Voltage, V <sub>TH</sub>	V <sub>CM</sub> = 0V, V <sub>CC</sub> = +5.0V, T <sub>A</sub> = 25 $^\circ C$	-0.2		0.2	V
Input Hysteresis	V <sub>CM</sub> = 0V		20		mV
Input Resistance, R <sub>IN</sub>	V <sub>CM</sub> = -7V to +12V	12			K $\Omega$
<b>Transmitter Output</b>					
Differential Output Voltage, V <sub>OD1</sub>	No Load			5	V
Differential Output Voltage, V <sub>OD2</sub>	With R <sub>L</sub> = 50 $\Omega$ , Refer to Figure 1. (RS422)	2			V
	With R <sub>L</sub> = 27 $\Omega$ , Refer to Figure 1. (RS485)	1.5		5	V
Driver Common Mode Output, V <sub>OC</sub>	With R <sub>L</sub> = 27 $\Omega$ or 50 $\Omega$ . C <sub>L</sub> = 50pF. Refer to Figure 3.			3	V
Change in Voltage Magnitude for Differential States, $\Delta V_{OD}$	Differential Output Voltage, with R <sub>L</sub> = 27 $\Omega$ or 50 $\Omega$ , C <sub>L</sub> = 50pF Refer to Figure 1			0.2	V
Change in Voltage Magnitude for Common Mode States, $\Delta V_{OC}$	Common-Mode Output Voltage, with R <sub>L</sub> = 60 $\Omega$ /375 $\Omega$ /375 $\Omega$ . Refer to Figure 2.			0.2	V
Transmitter Short-Circuit Current	Output HIGH, V <sub>OUT</sub> = -7V to +12V. Refer to Figure 7.			250	mA
	Output LOW, V <sub>OUT</sub> = -7V to +12V. Refer to Figure 7.			250	mA



## ZT483E/ZT485E/ZT488E/ZT489E/ZT490E/ZT491E Low Power 5V 250Kbps/10Mbps RS485 Transceivers

### 2 AC Electrical Characteristics (ZT485E, ZT490E, ZT491E)

Unless otherwise stated, VCC = +5.0V, TA = T<sub>min</sub> to T<sub>max</sub>, typical values apply at VCC = +5.0V and TA = 25°C.

Parameter	Condition	Min	Typ	Max	Units
<b>Transmitter Timing</b>					
Transmitter Propagation t <sub>PLH</sub>	R <sub>DIFF</sub> = 54Ω, C <sub>L</sub> = 50pF. Refer to Figure 4.		35	60	ns
Transmitter Propagation t <sub>PHL</sub>	R <sub>DIFF</sub> = 54Ω, C <sub>L</sub> = 50pF. Refer to Figure 4.		35	60	ns
Transmitter Output Skew t <sub>SK</sub>	t <sub>PLH</sub> - t <sub>PHL</sub>		3	10	ns
Transmitter Rise/Fall Time	t <sub>r</sub> , t <sub>f</sub> , R <sub>DIFF</sub> = 54Ω, C <sub>L</sub> = 50pF. Refer to Figure 4.		15	25	ns
Transmitter Output Enable	To Output HIGH, C <sub>L</sub> = 50pF, R <sub>L</sub> = 110Ω. Refer to Figure 5.		50		ns
	To Output LOW, C <sub>L</sub> = 50pF, R <sub>L</sub> = 110Ω. Refer to Figure 6.		50		ns
Transmitter Output Disable	From Output HIGH, C <sub>L</sub> = 50pF, R <sub>L</sub> = 110Ω. Refer to Figure 5.		50		ns
	From Output LOW, C <sub>L</sub> = 50pF, R <sub>L</sub> = 110Ω. Refer to Figure 6.		50		ns
<b>Receiver Timing</b>					
Receiver Propagation t <sub>PLH</sub>	C <sub>L</sub> = 15pF, Refer to Figure 9.		50	150	ns
Receiver Propagation t <sub>PHL</sub>	C <sub>L</sub> = 15pF, Refer to Figure 9.		50	150	ns
Differential Receiver Skew t <sub>SK</sub>	t <sub>PLH</sub> - t <sub>PHL</sub>		10		ns
Receiver Output Enable	To Output HIGH, C <sub>L</sub> = 15pF. Refer to Figure 10.		50		ns
	To Output LOW, C <sub>L</sub> = 15pF. Refer to Figure 11.		50		ns
Receiver Output Disable	From Output HIGH, C <sub>L</sub> = 15pF. Refer to Figure 10.		50		ns
	From Output LOW, C <sub>L</sub> = 15pF. Refer to Figure 11.		50		ns
<b>Shutdown Timing (ZT485E and ZT491E ONLY)</b>					
Time to Shutdown, t <sub>SHDN</sub>			50	600	ns
Transmitter Enable from SHUTDOWN to Output HIGH	C <sub>L</sub> = 50pF, R <sub>L</sub> = 110Ω. Refer to Figure 5.		200		ns
Transmitter Enable from SHUTDOWN to Output LOW	C <sub>L</sub> = 50pF, R <sub>L</sub> = 110Ω. Refer to Figure 6.		200		ns
Receiver Enable from SHUTDOWN to Output HIGH	C <sub>L</sub> = 15pF, R <sub>L</sub> = 1KΩ. Refer to Figure 11.		200		ns
Receiver Enable from SHUTDOWN to Output LOW	C <sub>L</sub> = 15pF, R <sub>L</sub> = 1KΩ. Refer to Figure 11.		200		ns
<b>Transceiver Throughput</b>					
Maximum Data Rate	R <sub>L</sub> = 54Ω, C <sub>L</sub> = 50pF, T <sub>A</sub> = 25°C.	10			Mbps
<b>ESD Tolerance</b>					
ESD HBM	RS485 Inputs and Outputs		±15		KV
ESD HBM <sup>(1)</sup>	All Pins		±4		KV

(1) Tested in accordance with JEDEC Standard 22, Test Method A114-A and IEC 60749-26



### 3 AC Electrical Characteristics (ZT483E, ZT488E and ZT489E)

Unless otherwise stated, VCC = +5.0V, TA = T<sub>min</sub> to T<sub>max</sub>, typical values apply at VCC = +5.0V and TA = 25°C.

Parameter	Condition	Min	Typ	Max	Units
<b>Transmitter Timing</b>					
Transmitter Propagation t <sub>PLH</sub>	R <sub>DIFF</sub> = 54Ω, C <sub>L</sub> = 50pF. Refer to Figure 4.	250	800	2000	ns
Transmitter Propagation t <sub>PHL</sub>	R <sub>DIFF</sub> = 54Ω, C <sub>L</sub> = 50pF. Refer to Figure 4.	250	800	2000	ns
Transmitter Output Skew t <sub>SK</sub>	t <sub>PLH</sub> - t <sub>PHL</sub>		20	800	ns
Transmitter Rise/Fall Time	t <sub>r</sub> , t <sub>f</sub> , R <sub>DIFF</sub> = 54Ω, C <sub>L</sub> = 50pF. Refer to Figure 4.	250		2000	ns
Transmitter Output Enable	To Output HIGH, C <sub>L</sub> = 50pF, R <sub>L</sub> = 110Ω. Refer to Figure 5.		100		ns
	To Output LOW, C <sub>L</sub> = 50pF, R <sub>L</sub> = 110Ω. Refer to Figure 6.		100		ns
Transmitter Output Disable	From Output HIGH, C <sub>L</sub> = 50pF, R <sub>L</sub> = 110Ω. Refer to Figure 5.		100		ns
	From Output LOW, C <sub>L</sub> = 50pF, R <sub>L</sub> = 110Ω. Refer to Figure 6.		100		ns
<b>Receiver Timing</b>					
Receiver Propagation t <sub>PLH</sub>	C <sub>L</sub> = 15pF, Refer to Figure 9.			2000	ns
Receiver Propagation t <sub>PHL</sub>	C <sub>L</sub> = 15pF, Refer to Figure 9.			2000	ns
Differential Receiver Skew t <sub>SK</sub>	t <sub>PLH</sub> - t <sub>PHL</sub>		10		ns
Receiver Output Enable	To Output HIGH, C <sub>L</sub> = 15pF. Refer to Figure 10.		100		ns
	To Output LOW, C <sub>L</sub> = 15pF. Refer to Figure 11.		100		ns
Receiver Output Disable	From Output HIGH, C <sub>L</sub> = 15pF. Refer to Figure 10.		100		ns
	From Output LOW, C <sub>L</sub> = 15pF. Refer to Figure 11.		100		ns
<b>Shutdown Timing (ZT483E and ZT489E ONLY)</b>					
Time to Shutdown, t <sub>SHDN</sub>			50	600	ns
Transmitter Enable from SHUTDOWN to Output HIGH	C <sub>L</sub> = 50pF, R <sub>L</sub> = 110Ω. Refer to Figure 5.		200		ns
Transmitter Enable from SHUTDOWN to Output LOW	C <sub>L</sub> = 50pF, R <sub>L</sub> = 110Ω. Refer to Figure 6.		200		ns
Receiver Enable from SHUTDOWN to Output HIGH	C <sub>L</sub> = 15pF, R <sub>L</sub> = 1KΩ. Refer to Figure 11.		200		ns
Receiver Enable from SHUTDOWN to Output LOW	C <sub>L</sub> = 15pF, R <sub>L</sub> = 1KΩ. Refer to Figure 11.		200		ns
<b>Transceiver Throughput</b>					
Maximum Data Rate	R <sub>L</sub> = 54Ω, C <sub>L</sub> = 50pF, T <sub>A</sub> = 25°C.	0.25			Mbps
<b>ESD Tolerance</b>					
ESD HBM	RS485 Inputs and Outputs		±15		KV
ESD HBM <sup>(1)</sup>	All Pins		±4		KV

(1) Tested in accordance with JEDEC Standard 22, Test Method A114-A and IEC 60749-26

## 4 Pin Description

Pin Numbers			Pin Name	Pin Description
Half Duplex	Full Duplex			
ZT483E	ZT488E	ZT489E		
ZT485E	ZT490E	ZT491E		
1	2	2	RO	Receiver Output. If A>B by 200mV, then RO = HIGH; If A<B by 200mV, then RO = LOW
2	n/a	3	$\overline{RE}$	Receiver Output Enable Low active input. RO is high-Z when $\overline{RE}$ = HIGH
3	n/a	4	DE	Driver Output Enable. The transmitter outputs, Y and Z, are enabled when DE = HIGH. The outputs are high-Z when DE = LOW.
4	3	5	DI	Driver Input. A low on DI forces output Y low and output Z high. A high on DI will bring output Y high and output Z low
5	4	6, 7	GND	Analog Ground
n/a	5	9	Y	Non-inverting transmitter output
n/a	6	10	Z	Inverting transmitter output
6	n/a	n/a	A	Non-inverting transmitter output and non-inverting receiver input.
n/a	8	12	A	Non-inverting receiver input.
7	n/a	n/a	B	Inverting transmitter output and inverting receiver input.
n/a	7	11	B	Inverting receiver input
8	1	14	VCC	Power Supply Input, 5V $\pm$ 10%
n/a	n/a	1, 8, 13	NC	No Connect, Not internally connected.

## 5 Circuit Description

The ZT483E, ZT485E, ZT488E, ZT489E, ZT490E, and ZT491E are low-power transceivers for RS-485 and RS-422 communications. The RS-485 standard is ideal for multi-drop applications and for long-distance interfaces. The TIA/EIA-485 specification allows up to 32 drivers and 32 receivers to be connected to a data bus, making it an ideal choice for multidrop applications. RS-485 transceivers are equipped with a wide (-7V to +12V) common mode range to accommodate ground potential differences since the cabling can be as long as 4,000 feet. As RS-485 is a differential interface, data is virtually immune to noise in the transmission line.

The ZT483E, ZT488E, and ZT489E are slew-rate limited, minimizing EMI and reducing reflections caused by improperly terminated cables.

### RS-485 Transmitters

Each device in the ZT4xxE family contains a differential output line transmitter that can drive voltage into multiple loads on a terminated two-wire pair, and a receiver that accepts a differential voltage down to 200mV. The transmitter's differential output can comply with RS-485 and also RS-422 standards. The typical voltage output swing with no load is 0V to Vcc. With worst case loading of 54 ohms across the differential outputs, the drivers can maintain greater than 1.5V voltage levels, which is more than adequate for a differential receiver to acknowledge a logic state. The 54 ohms is the equivalent of two 120 ohm termination resistors placed on each side of the transmission line and the input impedance of 32 receivers on the line.

The ZT485E transmitter has an enable control line which is active HIGH. A logic HIGH on DE (pin 3) will enable the differential outputs. A logic LOW on DE (pin 3) will disable the transmitter outputs. While disabled, the transmitter outputs are in high impedance.

### RS-485 Receivers

Each transceiver contains one differential receiver that has an input sensitivity of 200mV. The input impedance of the receivers is typically 15K ohms. A wide common mode range of -7V to +12V allows for large ground potential differences between systems.

The ZT483E, ZT485E, ZT489E, and ZT491E receivers have an enable control input. A logic LOW on  $\overline{RE}$  will enable the receiver, a logic HIGH on  $\overline{RE}$  will disable the receiver. The receivers are equipped with the fail-safe feature, which guarantees that the receiver output will be in a HIGH state when the input is left unconnected. This applies for both cases where the receiver inputs are either shorted or open.

The ZT485E, ZT490E, and ZT491E can transmit and receive at data rates up to 10Mbps. The ZT483E, ZT488E, and ZT489E are specified for data rates up to 250Kbps.

## Bus Configuration

The ZT488E, ZT489E, ZT490E, and ZT491E are full-duplex transceivers, while the ZT483E and ZT485E are half-duplex.

For full duplex, the devices are used as a four-wire bus transceiver with a configuration that the transmitters and receivers are moving data independent of each other. Transmit can occur on a dedicated two-wire pair and receive can occur on an adjacent two-wire pair, with each pair transferring data at up to 10Mbps (up to 250Kbps for the ZT488E and ZT489E).

Half duplex is a configuration where the transmitter outputs are connected to its receiver inputs. This application is common for two-wire interfaces where either the transmitter is active or the receiver is active. It is common to connect the enable inputs for the transmitter and receiver together so that a logic HIGH will enable the transmitter and disable the receiver. Conversely, a logic LOW will disable the transmitter and enable the receiver. Half-duplex configuration and these devices are designed for bidirectional data transmission on multipoint twisted-pair cables for applications, such as digital motor controllers, remote sensors and terminals, industrial process control, security stations and environmental control systems.

## ESD Immunity

Electro-Static Discharge (ESD) is an important factor when implementing a serial port into a system, especially in harsh environmental conditions. These industrial strength devices provide extra protection against ESD and are intended for harsh environments where high-speed data communication is important.

All of the ZT485E family of transceivers incorporates internal protection structures on all pins to protect against ESD charges encountered during handling and assembly. The driver outputs and receiver inputs have extra protection against static electricity as they are directly interfacing to the outside environment. As such, these pins against ESD of  $\pm 15\text{KV}$  without damage in all states of the transceiver's operation in the static state. After multiple ESD events, ASIX's ZT485E family of transceivers keep working without latchup. These devices eliminate the need for external transient suppressor diodes and the associated high capacitance loading, allowing reliable high-speed data communications.

The Human Body Model has been the generally accepted ESD testing method for semiconductors. This test is intended to simulate the human body's potential to store electrostatic energy and discharge it to an integrated circuit upon close proximity or contact. This method will test the IC's capability to withstand an ESD transient during normal handling such as in manufacturing areas where the ICs tend to be handled frequently.

## 6 Function Table

### ZT483E/ZT485E

DRIVER				RECEIVER		
Input DI	Enable DE	Outputs		Differential Inputs $V_{ID} = V_A - V_B$	Enable $\overline{RE}$	Output RO
		A	B			
H	H	H	L	$V_{ID} \leq -0.2V$	L	L
L	H	L	H	$-0.2V < V_{ID} < +0.2V$	L	U
X	L	Z	Z	$+0.2V \leq V_{ID}$	L	H
Open	H	H	L	X	H	Z
X	Open	Z	Z	X	Open	Z
				Open circuit	L	H*
				Short circuit	L	H*

### ZT488E/ZT490E

DRIVER			RECEIVER	
Input DI	Outputs		Differential Inputs $V_{ID} = V_A - V_B$	Output RO
	Y	Z		
H	H	L	$V_{ID} \leq -0.2V$	L
L	L	H	$-0.2V < V_{ID} < +0.2V$	U
Open	H	L	$+0.2V \leq V_{ID}$	H
			Open circuit	H*
			Short circuit	H*

### ZT489E/ZT491E

DRIVER				RECEIVER		
Input DI	Enable DE	Outputs		Differential Inputs $V_{ID} = V_A - V_B$	Enable $\overline{RE}$	Output RO
		Y	Z			
H	H	H	L	$V_{ID} \leq -0.2V$	L	L
L	H	L	H	$-0.2V < V_{ID} < +0.2V$	L	U
X	L	Z	Z	$+0.2V \leq V_{ID}$	L	H
Open	H	H	L	X	H	Z
X	Open	Z	Z	X	Open	Z
				Open circuit	L	H*
				Short circuit	L	H*

Note:

H = High Level; L = Low Level; Z = High Impedance; X = Irrelevant; U = Undetermined State.

\* = Fail Safe (Receiver Output High) when Receiver Inputs are Open or Short and Common Mode equals to 0V.

## 7 Pin Configuration

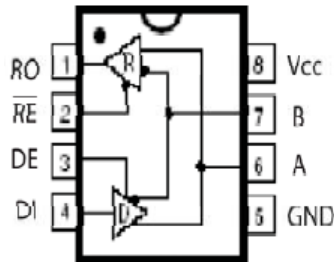
**ZT483E/ZT485E**

8-Pin PDIP/nSOIC

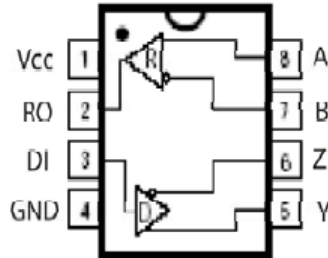
**ZT488E/ZT490E**

8-Pin PDIP/nSOIC

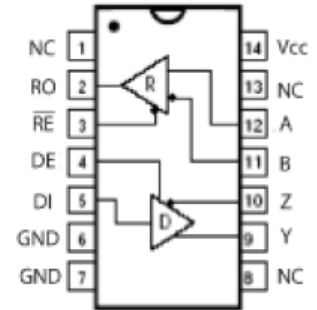
**ZT489E/ZT491E**

14-Pin PDIP/nSOIC

## 8 Typical Application Circuits

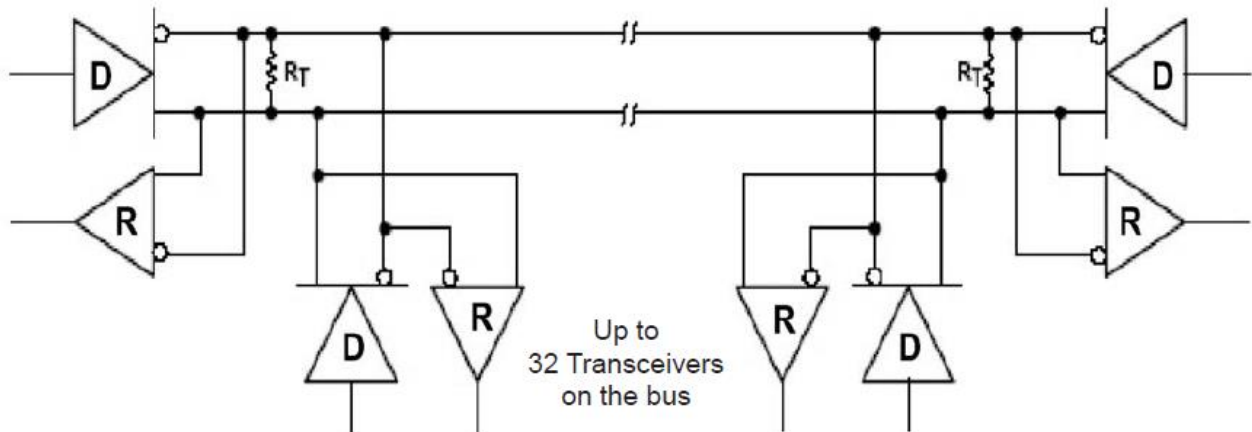
**Notes:**

- A. The bus should be terminated at both ends in its characteristic impedance of  $R_T = Z_0$ .
- B. Stub lengths off the main bus should be kept as short as possible.
- C. Can connect up to 32 devices on the same common bus.

## 9 Typical Test Circuits

Notes:

- A. The test load capacitance includes probe and test jig capacitance, unless otherwise specified.
- B. The signal generator had the following characteristics:  
 Pulse rate = 1000 KHz, 50% duty cycle,  $Z_0 = 50\Omega$ ,  $t_r$  &  $t_f < 6\text{ns}$ , unless otherwise specified.

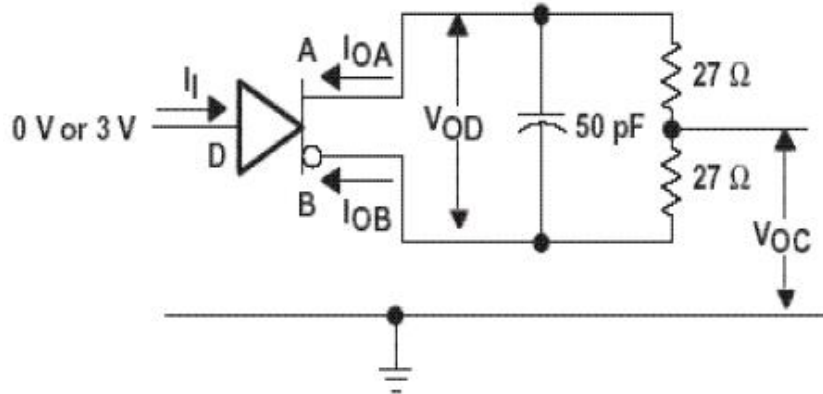

Figure 1. Driver Test Circuit, VOD and VOC Without Common-Mode Loading

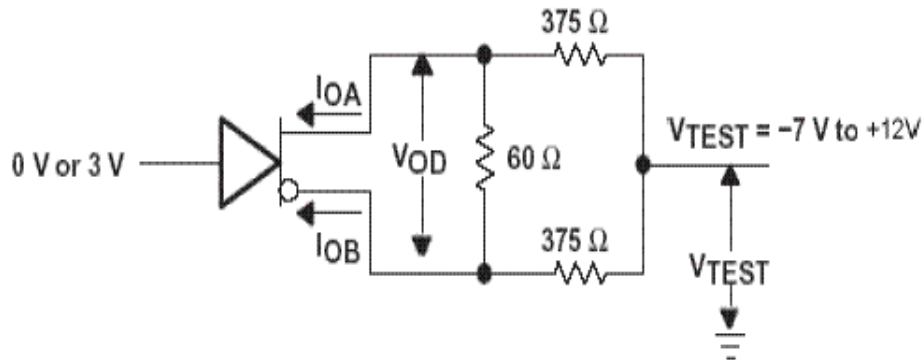

Figure 2. Driver Test Circuit, VOD With Common-Mode Loading

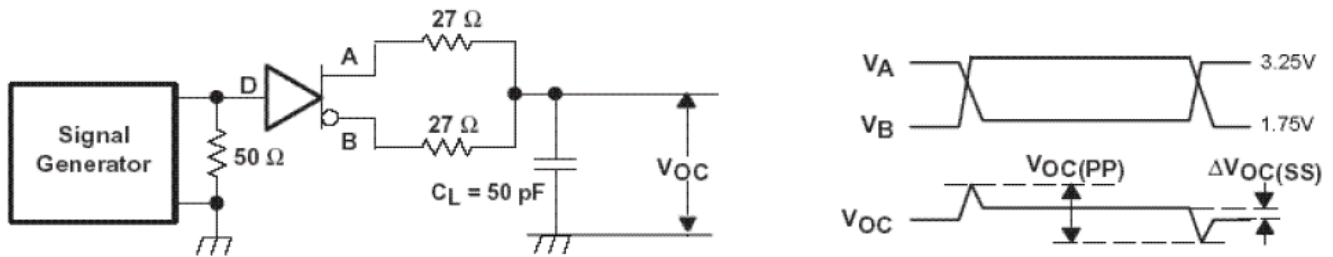

Figure 3. Driver Common-Mode Output Voltage (VOC) Test Circuit and Waveforms

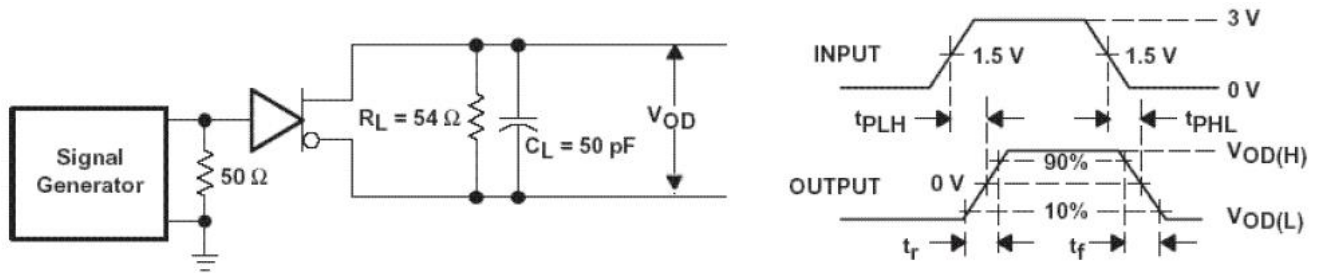

Figure 4. Driver Differential Output Voltage (VOD) Switching Test Circuit and Waveforms

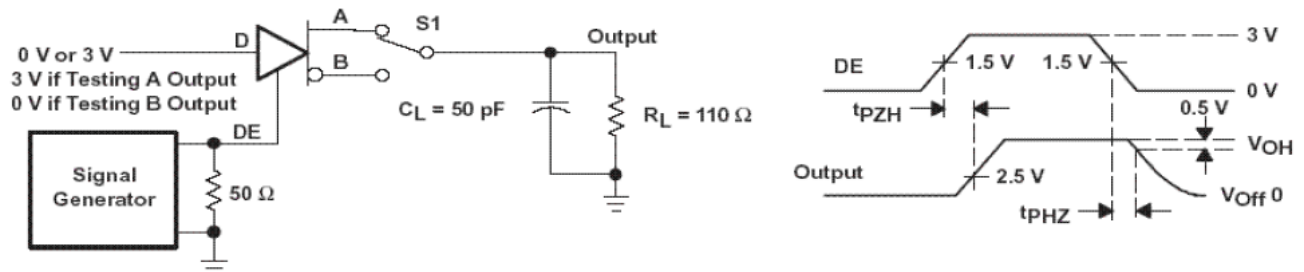

Figure 5. Driver Enable/Disable Test Circuit and Waveforms, High Output

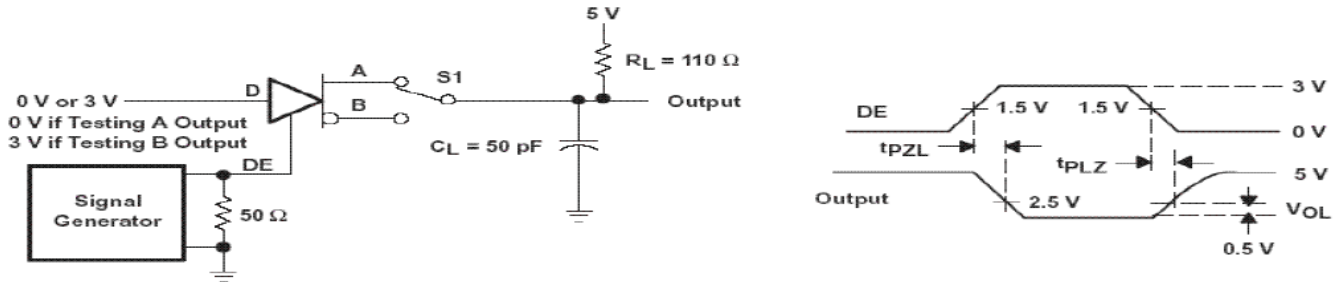

Figure 6. Driver Enable/Disable Test Circuit and Waveforms, Low Output

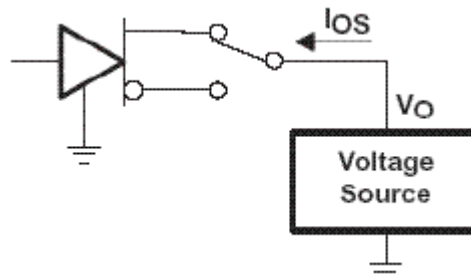

Figure 7. Driver Short-Circuit Test Configuration

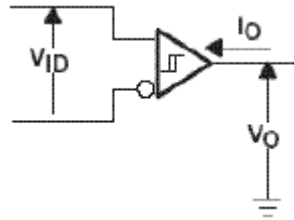

Figure 8. Receiver Parameter Definitions

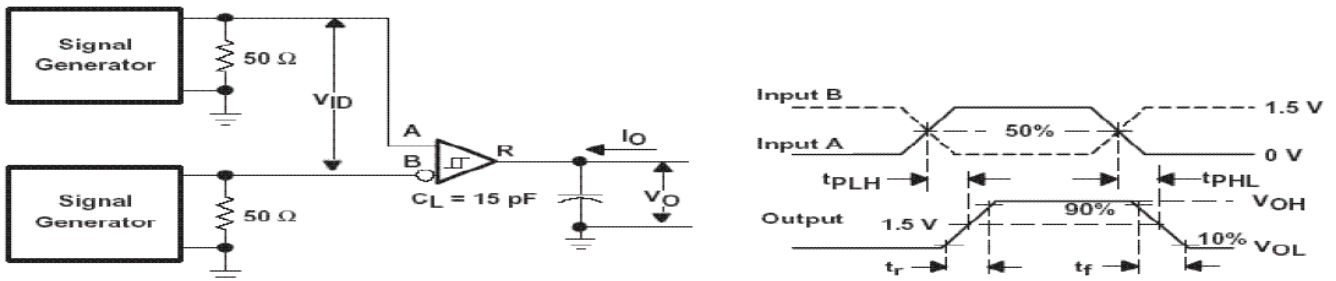

Figure 9. Receiver Propagation ( $t_{PLH}$  and  $t_{PHL}$ ) Test Circuit and Waveforms

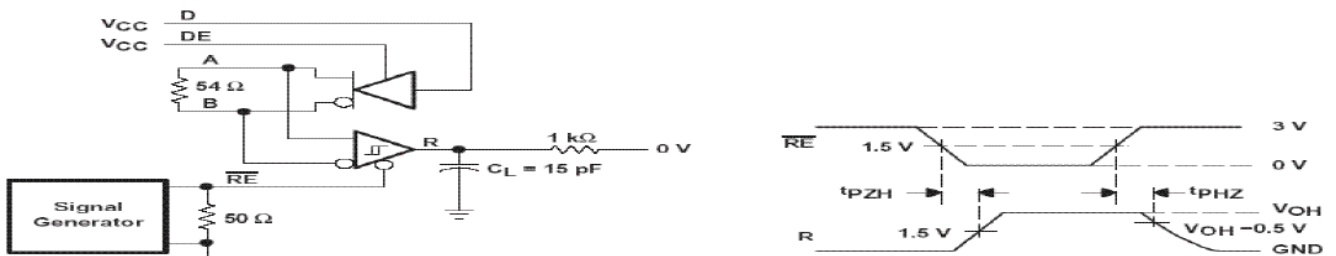

Figure 10. Receiver Output Enable/Disable Test Circuit and Waveforms, Data Output High

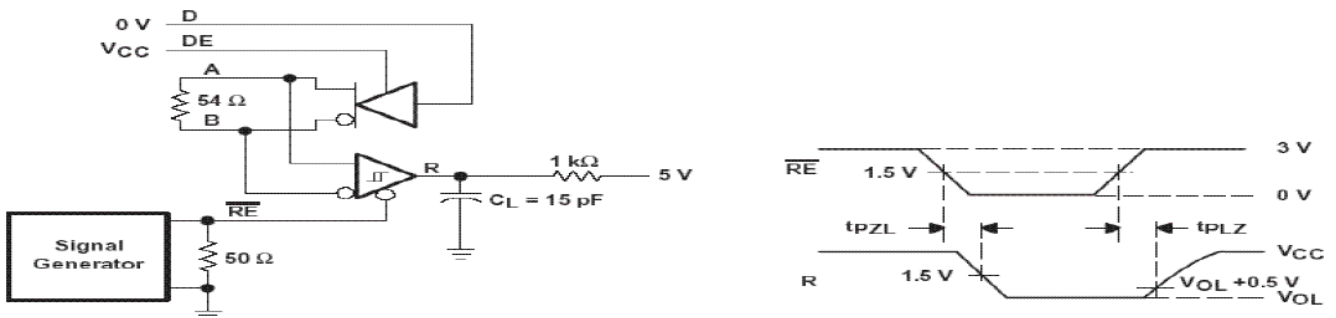
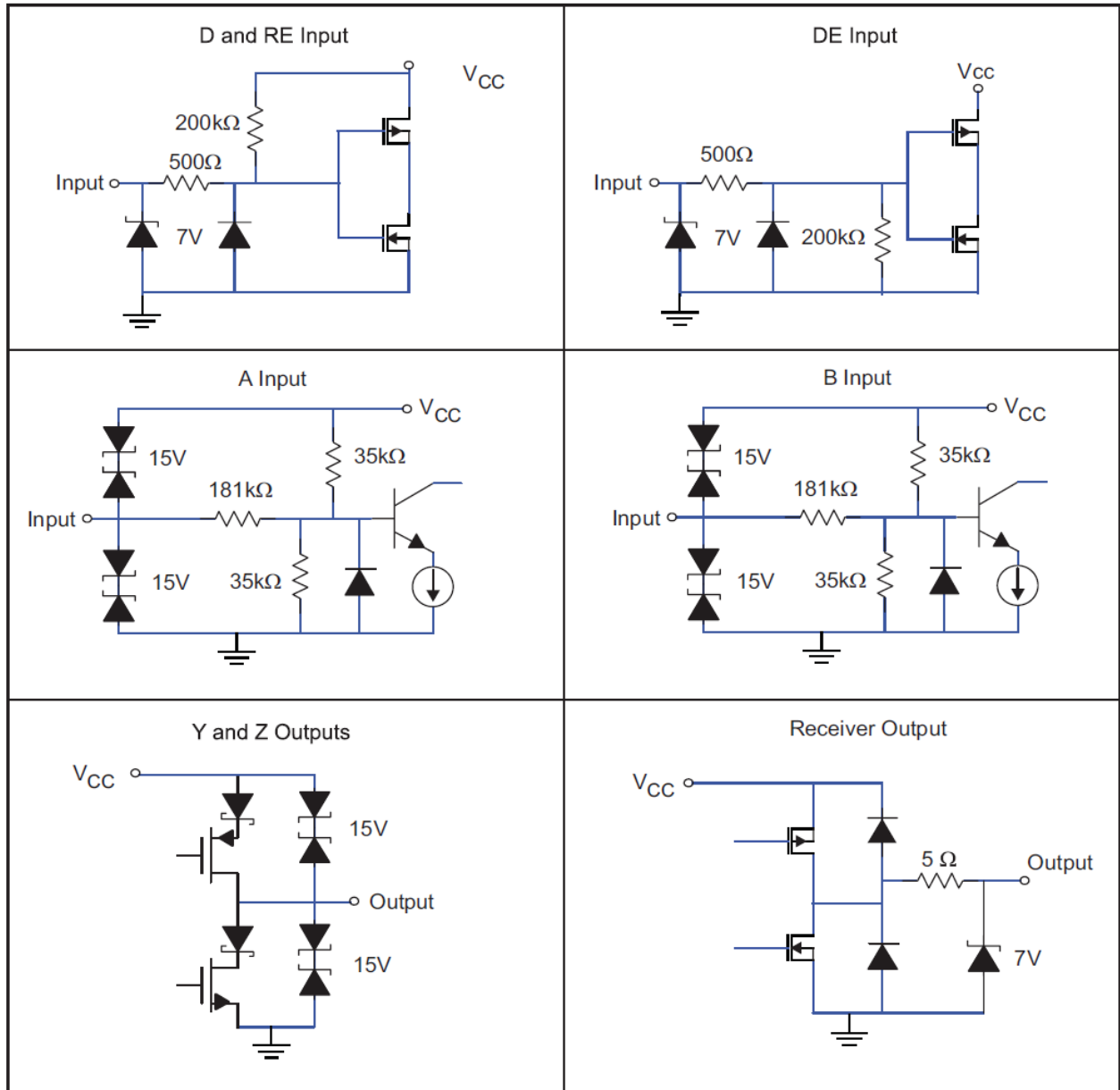
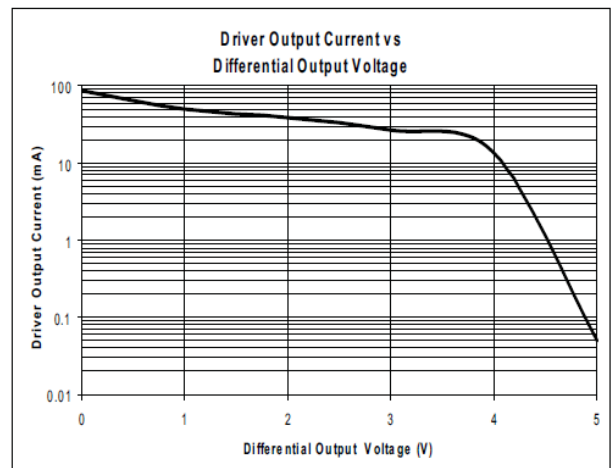
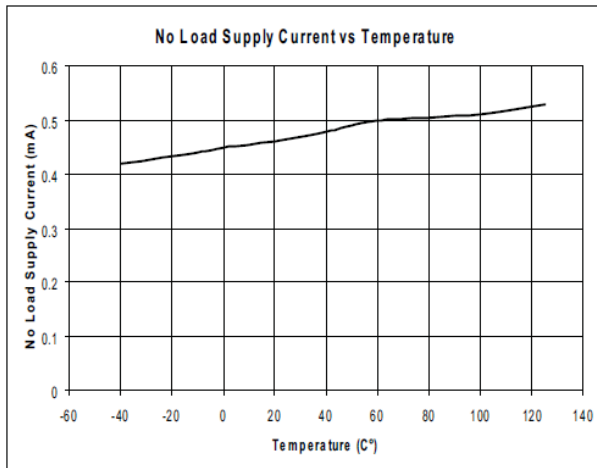
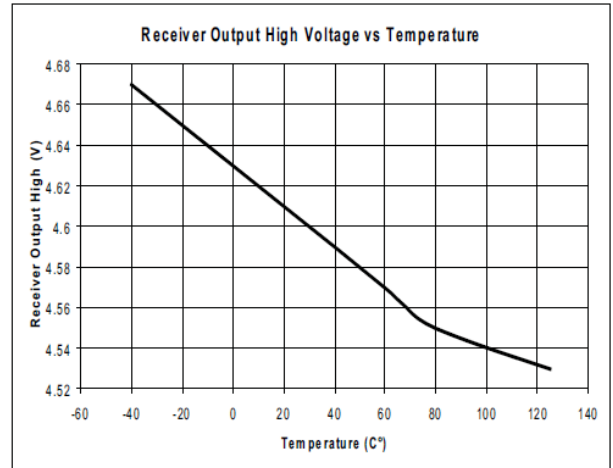
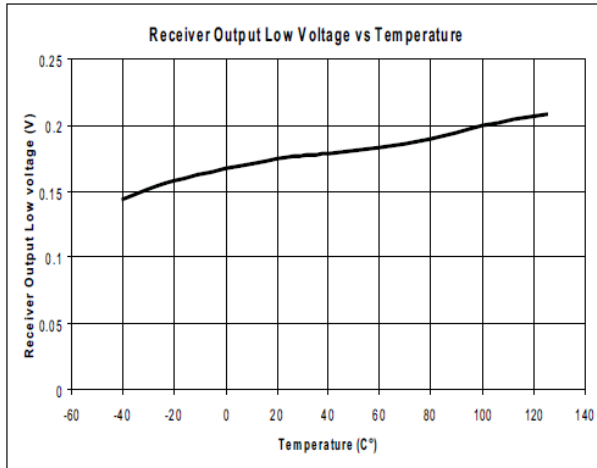
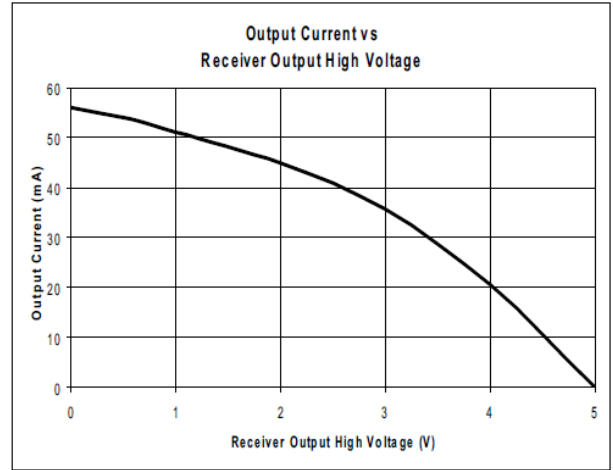
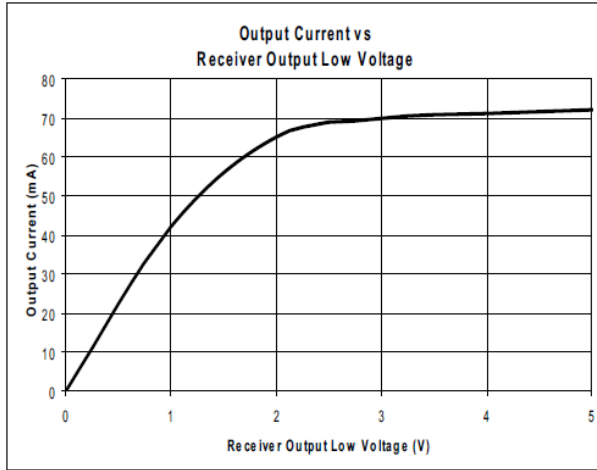

Figure 11. Receiver Output Enable/Disable Test Circuit and Waveforms, Data Output Low

## 10 Equivalent Input and Output Schematic Diagrams



## 11 Typical Performance Characteristics



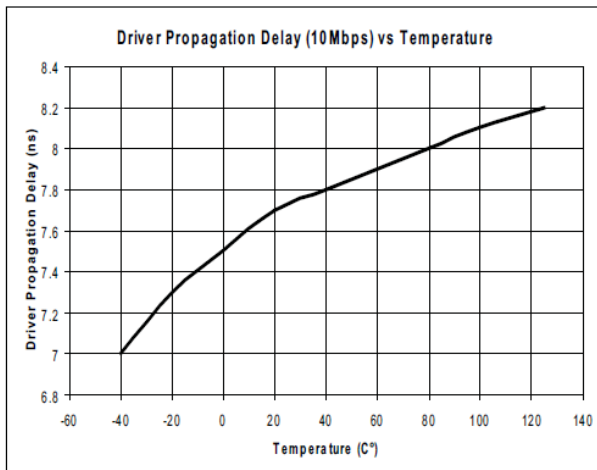
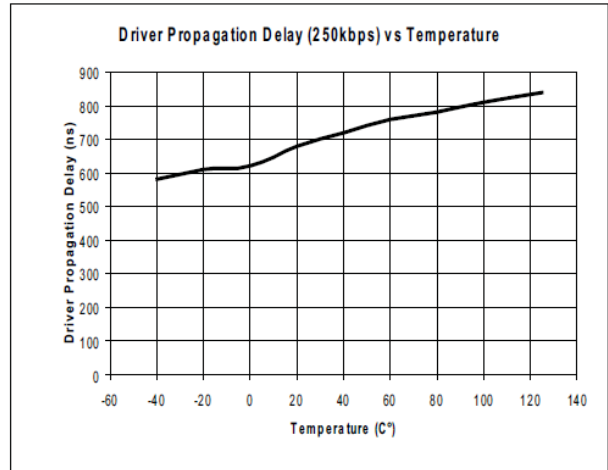
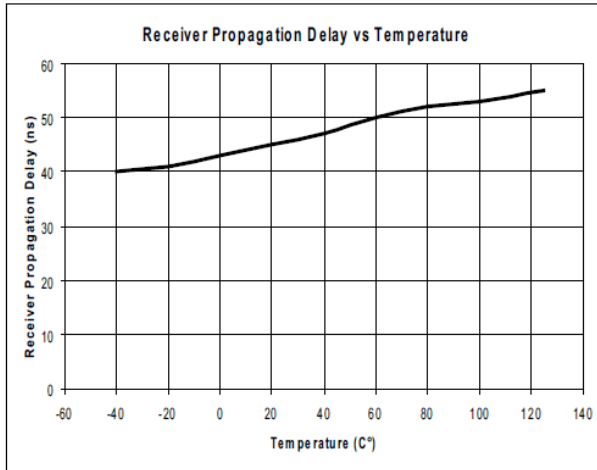

### 12 Package Information

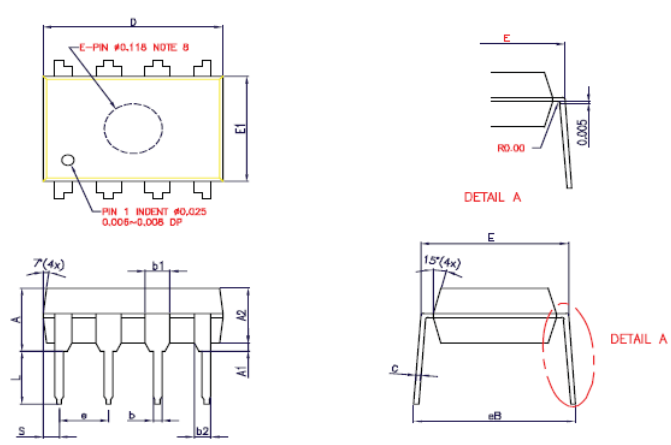

**NOTE :**

1. CONTROLLING DIMENSION : INCH
2. LEAD FRAME MATERIAL : C194
3. DIMENSION D AND E1 DO NOT INCLUDE MOLD FLASH OR PROTRUSIONS, MOLD FLASH OR PROTRUSIONS SHALL NOT EXCEED 0.010" [0.25mm]
4. DIMENSION "b1" DO NOT INCLUDE DAMBAR PROTRUSION, DAMBAR PROTRUSIONS SHALL NOT EXCEED 0.010" [0.25mm], DISTANCE BETWEEN LEADS INCLUDING DAMBAR PROTRUSIONS TO BE 0.006" [0.13mm] MINIMUM.
5. TOLERANCE : ±0.010" [0.25mm] UNLESS OTHERWISE SPECIFIED.
6. OTHERWISE DIMENSION FOLLOW ACCEPTABLE SPEC.
7. REFERENCE DOCUMENT : JEDEC SPEC MS-001-BA
8. BOTTOM E-PIN INDENT ARE MARKED AS BELOW:

SYMBOLS	DIMENSIONS IN MILLIMETERS			DIMENSIONS IN INCHES		
	MIN	NOM	MAX	MIN	NOM	MAX
A	3.6	3.9	4.2	0.142	0.154	0.165
A1	0.38	—	—	0.015	—	—
A2	3.25	3.30	3.45	0.128	0.130	0.136
b	0.38	0.48	0.56	0.015	0.019	0.022
b1	1.48	1.58	1.88	0.058	0.062	0.074
b2	0.813	0.99	1.14	0.032	0.039	0.045
C	0.20	0.25	0.30	0.008	0.010	0.012
D	9.12	9.30	9.53	0.359	0.368	0.375
E	7.62	7.87	8.26	0.300	0.310	0.325
E1	6.20	6.35	6.60	0.244	0.250	0.260
e	—	2.54	—	—	0.100	—
eB	8.38	—	9.40	0.330	—	0.370
L	3.18	—	—	0.125	—	—
S	0.71	0.84	0.97	0.028	0.033	0.038

**8-pin PDIP**

CUSTOMER : ZYWYN CORPORATION

APPROVED BY: [Signature] DATE: 01/24/00  
 DRAW BY: Sandy Sun  
 CHECK BY: Sun Sheng 01/28/00  
 APPROVAL: Paul Lee 01/27/00  
 APPROVAL: Barry Shen 1/27/00

TITLE : 8L P-DIP PACKAGE OUTLINE DRAWING FOR MITSUMI  
 DWG. NO. PO-DIP-019 REV. 0  
 UNIT : INCH SCALE : 6/1 SHEET 1 OF 1

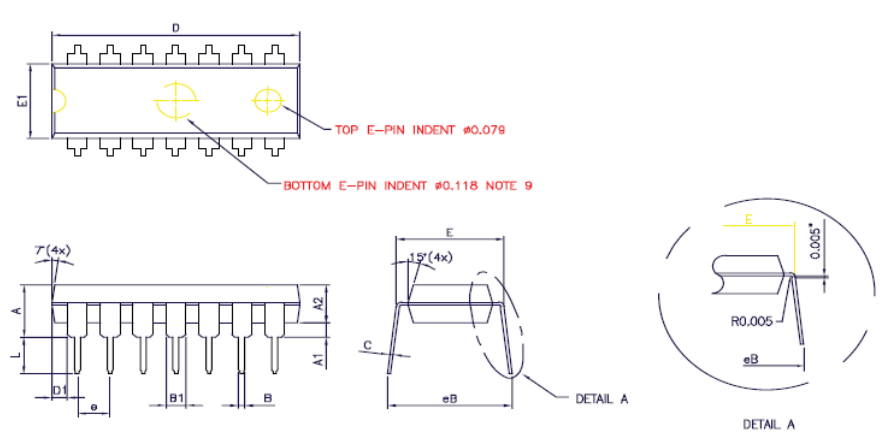

**NOTES :**

1. CONTROLLING DIMENSION : INCH
2. LEAD FRAME MATERIAL : C194
3. PACKAGE DIMENSION EXCLUDE MOLDING FLASH
4. AFTER SOLDER PLATING LEAD THICKNESS WILL BE 0.015" MAX
5. AFTER SOLDER DIPPING LEAD THICKNESS WILL BE 0.020" MAX
6. THE MAX. ALLOWABLE MOLDING FLASH IS 0.010"
7. TOLERANCE : 0.002" UNLESS OTHERWISE SPECIFIED
8. OTHERWISE DIMENSION FOLLOW ACCEPTABLE SPES
9. THE BOTTOM E-PIN INDENT IS MARKED AS BELOW :

SYMBOLS	DIMENSIONS IN MILLIMETERS			DIMENSIONS IN INCHES		
	MIN	NOM	MAX	MIN	NOM	MAX
A	—	—	4.57	—	—	0.180
A1	0.38	—	—	0.015	—	—
A2	3.25	3.30	3.45	0.128	0.130	0.136
B	0.26	0.46	0.56	0.014	0.018	0.022
B1	1.14	1.27	1.52	0.045	0.050	0.060
C	0.20	0.25	0.33	0.008	0.010	0.013
D	18.19	19.15	19.30	0.744	0.754	0.760
D1	0.81	1.19	1.47	0.032	0.047	0.058
E	7.62	—	8.26	0.300	—	0.325
E1	6.35	6.50	6.65	0.250	0.256	0.262
e	—	2.54	—	—	0.100	—
L	3.18	—	—	0.125	—	—
eB	8.63	—	9.65	0.340	—	0.380

**14-pin PDIP**

CUSTOMER : ZYWYN CORPORATION

APPROVED BY: [Signature] DATE: 05/12/00  
 DRAW BY: Paul Shen  
 CHECK BY: Thomas Kao 05/12/00  
 APPROVAL: Paul Lee 05/12/00  
 APPROVAL: Barry Shen 5/12/00

TITLE : 14L P-DIP PACKAGE OUTLINE DRAWING  
 DWG. NO. PO-DIP-002 REV. 0  
 UNIT : INCH SCALE : 4/1 SHEET 1 OF 1

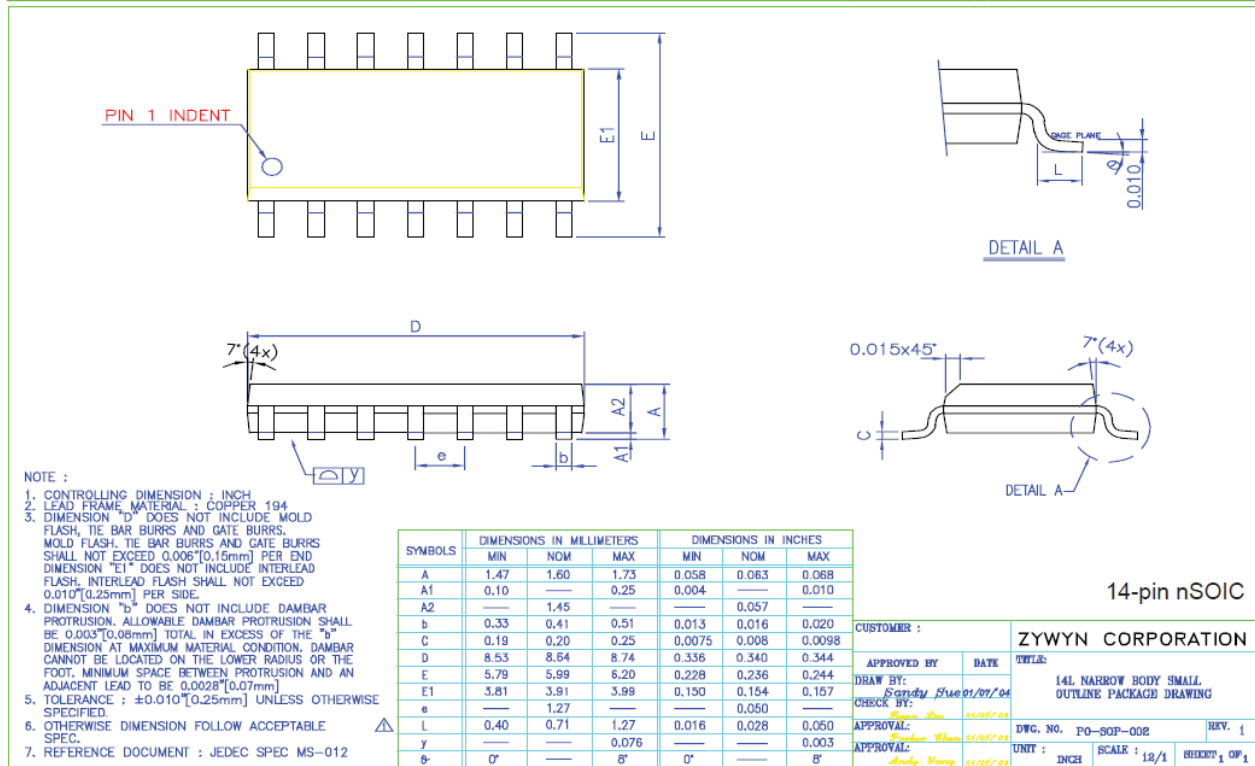
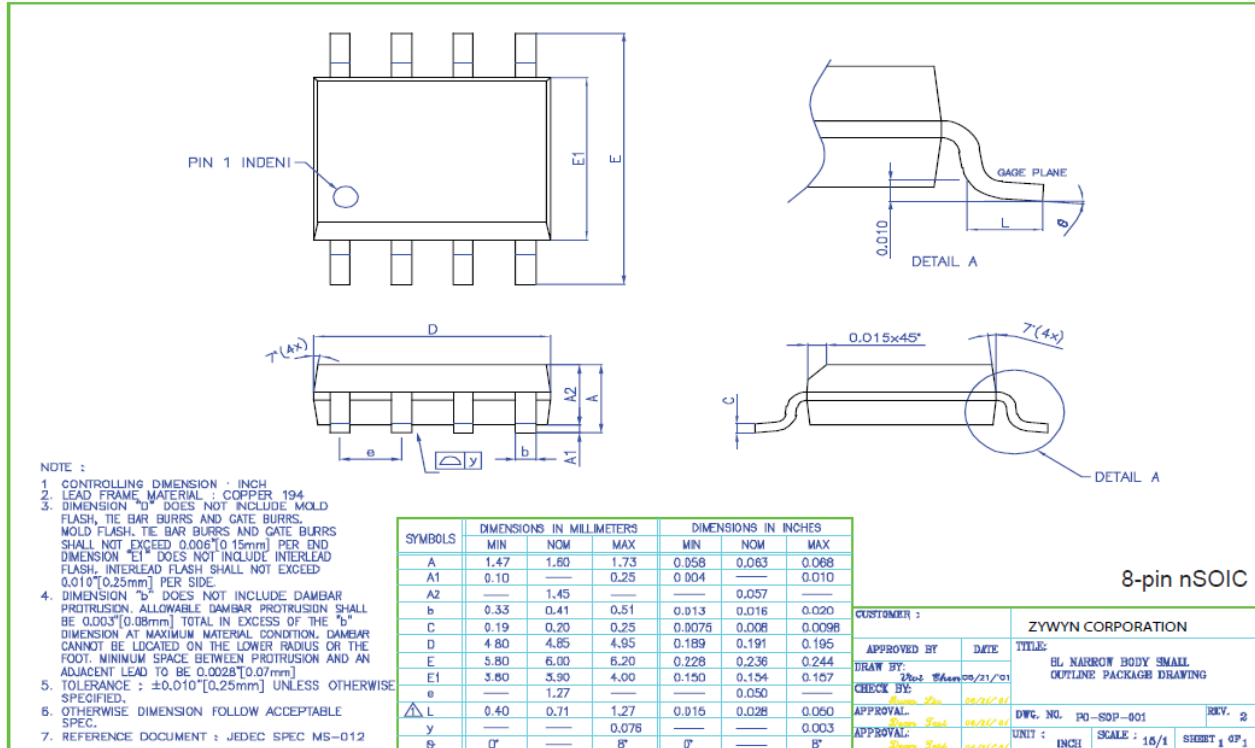

### 13 Green Package SMD IR Reflow Profile Information

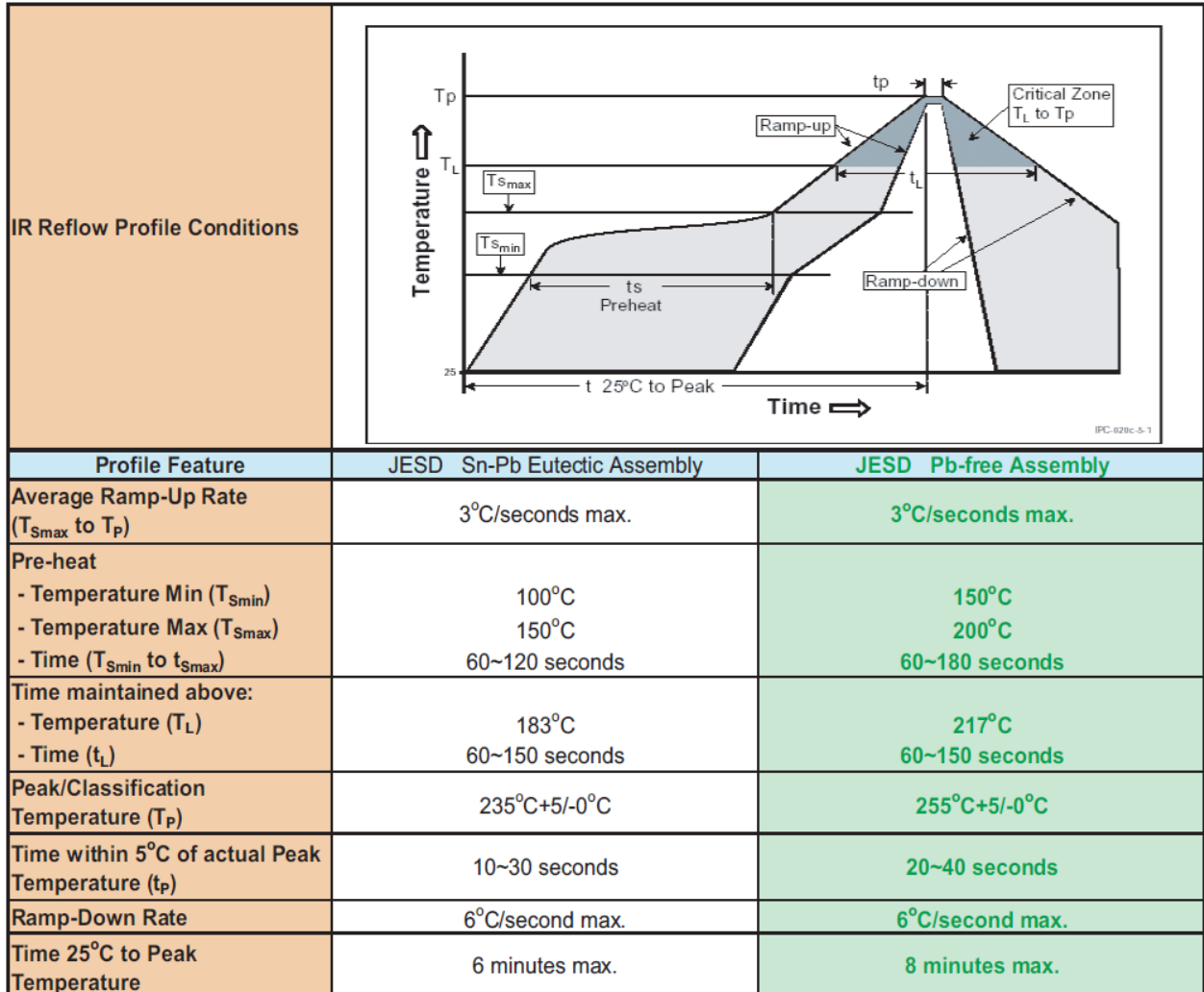

ASIX Green Packages are Pb-free and RoHS compliance.

## 14 Ordering Information

Part Number	Temperature Range	Package Type	Green Package (Pb-Free & RoHS)	MOQ /Tube	MOQ /T&R
ZT483LEEN	-40°C to +85°C	8-pin nSOIC	🌱	100	2500
ZT483LEEP	-40°C to +85°C	8-pin PDIP	🌱	60	N/A
ZT485LEEN	-40°C to +85°C	8-pin nSOIC	🌱	100	2500
ZT485LEEP	-40°C to +85°C	8-pin PDIP	🌱	60	N/A
ZT488LEEN	-40°C to +85°C	8-pin nSOIC	🌱	100	2500
ZT488LEEP	-40°C to +85°C	8-pin PDIP	🌱	60	N/A
ZT489LEEN	-40°C to +85°C	14-pin nSOIC	🌱	58	2500
ZT489LEEP	-40°C to +85°C	14-pin PDIP	🌱	30	N/A
ZT490LEEN	-40°C to +85°C	8-pin nSOIC	🌱	100	2500
ZT490LEEP	-40°C to +85°C	8-pin PDIP	🌱	60	N/A
ZT491LEEN	-40°C to +85°C	14-pin nSOIC	🌱	58	2500
ZT491LEEP	-40°C to +85°C	14-pin PDIP	🌱	30	N/A

Please contact the factory for pricing, availability on Tape-and-Reel and Die Sales options.

## 15 Part Marking Information

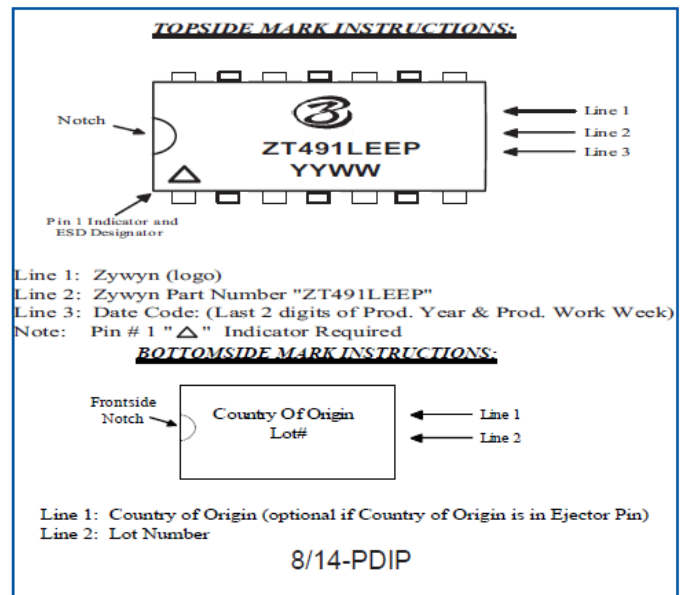
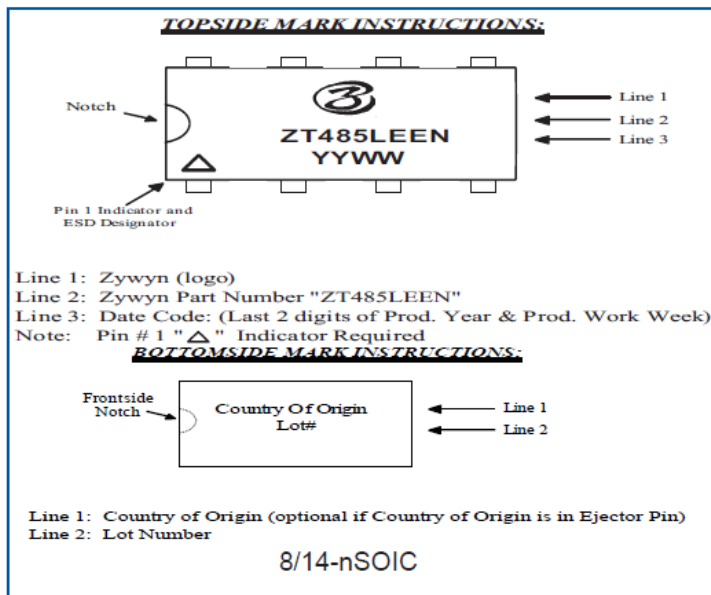



## Revision History

Revision	Date	Comment
V2.0	2012/07/01	Initial release to customers
V2.00	2015/04/28	<ol style="list-style-type: none"><li>1. Changed to ASIX Electronics Corp. logo, strings and contact information.</li><li>2. Added ASIX copyright legal header information.</li><li>3. Modified the Revision History table format.</li></ol>
V2.10	2015/05/13	<ol style="list-style-type: none"><li>1. Modified some information in Feature, Section 1 and 9.</li></ol>



**ZT483E/ZT485E/ZT488E/ZT489E/ZT490E/ZT491E**  
**Low Power 5V 250Kbps/10Mbps RS485 Transceivers**

---

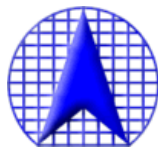

**ASIX** Electronics Corporation.

4F, No. 8, Hsin Ann Rd., HsinChu Science Park,  
HsinChu, Taiwan, R.O.C.

TEL: 886-3-5799500

FAX: 886-3-5799558

Sales Email: [sales@asix.com.tw](mailto:sales@asix.com.tw)

Support Email: [support@asix.com.tw](mailto:support@asix.com.tw)

Web: <http://www.asix.com.tw>