

# AN5790N, AN5792

## Horizontal Signal Processing ICs for CRT Display

### Overview

The AN5790N and AN5792 are the intergrated circuits designed for CRT display horizontal signal processing circuits.

### Features

- Horizontal synchronous signal is available in both polarities.
- Wide range of horizontal oscillation frequency : 14kHz to 60kHz.
- Output pulse width : 2μs to 40μs
- Package  
 AN5790N...NF-12S(12-Pin SIL plastic package)  
 AN5792...F-12S (12-Pin SIL plastic package with fin)

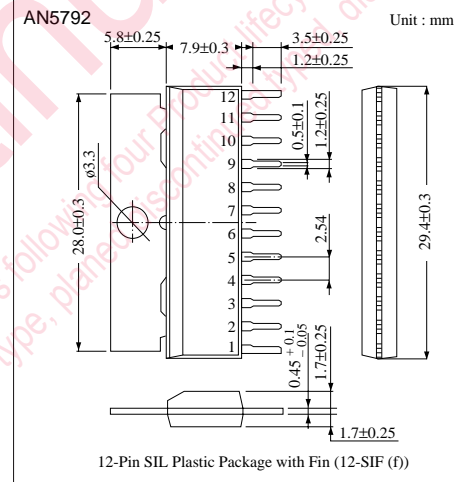
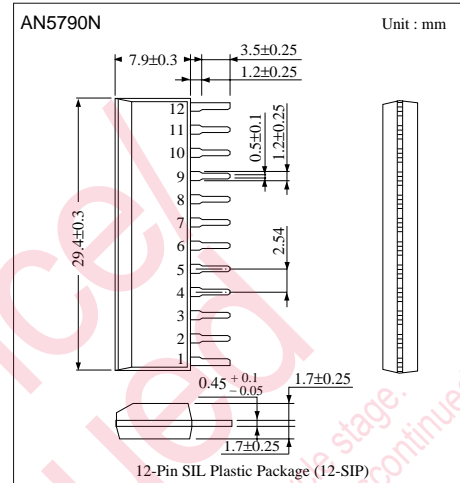

### Block Diagram

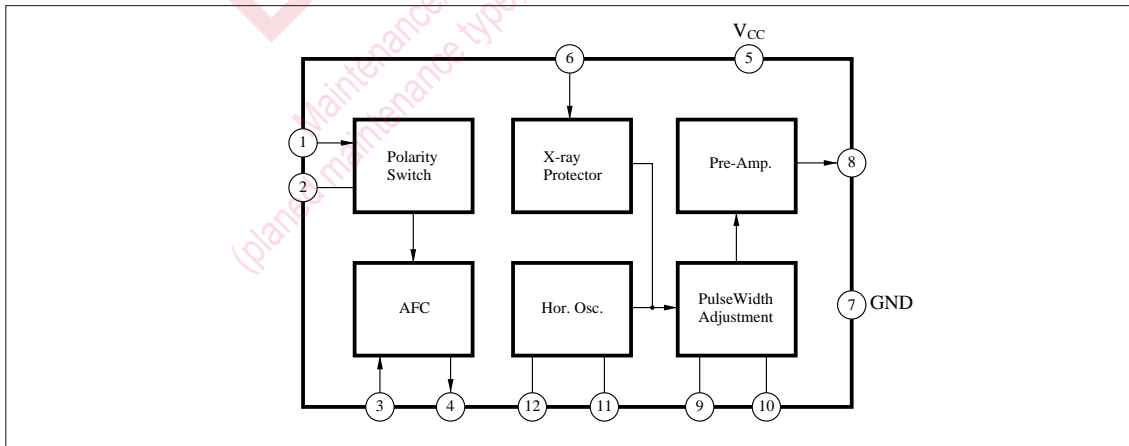

### ■ Absolute Maximum Ratings (Ta= 25°C)

Parameter		Symbol	Rating	Unit
Supply voltage		V <sub>CC</sub>	13.2	V
Supply current		I <sub>CC</sub>	50	mA
Power dissipation		P <sub>D</sub>	1140	mW
Temperature	Operating ambient temperature	T <sub>opr</sub>	- 20 to +70	°C
	Storage temperature	T <sub>stg</sub>	- 40 to +150	°C



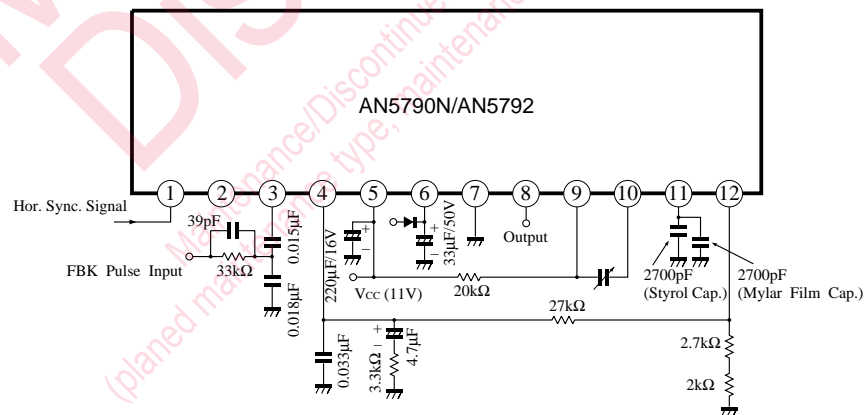

### ■ Electrical Characteristics (Ta= 25°C)

Parameter	Symbol	Condition	min	typ	max	Unit
Total circuit current	I <sub>tot</sub>	V <sub>CC</sub> =11V	30	45	60	mA
Polarity switching voltage (1)	V <sub>2-7</sub>	Positive polarity signal input	0	—	0.4	V
Polarity switching voltage (2)	V <sub>2-7</sub>	Negative polarity signal input	2.5	—	5.5	V
Horizontal oscillation start voltage	V <sub>osc-s (H)</sub>	f <sub>HO</sub> =12kHz to 19kHz	7.5	—	—	V
Horizontal oscillation frequency	f <sub>HO (1)</sub>	V <sub>CC</sub> =11V, C= 4400pF	15	15.75	16.5	kHz
Horizontal oscillation frequency	f <sub>HO (2)</sub>	V <sub>CC</sub> =11V, C= 820pF, 5600pF	14	—	60	kHz
f <sub>HO</sub> supply voltage dependency	Δf <sub>HO</sub> /V <sub>CC</sub>	f <sub>HO</sub> =15.75kHz, f <sub>HO</sub>   9.9V - f <sub>HC</sub>   12.1V	—	40	130	Hz
f <sub>HO</sub> ambient temperature dependency	Δf <sub>HO</sub> /Ta	f <sub>HO</sub> =15.75kHz, f <sub>HO</sub>   -20°C - f <sub>HC</sub>   60°C	—	—	260	Hz
Oscillation frequency control sensitivity	β	ΔI <sub>O</sub> = ±25μA	16	17.6	19.3	Hz/μA
DC loop gain	f <sub>DC</sub>	μ × β	—	700	—	Hz/μs
Output pulse width	τ <sub>HO (1)</sub>	V <sub>CC</sub> =11V, R= 20kΩ, C= 6800pF	17.8	19.4	21.2	μs
Output pulse width	τ <sub>HO (2)</sub>	V <sub>CC</sub> =11V, R=20kΩ, C=330pF, 18000pF	2	—	40	μs
Output pulse width variation to supply voltage change	Δτ <sub>HO</sub> /V <sub>CC</sub>	V <sub>CC</sub> = 9.9V to 12.1V	—	—	5	%
Output pulse width variation to temperature change	Δτ <sub>HO</sub> /Ta	V <sub>CC</sub> =11V, Ta= - 20°C to + 60°C	—	—	5	%
Oscillation output saturation voltage	V <sub>8-7</sub>	V <sub>CC</sub> =11V, V <sub>I0-7</sub> =1V	—	—	2	V
Oscillation output drive current	I <sub>8-7</sub>	V <sub>CC</sub> =11V, V <sub>I0-7</sub> =1V	300	—	—	mA
X-ray protecting circuit operation start voltage	V <sub>6-7</sub>	V <sub>CC</sub> =11V	0.5	0.64	0.75	V

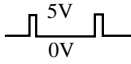
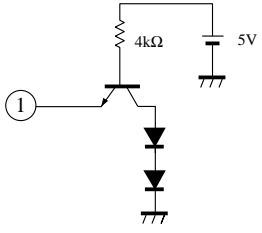
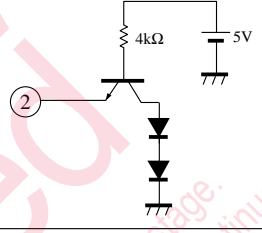

### ■ Application Circuit

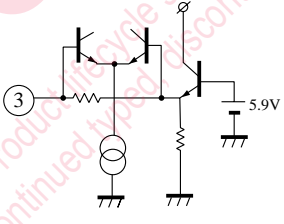
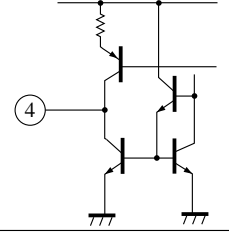
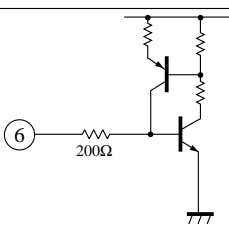

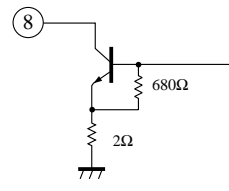
■ Pin Descriptions

Pin No.	Pin name	Typ. waveform	Description	Equivalent circuit
1	Horizontal synchronous signal input pin		Pin for inputting a horizontal synchronous signal.	
2	Polarity discrimination switching pin	DC	Both polarities of an input signal of Pin 1 are made available by connecting this pin to GND or setting it to OPEN	
3	Flyback pulse input pin		Flyback feedback pin. The standard value of amplitude is 1.5Vpp.	
4	AFC output pin	DC	Result of AFC detection.	
5	Supply voltage	DC	_____	_____
6	X-ray protecting circuit input pin	DC	When a voltage of 0.75V or more is applied, no horizontal output will not be generated.	
7	GND	DC	_____	_____
8	Horizontal drive output pin		Current when turned ON should be used at 300mA or less.	

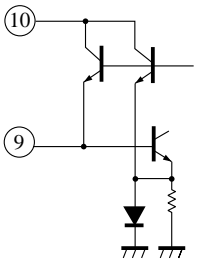
### ■ Pin Descriptions (cont.)

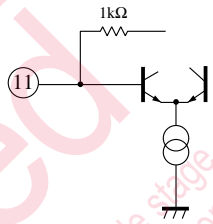
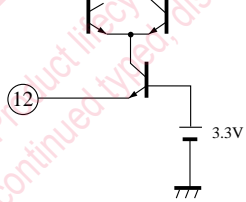
Pin No.	Pin name	Typ. waveform	Description	Equivalent circuit
9	Trigger input pin		The output pulse width can be changed by the capacitance between Pins9 and 10 and resistance between Pin10 and V <sub>CC</sub> .	
10	Pulse width adjusting pin			
11	Sawtooth wave generating pin		Oscillation frequency can be changed by the capacitor to be connected to this pin.	
12	Horizontal oscillation circuit reference voltage	DC	Oscillation frequency is changed by the resistor between this pin and GND.	

## Request for your special attention and precautions in using the technical information and semiconductors described in this book

- (1) If any of the products or technical information described in this book is to be exported or provided to non-residents, the laws and regulations of the exporting country, especially, those with regard to security export control, must be observed.
- (2) The technical information described in this book is intended only to show the main characteristics and application circuit examples of the products, and no license is granted under any intellectual property right or other right owned by our company or any other company. Therefore, no responsibility is assumed by our company as to the infringement upon any such right owned by any other company which may arise as a result of the use of technical information described in this book.
- (3) The products described in this book are intended to be used for standard applications or general electronic equipment (such as office equipment, communications equipment, measuring instruments and household appliances).  
Consult our sales staff in advance for information on the following applications:
  - Special applications (such as for airplanes, aerospace, automobiles, traffic control equipment, combustion equipment, life support systems and safety devices) in which exceptional quality and reliability are required, or if the failure or malfunction of the products may directly jeopardize life or harm the human body.
  - Any applications other than the standard applications intended.
- (4) The products and product specifications described in this book are subject to change without notice for modification and/or improvement. At the final stage of your design, purchasing, or use of the products, therefore, ask for the most up-to-date Product Standards in advance to make sure that the latest specifications satisfy your requirements.
- (5) When designing your equipment, comply with the range of absolute maximum rating and the guaranteed operating conditions (operating power supply voltage and operating environment etc.). Especially, please be careful not to exceed the range of absolute maximum rating on the transient state, such as power-on, power-off and mode-switching. Otherwise, we will not be liable for any defect which may arise later in your equipment.
  - Even when the products are used within the guaranteed values, take into the consideration of incidence of break down and failure mode, possible to occur to semiconductor products. Measures on the systems such as redundant design, arresting the spread of fire or preventing glitch are recommended in order to prevent physical injury, fire, social damages, for example, by using the products.
- (6) Comply with the instructions for use in order to prevent breakdown and characteristics change due to external factors (ESD, EOS, thermal stress and mechanical stress) at the time of handling, mounting or at customer's process. When using products for which damp-proof packing is required, satisfy the conditions, such as shelf life and the elapsed time since first opening the packages.
- (7) This book may be not reprinted or reproduced whether wholly or partially, without the prior written permission of Matsushita Electric Industrial Co., Ltd.