

7518A1311-0 ✓ ACTIVE

Raychem

TE Internal #: 440819-000

High Speed Digital & Data Cable, Coaxial, 75 Ω , 18AWG Wire Size,
Operating Temperature Range -55 – 115 °C

[View on TE.com >](#)



Wire & Cable > High Speed Digital & Data Cable

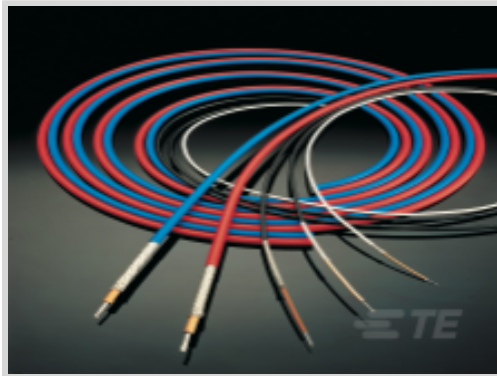

High Speed Digital & Data Cable Type: **Coaxial**

Impedance: **75 Ω**

Wire Size: **18 AWG**

Operating Temperature Range: **-55 – 115 °C**

Features

Product Type Features

| | |
|--------------------------------------|-----------------|
| Product Classification | Cable - Coaxial |
| Cable Style | Round Braided |
| Wire/Cable Type | Coaxial Cable |
| Product Type | Cable |
| High Speed Digital & Data Cable Type | Coaxial |

Electrical Characteristics

| | |
|-----------|-------------|
| | 17.1 pF/ft |
| Impedance | 75 Ω |

Signal Characteristics

| | |
|-------------------------|-----|
| Velocity of Propagation | 79% |
|-------------------------|-----|

Body Features

| | |
|--------------------|-------------------|
| Shield Material | Tin-Coated Copper |
| Shield Style | Single |
| Jacket Color | Black |
| Conductor Material | Tin-Plated Copper |
| Jacket Material | Thermorad F |

Dimensions

| | |
|--------------------------|-------------------|
| Overall Outside Diameter | 7.32 mm [.288 in] |
|--------------------------|-------------------|

| | |
|---------------------------|------------------|
| Cable Dielectric Diameter | 5.77 mm[.227 in] |
| Wire Diameter | 1.27 mm[.05 in] |
| Wire Size | 18 AWG |

Usage Conditions

| | |
|-----------------------------|--------------|
| Operating Temperature Range | -55 – 115 °C |
|-----------------------------|--------------|

Other

| | |
|---------------------|-------------------------------|
| Wire Source | United Kingdom, United States |
| Dielectric Material | Rayfoam L |

Product Compliance

[For compliance documentation, visit the product page on TE.com>](#)

| | |
|-----------------------------------------------|-------------------------------------------------------------------------------------------------------------------------------|
| EU RoHS Directive 2011/65/EU | Compliant |
| EU ELV Directive 2000/53/EC | Compliant |
| China RoHS 2 Directive MIIT Order No 32, 2016 | No Restricted Materials Above Threshold |
| EU REACH Regulation (EC) No. 1907/2006 | Current ECHA Candidate List: JUN 2020 (209) Candidate List Declared Against: JAN 2019 (197) Does not contain REACH SVHC |
| Halogen Content | Out of Scope - excluded from Halogen requirements |
| Solder Process Capability | Not applicable for solder process capability |

Product Compliance Disclaimer

This information is provided based on reasonable inquiry of our suppliers and represents our current actual knowledge based on the information they provided. This information is subject to change. The part numbers that TE has identified as EU RoHS compliant have a maximum concentration of 0.1% by weight in homogenous materials for lead, hexavalent chromium, mercury, PBB, PBDE, DBP, BBP, DEHP, DIBP, and 0.01% for cadmium, or qualify for an exemption to these limits as defined in the Annexes of Directive 2011/65/EU (RoHS2). Finished electrical and electronic equipment products will be CE marked as required by Directive 2011/65/EU. Components may not be CE marked. Additionally, the part numbers that TE has identified as EU ELV compliant have a maximum concentration of 0.1% by weight in homogenous materials for lead, hexavalent chromium, and mercury, and 0.01% for cadmium, or qualify for an exemption to these limits as defined in the Annexes of Directive 2000/53/EC (ELV). Regarding the REACH Regulation, the information TE provides on SVHC in articles for this part number is based on the latest European Chemicals Agency (ECHA) 'Guidance on requirements for substances in articles' posted at this URL: <https://echa.europa.eu/guidance-documents/guidance-on-reach>

Customers Also Bought

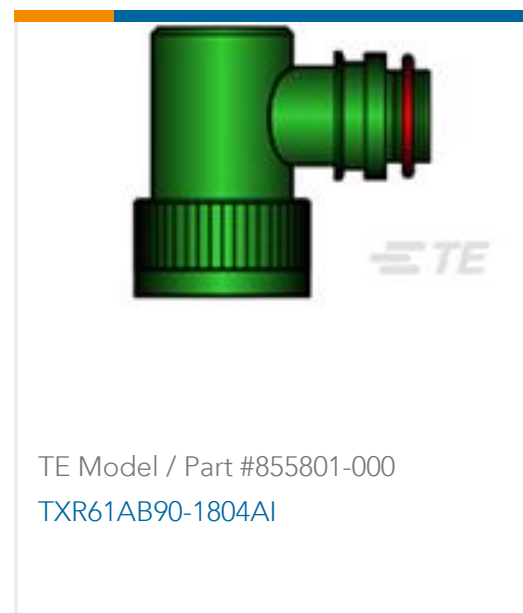
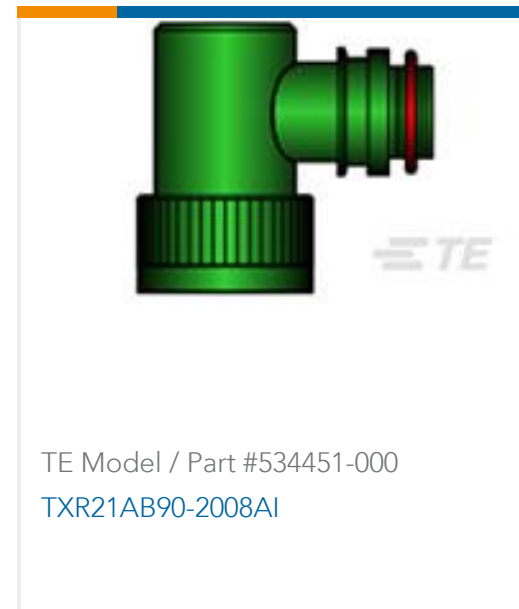
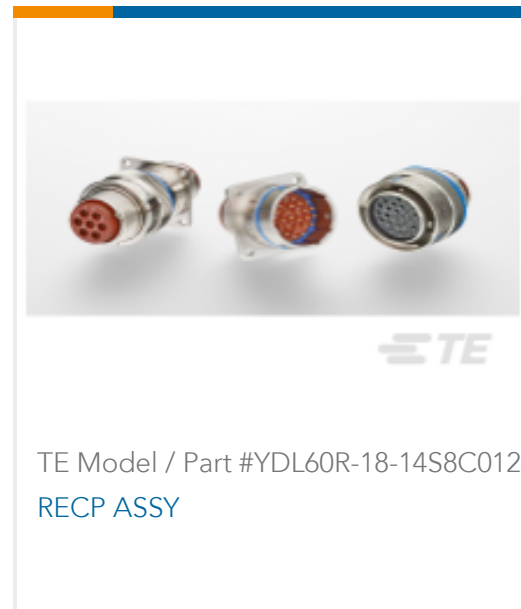
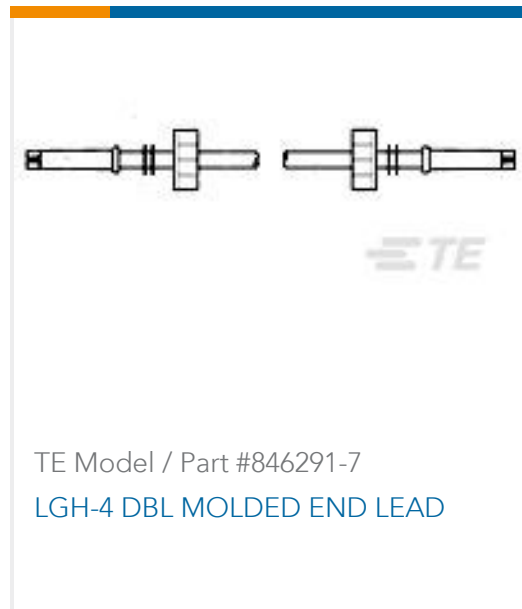
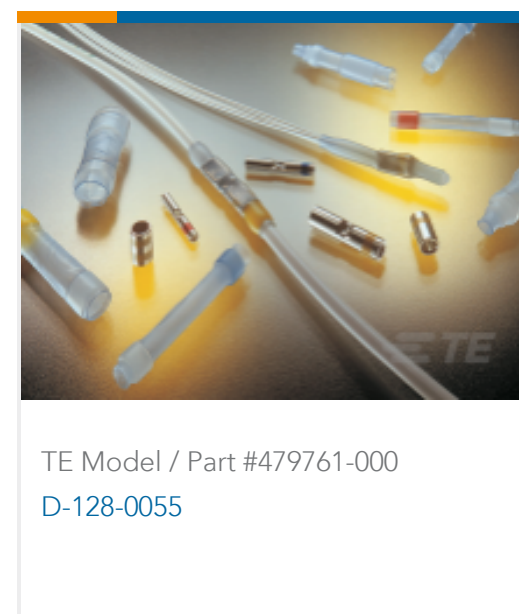
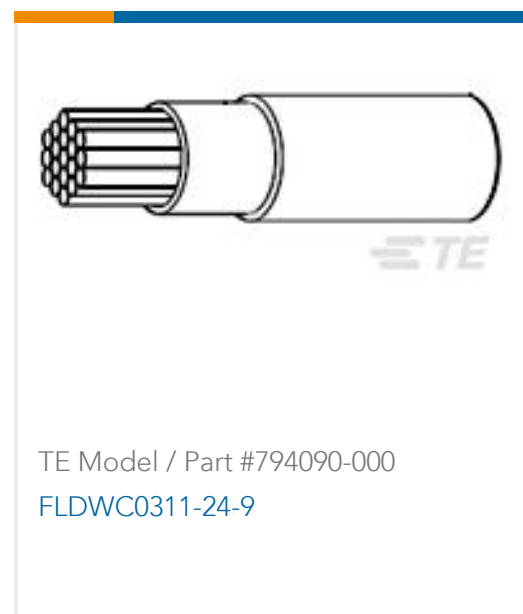

Documents

Product Drawings

7518A1311-0

English

Datasheets & Catalog Pages

1654025_Sec9_CheminaxCables

English

Raychem Cheminax RF Coaxial Cables and RF Connectors Selection Guide

English

Product Specifications

Product Specification

English