

45 W L, S-BAND SINGLE-END POWER GaAs FET

DESCRIPTION

The NES1823S-45 is a 45 W single-end type GaAs FET designed for high power transmitter applications for W-CDMA (IMT-2000) base station systems. It operates at 12 V and is capable of delivering 45 W of output power (CW) with high linear gain, high efficiency and low distortion. Its primary band is 1.8 to 2.3 GHz. The device employs 0.9 μm Tungsten Silicide gates, via holes, plated heatsink, and silicon dioxide passivation for superior performance, thermal characteristics, and reliability.

FEATURES

- Single-end type GaAs FET
- $V_{DS} = 12$ V operation
- High output power: $P_{out} = 45$ W TYP.
- High linear gain : $G_L = 13.5$ dB TYP.
- High power added efficiency: $\eta_{add} = 53\%$ TYP. @ $V_{DS} = 12$ V, $I_{Dset} = 1$ A, $f = 2.17$ GHz
- Hollow plastic package

ORDERING INFORMATION

Part Number	Order Number	Package	Supplying Form
NES1823S-45	NES1823S-45-A	T-142M (Pb-Free)	ESD protective tray

Remark To order evaluation samples, contact your nearby sales office.

Caution Observe precautions when handling because these devices are sensitive to electrostatic discharge.

The information in this document is subject to change without notice. Before using this document, please confirm that this is the latest version.
Not all devices/types available in every country. Please check with local NEC Compound Semiconductor Devices representative for availability and additional information.

ABSOLUTE MAXIMUM RATINGS (T_A = +25°C)

Operation in excess of any one of these parameters may result in permanent damage.

Parameter	Symbol	Ratings	Unit
Drain to Source Voltage	V _{DS}	19	V
Gate to Source Voltage	V _{GSO}	-7	V
Gate to Drain Voltage	V _{GDO}	-26	V
Gate Current	I _G	225	mA
Gain Compression	G _{comp} ^{Note}	3	dB
Total Power Dissipation	P _{tot}	80	W
Channel Temperature	T _{ch}	175	°C
Storage Temperature	T _{stg}	-65 to +150	°C

Note Continuous Wave

RECOMMENDED OPERATING RANGE

Parameter	Symbol	Test Conditions	MIN.	TYP.	MAX.	Unit
Drain to Source Voltage	V _{DS}		-	12	12	V
Channel Temperature	T _{ch}		-	-	+150	°C
Set Drain Current	I _{Dset}	V _{DS} = 12 V, RF OFF	-	1.0	1.5	A
Gate Resistance	R _g		-	2.2	4.8	Ω

ELECTRICAL CHARACTERISTICS (T_A = +25°C)

Parameter	Symbol	Test Conditions	MIN.	TYP.	MAX.	Unit
Pinch-off Voltage	V _p	V _{DS} = 2.5 V, I _{DS} = 162 mA	-0.8	-0.5	-0.2	V
Thermal Resistance	R _{th}	Channel to Case	-	1.0	1.4	°C/W
Output Power	P _{out}	f = 2.17 GHz, V _{DS} = 12 V,	45.5	46.5	-	dBm
Drain Current	I _D	P _{in} = 37.0 dBm, R _g = 2.2 Ω,	-	8.0	-	A
Power Added Efficiency	η _{add}	I _{Dset} = 1 A (RF OFF)	-	53	-	%
Linear Gain	G _L ^{Note}		12.5	13.5	-	dB

Note P_{in} = 25 dBm

TYPICAL CHARACTERISTICS (T_A = +25°C, V_{DS} = 12.0 V, R_g = 2.2 Ω)

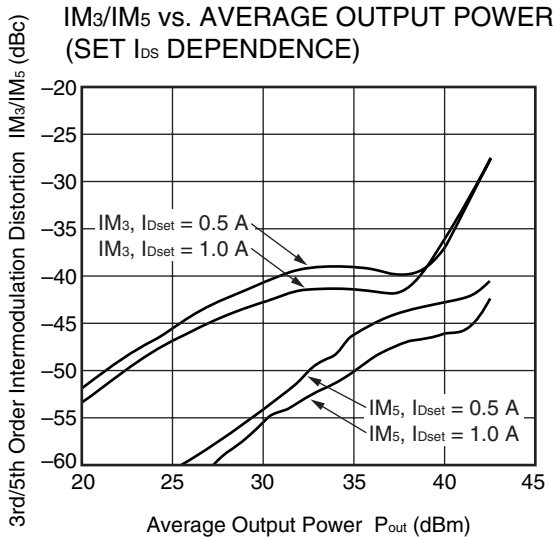
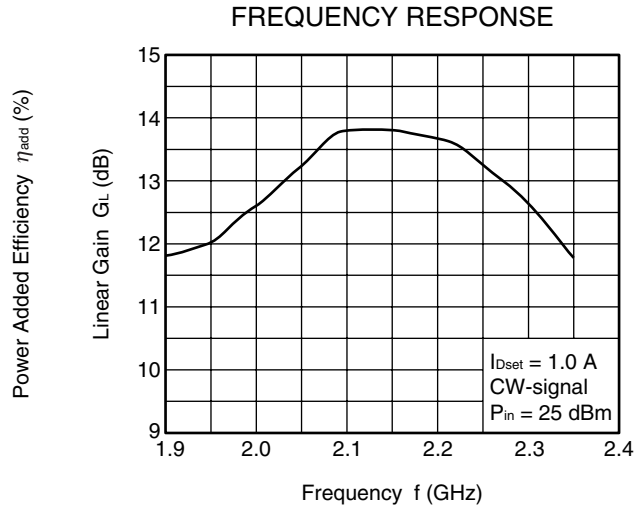
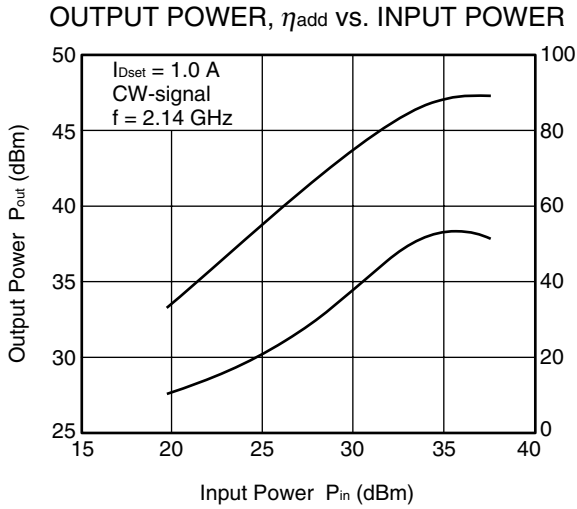

Test Conditions

W-CDMA, 3 GPP test model 1,
64 DPCH, 2 carriers, Clipping 100%,
 $f_1 = 2.135\text{ GHz}$, $f_2 = 2.145\text{ GHz}$ ($\Delta f = 10\text{ MHz}$)

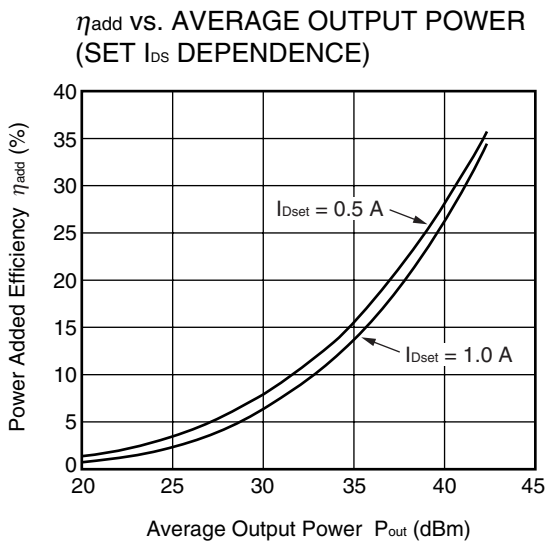
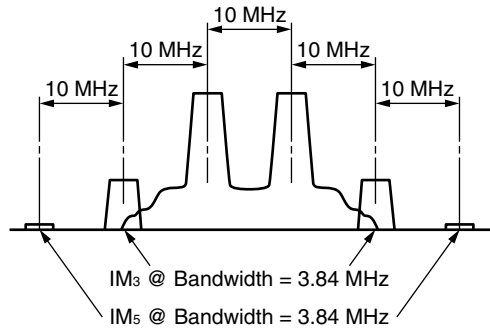

Test Conditions

W-CDMA, 3 GPP test model 1,
64 DPCH, 2 carriers, Clipping 100%,
 $f_1 = 2.135\text{ GHz}$, $f_2 = 2.145\text{ GHz}$ ($\Delta f = 10\text{ MHz}$)

Remark The graphs indicate nominal characteristics.

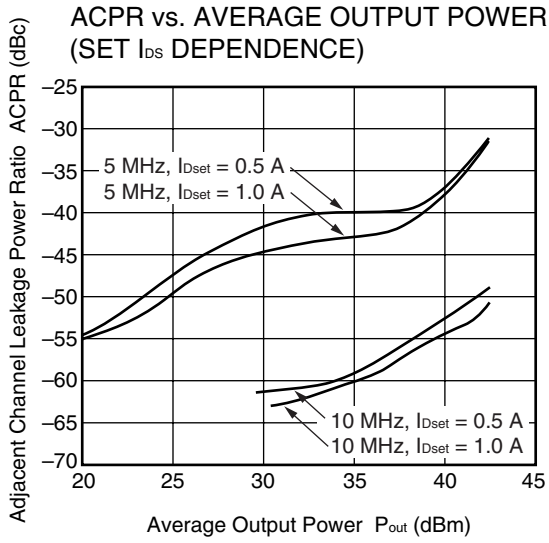

Test Conditions

W-CDMA, 3 GPP test model 1,
64 DPCH, 1 carriers, Clipping 100%,
f = 2.140 GHz

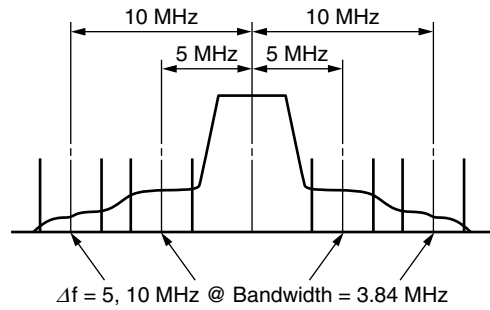

Remark The graphs indicate nominal characteristics.

S-PARAMETERS

S-parameters/Noise parameters are provided on the NEC Compound Semiconductor Devices Web site in a form (S2P) that enables direct import to a microwave circuit simulator without keyboard input.

Click here to download S-parameters.

[RF and Microwave] → [Device Parameters]

URL <http://www.ncsd.necel.com/>

PACKAGE DIMENSIONS

T-142M (UNIT: mm)

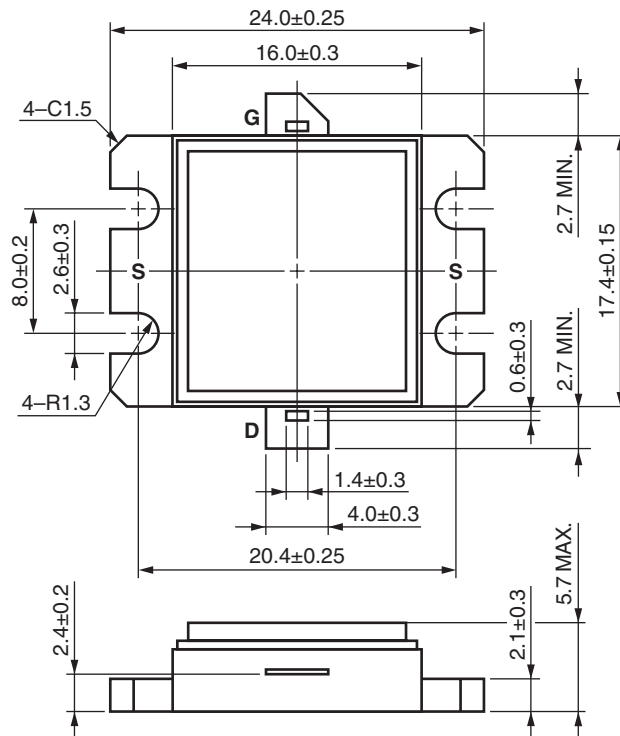

PIN CONNECTIONS

- G : Gate
- S : Source
- D : Drain

NOTES ON CORRECT USE

- (1) Fix to a heatsink or mount surface completely with screws at the four holes of the flange.
- (2) The recommended torque strength of the screws is 29.4 N-cm typical using M2.3 type screws.
- (3) The recommended flatness of the mount surface is less than $\pm 10 \mu\text{m}$ (roughness of surface is $\nabla\nabla\nabla$).

RECOMMENDED SOLDERING CONDITIONS

This product should be soldered and mounted under the following recommended conditions. For soldering methods and conditions other than those recommended below, contact your nearby sales office.

Soldering Method	Soldering Conditions	Condition Symbol
Partial Heating	Peak temperature (terminal temperature) : 350°C or below Soldering time (per terminal of device) : 3 seconds or less Maximum chlorine content of rosin flux (% mass) : 0.2%(Wt.) or below	HS350-P3

Caution Do not use different soldering methods together (except for partial heating).

DEFINIITON OF THERMAL RESISTANCE

This thermal resistance (R_{th} : channel to case) guaranteed in the electrical characteristics shows the value between chip surface and the backside surface of the package.

The thermal resistance between chip surface and mount surface is 0.4 (MAX.) °C/W larger than the thermal resistance value guaranteed in the electrical characteristics, when the package is under the above-mentioned recommendation mounting condition screwed down.

- **The information in this document is current as of October, 2004. The information is subject to change without notice. For actual design-in, refer to the latest publications of NEC's data sheets or data books, etc., for the most up-to-date specifications of NEC semiconductor products. Not all products and/or types are available in every country. Please check with an NEC sales representative for availability and additional information.**
 - No part of this document may be copied or reproduced in any form or by any means without prior written consent of NEC. NEC assumes no responsibility for any errors that may appear in this document.
 - NEC does not assume any liability for infringement of patents, copyrights or other intellectual property rights of third parties by or arising from the use of NEC semiconductor products listed in this document or any other liability arising from the use of such products. No license, express, implied or otherwise, is granted under any patents, copyrights or other intellectual property rights of NEC or others.
 - Descriptions of circuits, software and other related information in this document are provided for illustrative purposes in semiconductor product operation and application examples. The incorporation of these circuits, software and information in the design of customer's equipment shall be done under the full responsibility of customer. NEC assumes no responsibility for any losses incurred by customers or third parties arising from the use of these circuits, software and information.
 - While NEC endeavours to enhance the quality, reliability and safety of NEC semiconductor products, customers agree and acknowledge that the possibility of defects thereof cannot be eliminated entirely. To minimize risks of damage to property or injury (including death) to persons arising from defects in NEC semiconductor products, customers must incorporate sufficient safety measures in their design, such as redundancy, fire-containment, and anti-failure features.
 - NEC semiconductor products are classified into the following three quality grades:
 "Standard", "Special" and "Specific". The "Specific" quality grade applies only to semiconductor products developed based on a customer-designated "quality assurance program" for a specific application. The recommended applications of a semiconductor product depend on its quality grade, as indicated below. Customers must check the quality grade of each semiconductor product before using it in a particular application.
 "Standard": Computers, office equipment, communications equipment, test and measurement equipment, audio and visual equipment, home electronic appliances, machine tools, personal electronic equipment and industrial robots
 "Special": Transportation equipment (automobiles, trains, ships, etc.), traffic control systems, anti-disaster systems, anti-crime systems, safety equipment and medical equipment (not specifically designed for life support)
 "Specific": Aircraft, aerospace equipment, submersible repeaters, nuclear reactor control systems, life support systems and medical equipment for life support, etc.
- The quality grade of NEC semiconductor products is "Standard" unless otherwise expressly specified in NEC's data sheets or data books, etc. If customers wish to use NEC semiconductor products in applications not intended by NEC, they must contact an NEC sales representative in advance to determine NEC's willingness to support a given application.
- (Note)
- (1) "NEC" as used in this statement means NEC Corporation, NEC Compound Semiconductor Devices, Ltd. and also includes its majority-owned subsidiaries.
 - (2) "NEC semiconductor products" means any semiconductor product developed or manufactured by or for NEC (as defined above).

M8E 00.4-0110

<p>Caution</p>	<p>GaAs Products</p>	<p>This product uses gallium arsenide (GaAs). GaAs vapor and powder are hazardous to human health if inhaled or ingested, so please observe the following points.</p> <ul style="list-style-type: none"> • Follow related laws and ordinances when disposing of the product. If there are no applicable laws and/or ordinances, dispose of the product as recommended below. <ol style="list-style-type: none"> 1. Commission a disposal company able to (with a license to) collect, transport and dispose of materials that contain arsenic and other such industrial waste materials. 2. Exclude the product from general industrial waste and household garbage, and ensure that the product is controlled (as industrial waste subject to special control) up until final disposal. • Do not burn, destroy, cut, crush, or chemically dissolve the product. • Do not lick the product or in any way allow it to enter the mouth.
-----------------------	----------------------	---

► For further information, please contact

NEC Compound Semiconductor Devices, Ltd. <http://www.ncsd.necel.com/>

E-mail: salesinfo@ml.ncsd.necel.com (sales and general)

techinfo@ml.ncsd.necel.com (technical)

Sales Division TEL: +81-44-435-1588 FAX: +81-44-435-1579

NEC Compound Semiconductor Devices Hong Kong Limited

E-mail: ncsd-hk@elhk.nec.com.hk (sales, technical and general)

Hong Kong Head Office TEL: +852-3107-7303 FAX: +852-3107-7309

Taipei Branch Office TEL: +886-2-8712-0478 FAX: +886-2-2545-3859

Korea Branch Office TEL: +82-2-558-2120 FAX: +82-2-558-5209

NEC Electronics (Europe) GmbH <http://www.ee.nec.de/>

TEL: +49-211-6503-0 FAX: +49-211-6503-1327

California Eastern Laboratories, Inc. <http://www.cel.com/>

TEL: +1-408-988-3500 FAX: +1-408-988-0279