

300mW, NPN Small Signal Transistor

FEATURES

- Low power loss, high efficiency
- Ideal for automated placement
- High surge current capability
- Moisture sensitivity level: level 1, per J-STD-020
- RoHS Compliant
- Halogen-free according to IEC 61249-2-21

APPLICATIONS

- Switching mode power supply (SMPS)
- Adapters
- Lighting application
- On-board DC/DC converter

MECHANICAL DATA

- Case: SOT-23
- Molding compound meets UL 94 V-0 flammability rating
- Terminal: Matte tin plated leads, solderable per J-STD-002
- Meet JESD 201 class 1A whisker test
- Weight: 8 mg (approximately)

KEY PARAMETERS		
PARAMETER	VALUE	UNIT
V_{CBO}	60	V
V_{CEO}	40	V
V_{EBO}	6	V
I_C	200	mA
h_{FE}	400	
Package	SOT-23	
Configuration	Single die	

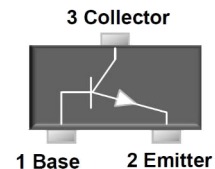

ABSOLUTE MAXIMUM RATINGS ($T_A = 25^\circ\text{C}$ unless otherwise noted)			
PARAMETER	SYMBOL	MMBT3904	UNIT
Marking code on the device		1AM	
Collector-base voltage	V_{CBO}	60	V
Collector-emitter voltage	V_{CEO}	40	V
Emitter-base voltage	V_{EBO}	6	V
Collector current	I_C	200	mA
Power dissipation	P_D	300	mW
Junction temperature	T_J	-55 to +150	$^\circ\text{C}$
Storage temperature	T_{STG}	-55 to +150	$^\circ\text{C}$

ELECTRICAL SPECIFICATIONS ($T_A = 25^\circ\text{C}$ unless otherwise noted)						
PARAMETER	CONDITIONS	SYMBOL	MIN	TYP	MAX	UNIT
Collector-base breakdown voltage	$I_C = 10\ \mu\text{A}, I_E = 0$	$V_{(BR)CBO}$	60	-	-	V
Collector-emitter breakdown voltage	$I_C = 1\ \text{mA}, I_B = 0$	$V_{(BR)CEO}$	40	-	-	V
Emitter-base breakdown voltage	$I_E = 10\ \mu\text{A}, I_C = 0$	$V_{(BR)EBO}$	6	-	-	V
Collector cutoff current	$V_{CB} = 60\ \text{V}, I_E = 0$	I_{CBO}	-	-	0.1	μA
Collector cutoff current	$V_{CE} = 30\ \text{V}, V_{BE(OFF)} = 3\ \text{V}$	I_{CEO}	-	-	50	nA
Emitter cutoff current	$V_{EB} = 5\ \text{V}, I_C = 0$	I_{EBO}	-	-	0.1	μA
DC current gain	$V_{CE} = 1\ \text{V}, I_C = 10\ \text{mA}$	h_{FE}	100	-	400	
	$V_{CE} = 1\ \text{V}, I_C = 50\ \text{mA}$		60	-	-	
	$V_{CE} = 1\ \text{V}, I_C = 100\ \text{mA}$		30	-	-	
Collector-emitter saturation voltage	$I_C = 50\ \text{mA}, I_B = 5\ \text{mA}$	$V_{CE(sat)}$	-	-	0.30	V
Base-emitter saturation voltage	$I_C = 50\ \text{mA}, I_B = 5\ \text{mA}$	$V_{BE(sat)}$	-	-	0.95	V
Transition frequency	$V_{CE} = 20\ \text{V}, I_C = 10\ \text{mA}, f = 100\ \text{MHz}$	f_T	250	-	-	MHz
Delay time	$V_{CC} = 3\ \text{V}, V_{BE} = 0.5\ \text{V}, I_C = 10\ \text{mA}, I_{B1} = 1\ \text{mA}$	t_d	-	-	35	ns
Rise time		t_r	-	-	35	ns
Storage time	$V_{CC} = 3\ \text{V}, I_{B1} = I_{B2} = 1\ \text{mA}, I_C = 10\ \text{mA}$	t_s	-	-	200	ns
Fall time		t_f	-	-	50	ns

ORDERING INFORMATION		
ORDERING CODE	PACKAGE	PACKING
MMBT3904 RF	SOT-23	3K / 7" Reel
MMBT3904 RFG	SOT-23	3K / 7" Reel
MMBT3904 R5	SOT-23	10K / 13" Reel
MMBT3904 R5G	SOT-23	10K / 13" Reel
MMBT3904-D0 RF	SOT-23	3K / 7" Reel
MMBT3904-D0 RFG	SOT-23	3K / 7" Reel
MMBT3904-D0 R5	SOT-23	10K / 13" Reel
MMBT3904-D0 R5G	SOT-23	10K / 13" Reel
MMBT3904-B0 RF	SOT-23	3K / 7" Reel
MMBT3904-B0 RFG	SOT-23	3K / 7" Reel
MMBT3904-B0 R5	SOT-23	10K / 13" Reel
MMBT3904-B0 R5G	SOT-23	10K / 13" Reel

CHARACTERISTICS CURVES

($T_A = 25^\circ\text{C}$ unless otherwise noted)

Fig. 1 Typical Pulsed Current Gain VS. Collector Current

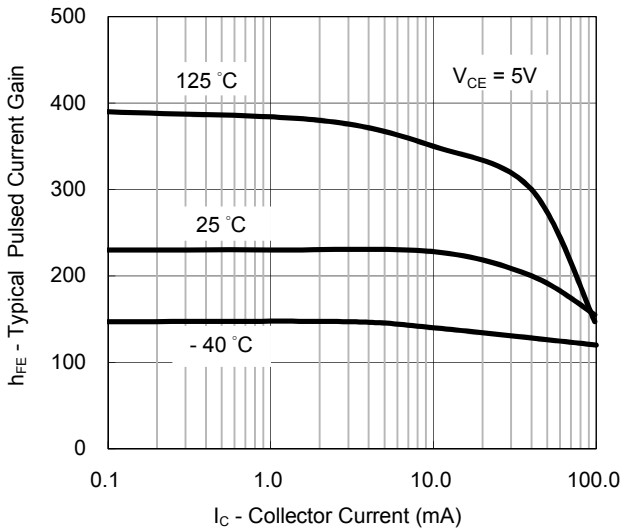

Fig.2 Collector-Emitter Saturation Voltage VS. Collector Current

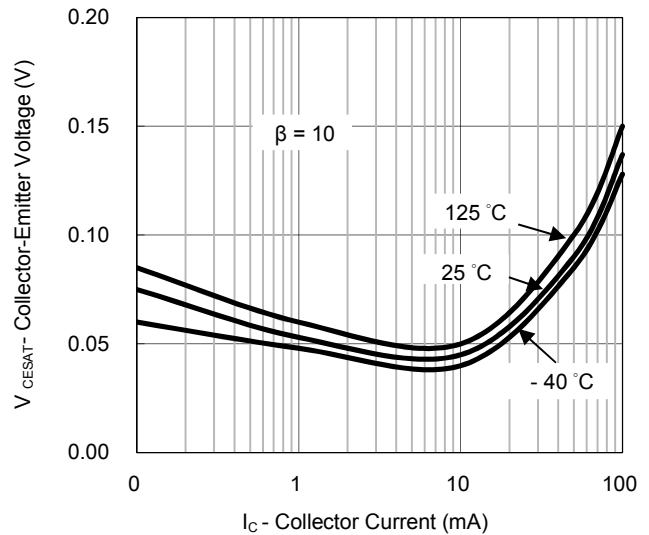

Fig.3 Base-Emitter Saturation Voltage VS. Collector Current

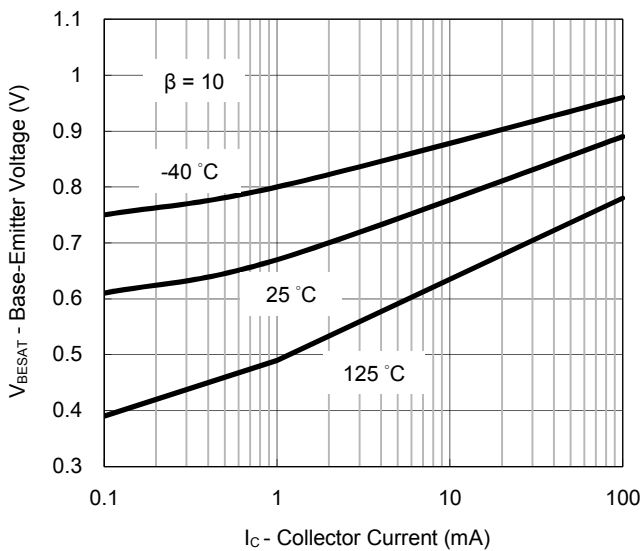
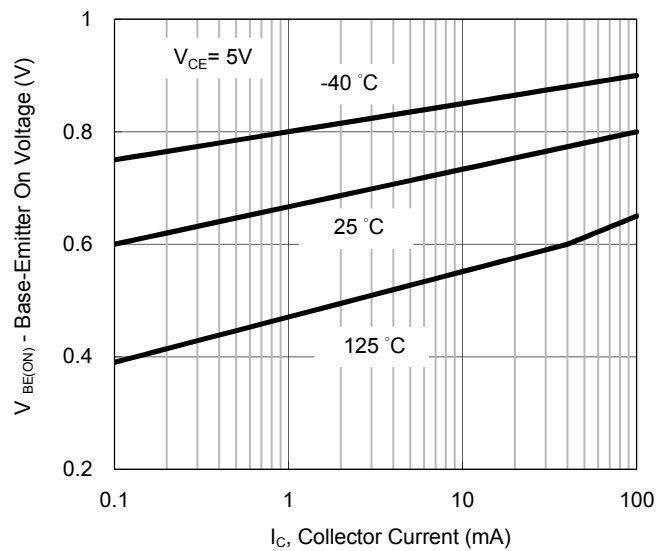

Fig.4 Base-Emitter On Voltage VS. Collector Current



CHARACTERISTICS CURVES

($T_A = 25^\circ\text{C}$ unless otherwise noted)

Fig. 5 Collector-Cutoff Current VS. Ambient Temperature

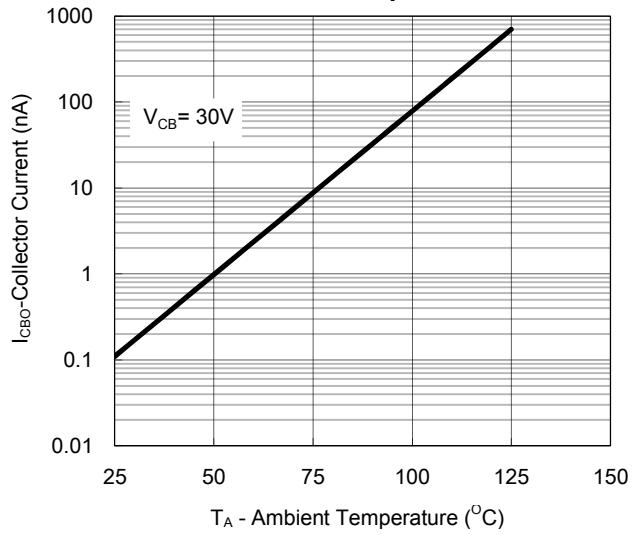
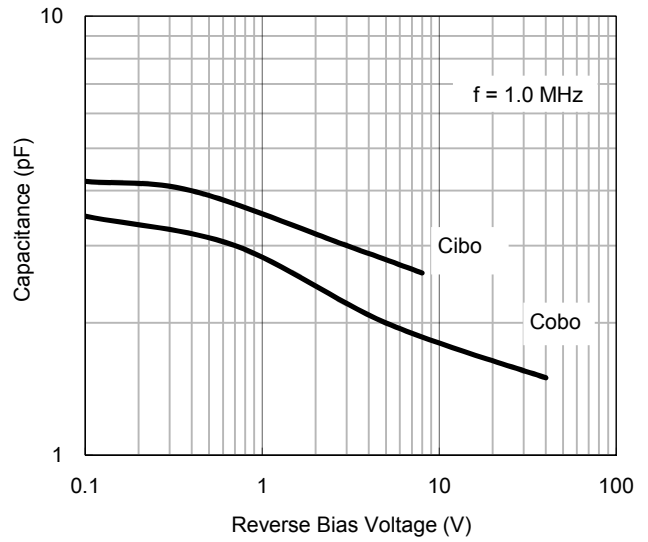
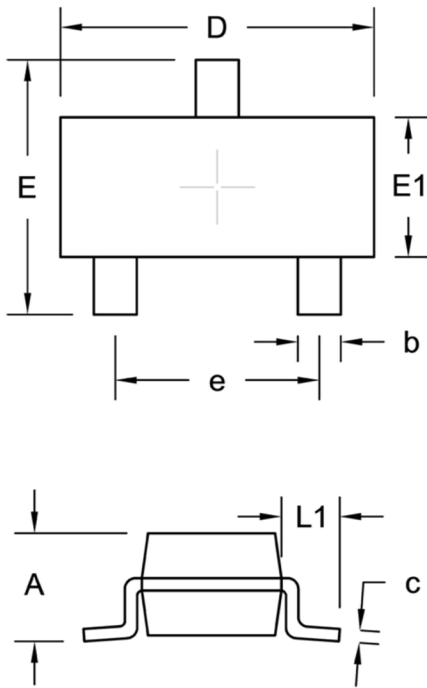

Fig. 6 Capacitance VS. Reverse Bias Voltage



PACKAGE OUTLINE DIMENSION

SOT-23



DIM.	Unit (mm)		Unit (inch)	
	Min.	Max.	Min.	Max.
A	0.89	1.12	0.035	0.044
b	0.30	0.50	0.012	0.020
c	0.08	0.20	0.003	0.008
D	2.80	3.04	0.110	0.120
E	2.10	2.64	0.083	0.104
E1	1.20	1.40	0.047	0.055
e	1.90 BSC		0.075 BSC	
L1	0.54 REF.		0.021 REF.	

SUGGESTED PAD LAYOUT

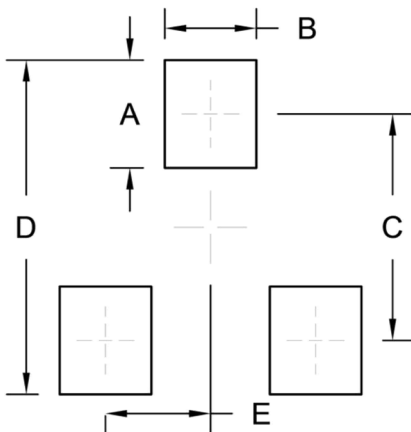

Symbol	Unit (mm)	Unit (inch)
A	1.00	0.039
B	0.85	0.033
C	2.10	0.083
D	3.10	0.122
E	0.98	0.039

Notice

Specifications of the products displayed herein are subject to change without notice. TSC or anyone on its behalf, assumes no responsibility or liability for any errors or inaccuracies.

Purchasers are solely responsible for the choice, selection, and use of TSC products and TSC assumes no liability for application assistance or the design of Purchasers' products.

Information contained herein is intended to provide a product description only. No license, express or implied, to any intellectual property rights is granted by this document. Except as provided in TSC's terms and conditions of sale for such products, TSC assumes no liability whatsoever, and disclaims any express or implied warranty, relating to sale and/or use of TSC products including liability or warranties relating to fitness for a particular purpose, merchantability, or infringement of any patent, copyright, or other intellectual property right.

The products shown herein are not designed for use in medical, life-saving, or life-sustaining applications. Customers using or selling these products for use in such applications do so at their own risk and agree to fully indemnify TSC for any damages resulting from such improper use or sale.