



Helping Customers Innovate, Improve & Grow



VX-501

Features

- AT-Cut Crystal
- Surface Mount FR4 based package
- Reflow Process Compatible
- Low Phase Noise
- Tight Stabilities
- Frequency Range 1 - 800MHz
- Standard Frequencies 2.048; 10; 16,384; 30,72; 32,768; 38,88; 44.8;
- 52; 61.44; 68.736; 76.8; 77.76; 81.92; 92.16;
- 100; 112; 122.88; 125; 134.4; 153.6; 155.52;
- 160; 179.2; 184.32; 245.76; 312.5; 320;
- 368.64; 400; 448; 471.8592; 491.52; 622.08;
- 672; 737.28; 800MHz
- Previous Model Number: C5310

Applications

- Base Stations
- Test Equipment
- Synthesizers
- Switching

Performance Specifications

Frequency Stabilities ¹					
Parameter	Min	Typical	Max	Units	Condition
vs. operating temperature range (referenced to +25°C)	-15		+15	ppm	-20 to +70°C
Initial tolerance	-10		+10	ppm	@V _c =V _s /2 V _s ±5% Load ±10%
vs. supply voltage change	-3		+3	ppm	
vs. load change	-1		+1	ppm	
vs. aging / 1 Year	-3		+3	ppm	
vs. aging (following years)	-1		+1	ppm	
vs. operating temperature range (referenced to +25°C)	-30		+30	ppm	-40 to +85°C
Initial tolerance	-15		+15	ppm	@V _c =V _s /2 V _s ±5% Load ±10%
vs. supply voltage change	-3		+3	ppm	
vs. load change	-2		+2	ppm	
vs. aging / 1 Year	-3		+3	ppm	
vs. aging (following years)	-1		+1	ppm	

Performance Specifications

Supply Voltage (Vs)							
Parameter	Min	Typical	Max	Units	Condition		
Supply voltage (standard)	3.135	3.3	3.465	VDC	Options		
Current consumption			40	mA			@ HCMOS, Sinewave
Current consumption			90	mA			@ PECL, LVDS
Supply voltage	4.75	5	5.25	VDC			
Current consumption			30	mA			@ HCMOS, Sinewave
Current consumption			80	mA			@ PECL, LVDS
RF Output							
Signal	HCMOS				Options		
Load		15		pF			
Rise and Fall time			5	ns			@ 15 pF 10 to 90%
Duty cycle	40		60	%			@ Vs / 2
Signal	PECL						
Load		50		Ω			
Rise and Fall time			1	ns	20 to 80%		
Duty cycle	45		55	%			
Signal	LVDS						
Load		100		Ω			
Rise and Fall time			1	ns	10 to 90%		
Duty cycle	40		60	%			
Signal	Sinewave						
Load		50		Ω			
Output Power	-3	0	3	dBm			
Frequency Tuning (EFC)							
Tuning Range	±75.0	±90	±200.0				
Linearity	10 %						
Tuning Slope	Positive						
Control Voltage Range	0 0.5	1.65 2.5	3.3 4.5	VDC VDC	with Vs = 3.3V with Vs = 5V		
Frequency Control Input Impedance	10			kΩ			
Additional Parameters							
Phase Noise		-85 -115 -138 -153 -155		dBc/Hz dBc/Hz dBc/Hz dBc/Hz dBc/Hz	10 Hz 100 Hz 1 kHz 10 kHz 100 kHz	@52MHz HCMOS 3.3V	
Jitter		0.2		ps RMS	@ 12kHz .. 20MHz		
Phase Noise		-80 -105 -135 -143 -145		dBc/Hz dBc/Hz dBc/Hz dBc/Hz dBc/Hz	10 Hz 100 Hz 1 kHz 10 kHz 100 kHz	@ 155.52 MHz PECL 3.3V	
Jitter		0.6		ps RMS	@ 12kHz .. 20MHz		
Phase Noise		-80 -112 -130 -150 -155		dBc/Hz dBc/Hz dBc/Hz dBc/Hz dBc/Hz	10 Hz 100 Hz 1 kHz 10 kHz 100 kHz	@ 155.52 MHz LVDS 3.3V	
Jitter		0.2		ps RMS	@ 12kHz .. 20MHz		
Phase Noise		-55 -85 -115 -140 -150		dBc/Hz dBc/Hz dBc/Hz dBc/Hz dBc/Hz	10 Hz 100 Hz 1 kHz 10 kHz 100 kHz	@ 622.08 MHz PECL 3.3V	
Jitter		0.1		ps RMS	@ 12kHz .. 20MHz		

Performance Specifications

Additional Parameters

Subharmonics		-40	dBc	For > 160 MHz only	
Weight		2.0 g			
Processing & Packing	Handling & Processing Note				
Absolute Maximum Ratings					
Supply voltage (Vs)		6.0	V		
Operable Temperature Range	-40	+85	°C		
Storage Temperature Range	-55	+125	°C		

Typical Phase Noise and Jitter

Phase Noise

VX-501 @ 52 MHz HCMOS

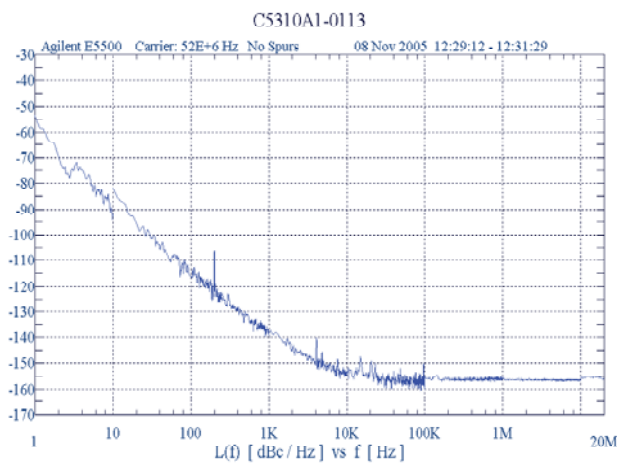

Phase Noise

VX-501 @ 155.52 MHz LVPECL

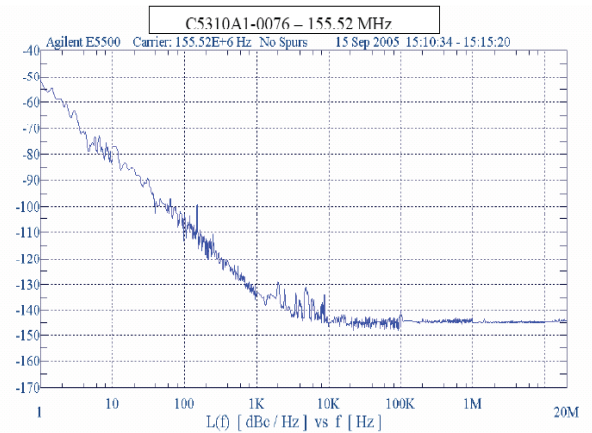

Phase Noise

VX-501 @ 155.52 MHz LVDS

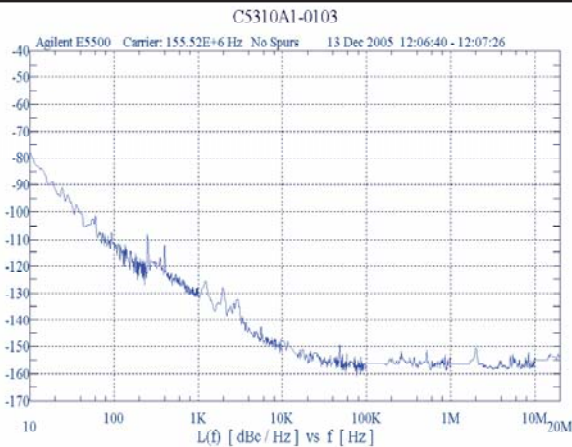

Phase Noise

VX-501 @ 622.08 MHz LVPECL

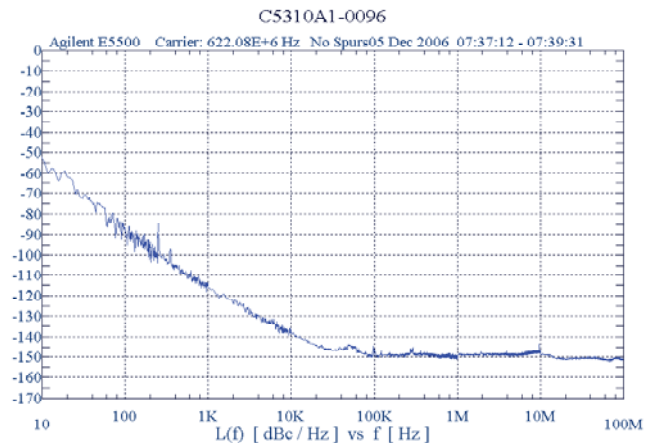

Enclosure

Package Codes

Type	Height "H"	Pin Length "L"
G223B	5.9	NA

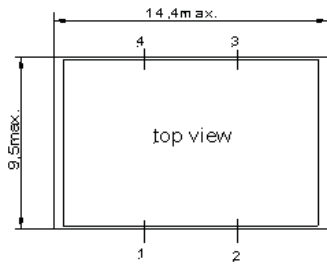

G 223

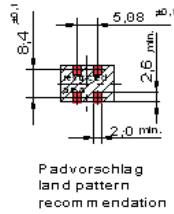
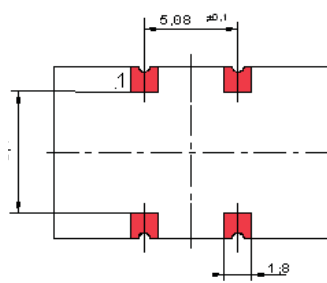
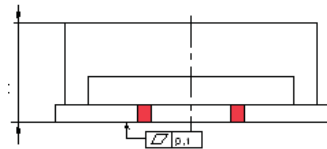

Package Codes

Type	Height "H"
G218B	5.9

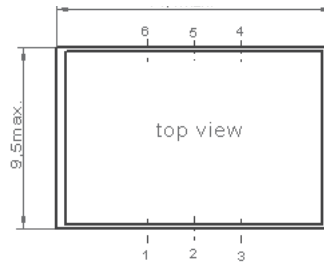

G 218

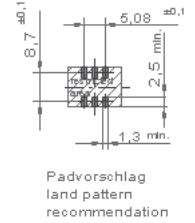
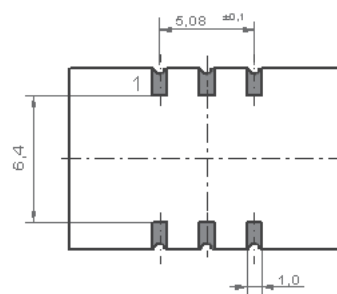
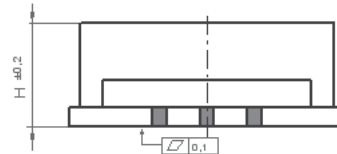

Pin Connections

1	Control Voltage (Vc)
2	Ground
3	RF Output
4	Supply Voltage Input (Vs)

Pin Connections

1	Control Voltage (Vc)
2	N.C. / Enable (Option)
3	Ground
4	RF Output
5	RF Output complementary (PECL / LVDS) N.C. (CMOS)
6	Supply Voltage Input (Vs)

Marking

VX-501-xxxx
Frequency
● AYYWW

Enable true table (optional)

	HCMOS		LVPECL / LVDS	
	Pin 4	Pin 5	Pin 4	Pin 5
Pin 2	Pin 4	Pin 5	Pin 4	Pin 5
High	Data	N.C.	No Data	No Data
Open	Data	N.C.	Data	Compl. Data
Low	High Tristate	N.C.	Data	Compl. Data

Standard Shipping Method

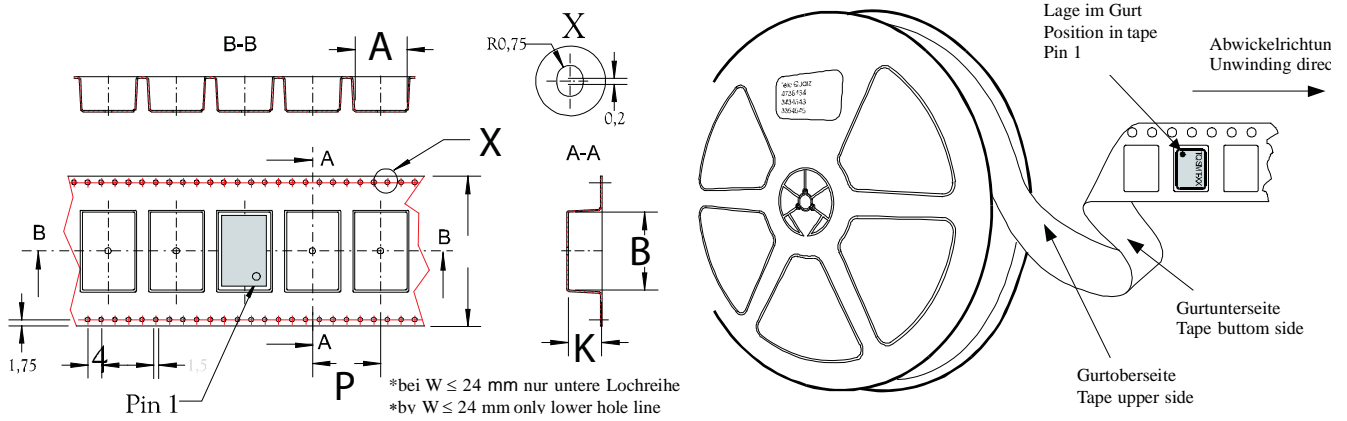

Enclosure Type	Tape Width W (mm)	Quantity per meter	Quantity per reel	Dimension P
G218B/G223B	24	83.3	850	12

Recommended Reflow Profile

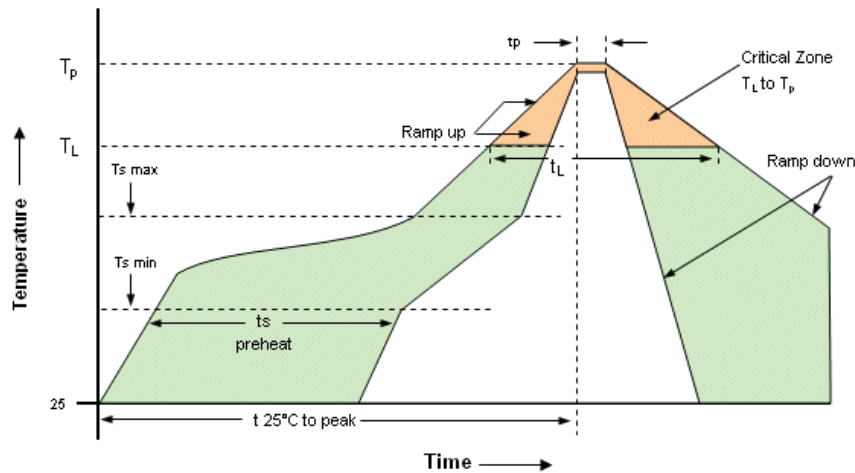

Profile Feature	Pb-Free Assembly/ Sn-Pb Assembly	Profile Feature	Pb-Free Assembly/ Sn-Pb Assembly
Average ramp-up rate (T_L to T_p)	3°C/second max.	Time 25°C to Peak Temperature	8 minutes max.
Preheat -Temperature Min T_{Smin} -Temperature Min T_{Smax} -Time (min to max) t_s	150°C 200°C 60-180 seconds	Time maintained above -Temperature (T_L) -Time (t_L)	217°C 60-150 seconds
T_{Smax} to T_L -Ramp-up Rate	3°C/second max		
Time maintained above -Temperature (T_L) -Time (t_L)	217°C 60-150 seconds	Time within 5°C of actual Peak Temperature (t_p)	20-40 seconds
Peak Temperature (T_p)	max 260°C	Ramp-down Rate	6°C/ second max

Note: All temperatures refer to topside of the package, measured on the package body surface.

Ordering Information

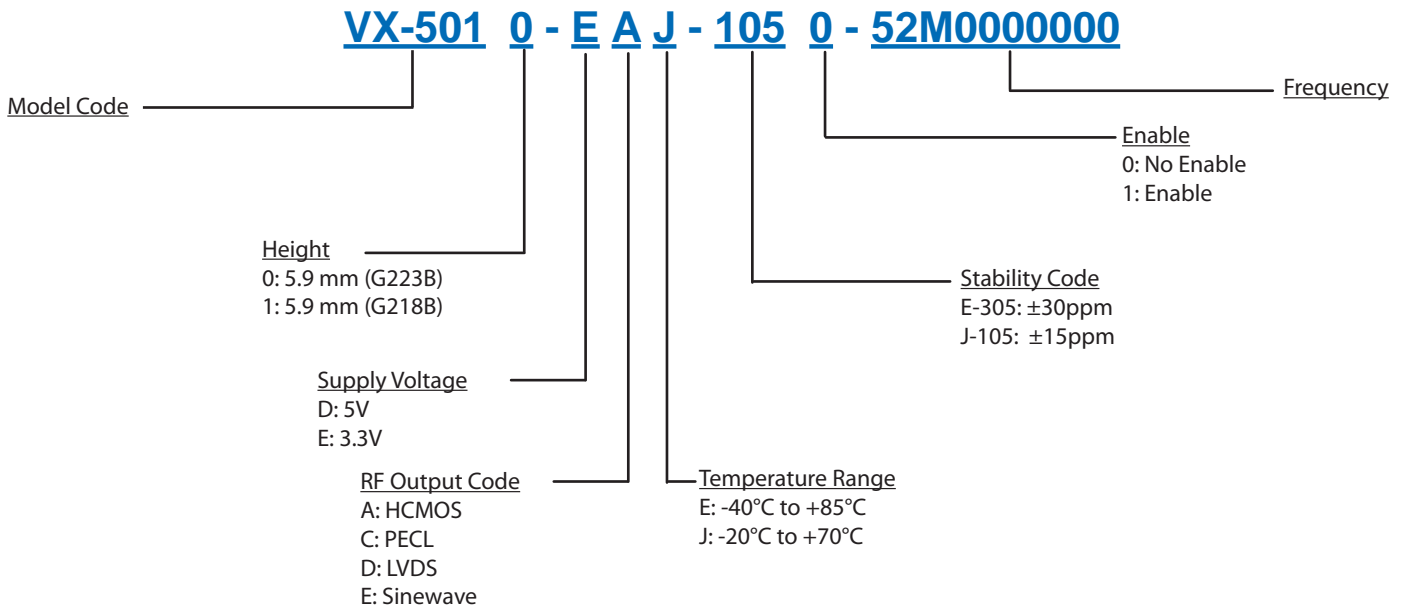

Notes:

1. Contact factory for improved stabilities or additional product options. Not all options and codes are available at all frequencies.
2. Unless other stated all values are valid after warm-up time and refer to typical conditions for supply voltage, frequency control voltage, load, temperature (25°C).
3. Phase noise degrades with increasing output frequency.
4. Subject to technical modification.
5. Contact factory for availability.

For Additional Information, Please Contact

USA:

Vectron International
267 Lowell Road
Hudson, NH 03051
Tel: 1.888.328.7661
Fax: 1.888.329.8328

Europe:

Vectron International
Landstrasse, D-74924
Neckarbischofsheim, Germany
Tel: +49 (0) 7268-801-0
Fax: +49 (0) 7268-801-281

Asia:

Vectron International
1F-2F, No 8 Workshop, No 308 Fenju Road
WaiGaoQiao Free Trade Zone
Pudong, Shanghai, China 200131
Tel: 86.21.5048.0777
Fax: 86.21.5048.1881

Disclaimer

Vectron International reserves the right to make changes to the product(s) and or information contained herein without notice. No liability is assumed as a result of their use or application. No rights under any patent accompany the sale of any such product(s) or information.

Rev: 8/2008