

OKI Semiconductor

MSM6378A/MSM6379

OTP ROM Built-in Voice Synthesis IC

GENERAL DESCRIPTION

The MSM6378A/6379 is an ADPCM voice synthesis IC with a built-in one-time programmable (OTP) ROM. The MSM6378A/6379 reproduces the voice data, which the user has analyzed and recorded using the "ANAWRITER" for an exclusive use, through a speaker driving AMP and speaker. The MSM6378A/6379 can be used in voice cards, small-quantity multi-product toy line-ups, and personal use devices.

FEATURES

- MSM6379 : Built-in 512Kbit OTP ROM (500Kbits for recording)
- MSM6378A : Built-in 256Kbit OTP ROM (244Kbits for recording)
- 4-bit straight ADPCM method
- Built-in low pass filter
- Built-in 12-bit DA converter
- Data write time : MSM6379 16 sec
MSM6378A 8 sec
- Oscillation system : R/C oscillation or external clock input
(ceramic oscillation is available.)
- Oscillation frequency : 64 to 256kHz
- Sampling frequency : 4 to 16kHz (original oscillation frequency/16)
- Activation : Power on start or reactivation after one shot output
- Voice output : one-shot or repeat
- Low current consumption
- Largest voice time : MSM6379 32.0 sec (4kHz sampling)
MSM6378A 15.6 sec (4kHz sampling)
- Number of phrases that can be output : One phrase only
- Power supply voltage : DAO pin 2.4 to 5.5V
AOUT pin 2.7 to 5.5V ($f_{SAM} \leq 8kHz$)
3.5 to 5.5V ($f_{SAM} \geq 10kHz$)
- Package : 16-pin plastic DIP (DIP16-P-300-W1)
(Product name: MSM6378ARS/MSM6379RS)
Chip

	M6378A	M6379
ANAWRITER MK2	○	×
ANAWRITER MK6	○	○
AR761/AR762	○	○
AR76-202/AR203	○	○

BLOCK DIAGRAM

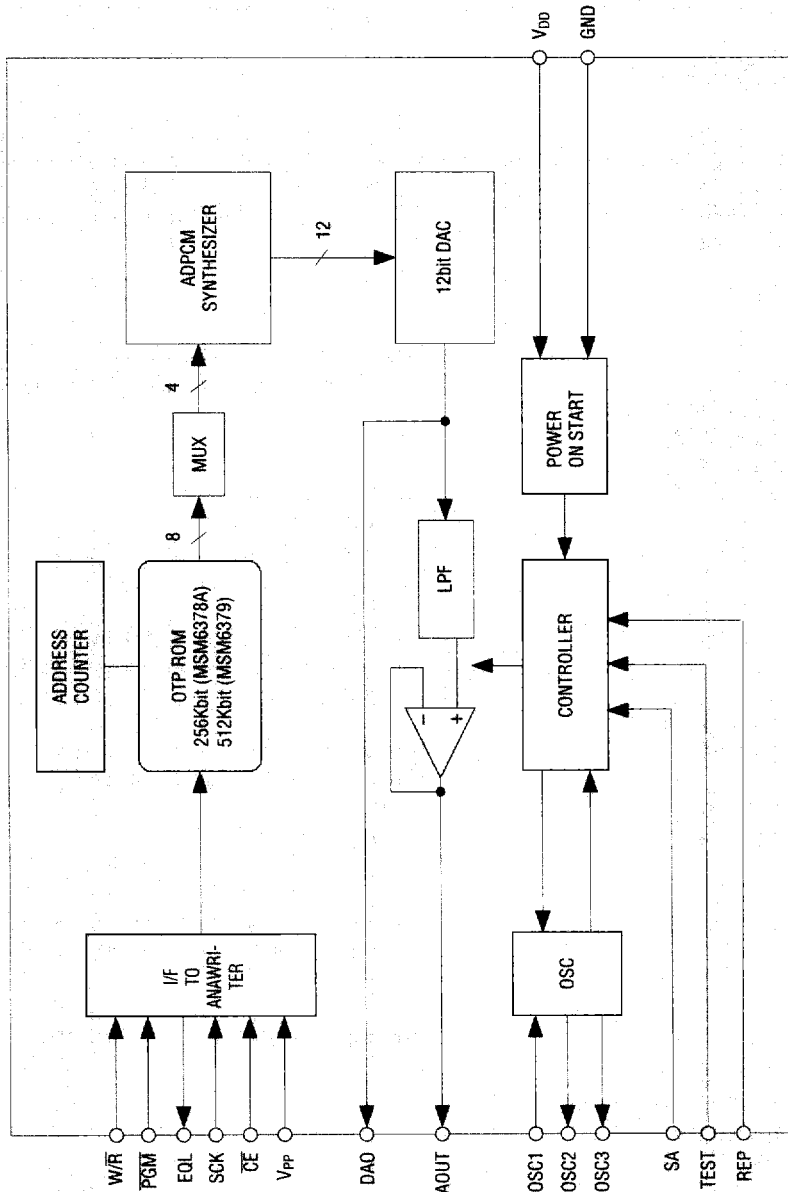

PIN CONFIGURATION (TOP VIEW)

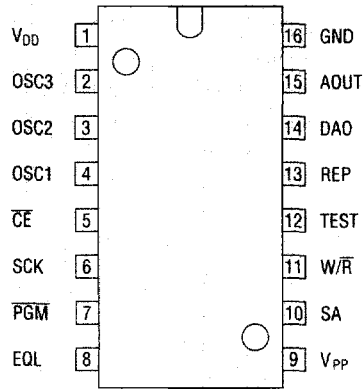

16-Pin Plastic DIP

PIN DESCRIPTION

Symbol	Type	Description
REP	I	Repeat/one-shot selection pin. In power-on or input to SA pin, one-shot is output when REP="L" and repeated voices are output when REP="H". The voice is not output so long as this pin is merely set to "H" level. This pin does not include a pull-down resistor.
SA	I	Pin to be reactivated after one-shot output. When a single pulse is applied to SA pin, the IC is reactivated on the falling edge. This pin includes a pull-down resistor.
W/ \bar{R}	I	Interface pin for the ANAWRITER for exclusive use. Set to "L" or "open" in playback. This pin includes a pull-down resistor.
PGM	I	Same as above (W/ \bar{R}).
SCK	I	Same as above (W/ \bar{R}).
\bar{CE}	I	Same as above (W/ \bar{R}).
EQL	O	Interface pin for the ANAWRITER for exclusive use. Set to "open" in playback.
TEST	I	Internal circuit test pin. Set to "L" or "open" in playback. This pin includes a pull-down resistor.
OSC1	I	Oscillation RC connection pin or external clock input pin.
OSC2	O	Oscillation RC connection pin. Set to open to input external clock through the OSC1 pin.
OSC3	O	Same as above (OSC2).
DAO	O	DA converter output pin.
AOUT	O	LPF output pin.
V _{PP}	—	Power voltage pin for writing to the built-in OTP. Set to V _{PP} = V _{DD} or "open" in playback.
V _{DD}	—	Power pin. Insert a bypass capacitor of 0.1 μ F or more between this pin and the GND pin.
GND	—	Ground pin.

ABSOLUTE MAXIMUM RATINGS

Parameter	Symbol	Condition	Rating	Unit
Power Supply Voltage	V _{DD}	T _a = 25°C	-0.3 to +7.0	V
Input Voltage	V _{IN}	T _a = 25°C	-0.3 to V _{DD} +0.3	V
Storage Temperature	T _{STG}	—	-55 to +125	°C

RECOMMENDED OPERATING CONDITIONS

Parameter	Symbol	Condition	Range	Unit
Power Supply Voltage	V _{DD}	GND = 0V	DAO pin 2.4 to 5.5 AOUT pin 2.7 to 5.5 (f _S ≤ 8 kHz) 3.5 to 5.5 (f _S ≥ 10 kHz)	V
Operating Temperature	T _{op}	—	-10 to +70	°C
Oscillation Frequency	f _{OSC}	—	64 to 256	kHz

ELECTRICAL CHARACTERISTICS (V_{PP}=V_{DD} at playback)

DC Characteristics

(V_{DD}=4.5 to 5.5V, GND=0V, T_a=0 to +70°C)

Parameter	Symbol	Condition	Min	Typ	Max	Unit
"H" Input Voltage	V _{IH}	—	0.8×V _{DD}	—	V _{DD} +0.1	V
"L" Input Voltage	V _{IL}	—	-0.1	—	0.2×V _{DD}	V
"H" Input Current 1	I _{IH1}	Applies to \overline{CE} , SCK, \overline{PGM} , SA, W/R, and TEST pins	20	—	400	μA
"H" Input Current 2	I _{IH2}	Applies to OSC1 and REP pins	—	—	10	μA
"L" Input Current	I _{IL}	—	-10	—	—	μA
Operation Current Consumption	I _{DD}	—	—	7	20	mA
Standby Current Consumption	I _{DS}	—	—	0.1	10	μA
DA Output Relative Accuracy	V _{DAE}	No load	—	—	40	mV
DA Output Impedance	R _{DAO}	—	15	25	35	kΩ
LPF Minimum Driving Resistance	R _{AOUT}	—	50	—	—	kΩ

AC Characteristics

(V_{DD}=4.5 to 5.5V, GND=0V, T_a=0 to +70°C)

Parameter	Symbol	Condition	Min	Typ	Max	Unit
Oscillation Duty Cycle	f _{duty}	—	40	50	60	%
Sampling Frequency	f _S	f _{OSC} /16	4	—	16	kHz
Oscillation Stabilization Time	f _{OSC}	32/f _{OSC}	128	—	512	ms
Upper Offset Time	t _{OFU}	1K/f _{SAM}	64	—	256	ms
Lower Offset Time	t _{OFL}	2K/f _{SAM}	128	—	512	ms
MSM6378A Voice Output Time	t _{OUT1}	244Kbit/(4bit×f _{SAM})	3.9	—	15.6	sec
MSM6379 Voice Output Time	t _{OUT2}	500Kbit/(4bit×f _{SAM})	8.0	—	32.0	sec
SA Input Pulse Width	t _{SA}	—	10	—	—	μs
MSM6378A Data Write Time	t _{WR1}	*Use ANAWRITER	—	8	—	sec
MSM6379 Data Write Time	t _{WR2}	*Use ANAWRITER	—	16	—	sec

- * The MSM6378A/6379 ensures only writing by the ANAWRITER, PARAWRITER or voice analysis editing tools (AR76-202 and AR203). ANAWRITER is a registered trademark of Oki Electric Industry Co., Ltd.

TIMING DIAGRAMS

1. Reactivation after One-shot Output

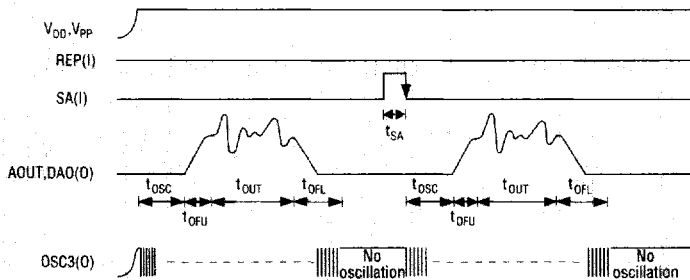

2. One-shot after Repeat

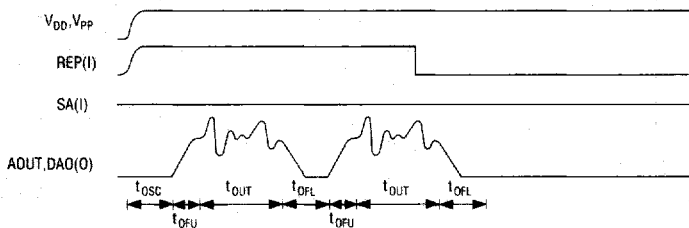

3. Repeat during Voice Output

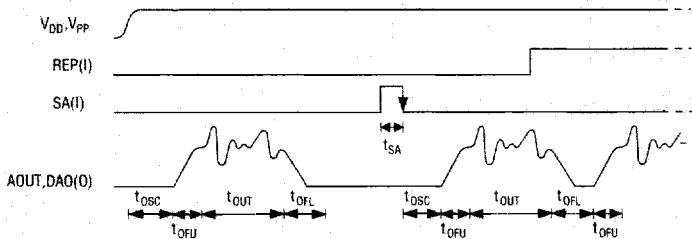

Note: When REP pin is merely set to "H" level, the voice is not output.

4. Reactivation during Voice Output

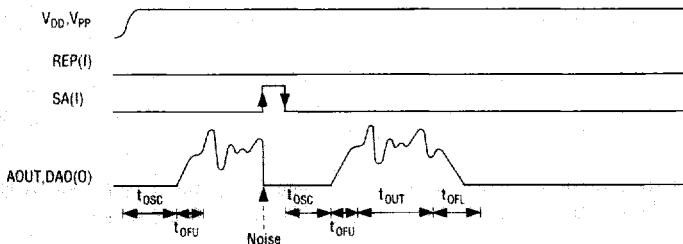

Note: When SA pin goes to "H" level during playback, voice is stopped and a noise is output.

FUNCTIONAL DESCRIPTION

1. Number of Phrases

One word only.

2. Relation among External R and C, Original Oscillation Frequency, and Voice Output Time

C (pF)		R1(kΩ)		R2 (kΩ)		fosc (kHz)	fsAM (kHz)	fcut (kHz)	tout1(sec) MSM6378A	tout2(sec) MSM6379
3V	5V	3V	5V	3V	5V					
100	100	200	200	56.5	60.5	64	4	1.5	15.6	32.0
100	100	200	200	34.5	36.5	96	6	2.2	10.4	21.3
100	100	200	200	23	25	128	8	2.9	7.8	16.0
100	100	200	200	16.5	18	160	10	3.6	6.2	12.8
100	100	200	200	12.5	14	192	12	4.4	5.2	10.6
100	100	200	200	9.5	11	224	14	5.1	4.5	9.1
100	100	200	200	7.5	9	256	16	5.8	3.9	8.0

$$* t_{OUT1} = \frac{244\text{Kbit}}{4\text{bit} \times f_{SAM}}$$

$$* t_{OUT2} = \frac{500\text{Kbit}}{4\text{bit} \times f_{SAM}}$$

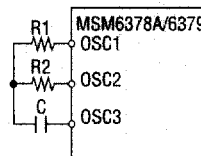

The values of C, R1, and R2 for the above table are for the MSM6378A 16-pin DIP. The oscillation frequency fluctuates with an external resistance and floating capacity. Therefore, since the oscillation frequency fluctuates when the board wiring and packages are different, determine the constant after check with monitoring f_{OSC} at OSC3 pin with reference to the above table.

3. Ceramic Oscillator ($f_{OSC}=256\text{kHz}$)

- Figure 3-1 shows an external circuit that used the ceramic oscillator CSB256D made by Murata MFG.
- Figure 3-2 shows an external circuit that used the ceramic oscillator KBR256B made by Kyocera Corporation.

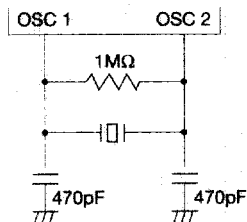

Figure 3-1 Ceramic Oscillator (CSB256D)
Connection Circuit

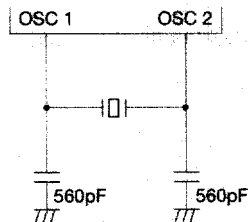

Figure 3-2 Ceramic Oscillator (KBR-256B)
Connection Circuit

4. Pop Noise Prevention

To prevent generation of pop noise before and after voice output, the MSM6378A/6379 contains a 12Kbit offset data area in the built-in OTP. The ANAWRITER for exclusive use automatically reads the offset data into the MSM6378A/6379.

5. Activation

The MSM6378A/6379 is activated as soon as the power is turned on (power-on start function). To reactivate from stand-by mode, apply a pulse on the SA pin, and the voice is again output.

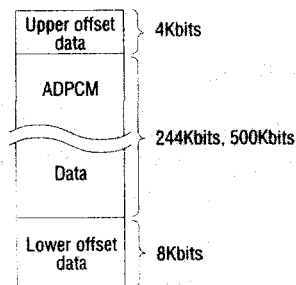

6. Repeat

The MSM6378A/6379 repeats when the REP pin is set to "H" level. However, the voice is not output when the REP pin is merely set to "H" level.

7. Standby Mode

When the REP pin is set to "L" level, the MSM6378A/6379 outputs one-shot voice and enters standby mode after the power is turned on or a pulse is applied to the SA pin. While in standby mode, internal oscillation stops and the OSC3 pin is set to "H" level.

8. Voice Output Pin

The MSM6378A/6379 has two voice output pins. The DAO pin is for internal DA converter output, and the AOUT pin is for DAO output via the LPF.

9. LPF Characteristic

The LPF cut-off frequency (f_{CUT}) is always proportional to original oscillation frequency. The following figure shows the LPF characteristic curve at 8kHz sampling frequency (with the original oscillation frequency set to 128kHz).

fosc (kHz)	fSAM (kHz)	fcut (kHz)
64	4	Approx. 1.5
96	6	Approx. 2.2
128	8	Approx. 2.9
160	10	Approx. 3.6
192	12	Approx. 4.4
224	14	Approx. 5.1
256	16	Approx. 5.8

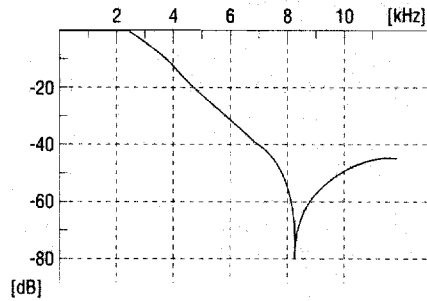

10. Pop Noise of Low-pass Filter Output

Although the MSM6378A/6379 has a built-in pop noise suppression circuit, the voltage of the circled portion in the figure below may be changed abruptly by approximately 0.7V when selecting the low-pass filter output and may generate a "pop" sound.

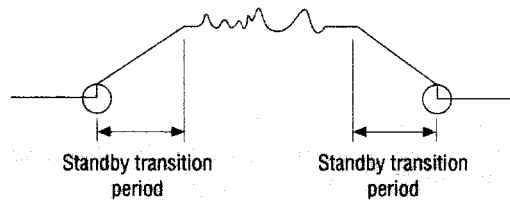

Pop Noise of Low-pass Filter Output

When connecting a diode at the output from AOUT, the "pop" sound can be reduced. The following figure shows its circuit.

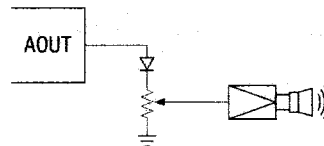

Pop Noise Suppression Circuit

APPLICATION CIRCUITS

1. Playback

1.1 When Standard AMP is used

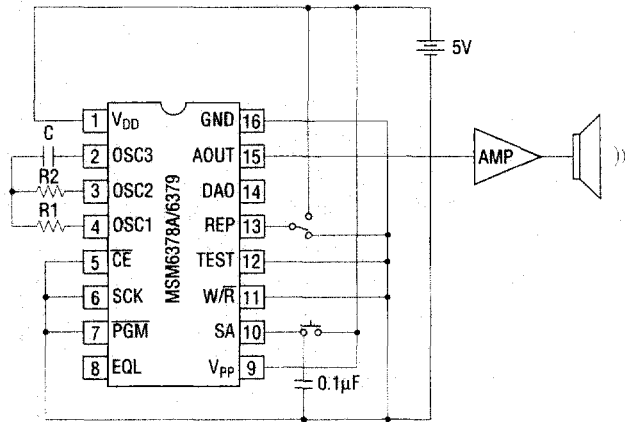

Note: The capacitor connected to the SA pin contributes to noise margin in the case of SA being "open".

1.2 Use of MSC1191 as AMP

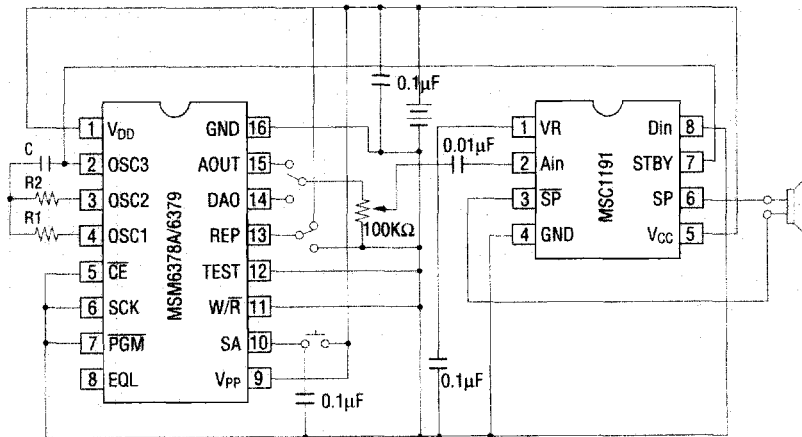

Note: The MSC1191 is the most suitable amplifier to drive a speaker for voice ICs. When the MSM6378A terminates the playback of voice data, the MSC1191 is also put into power save mode automatically.

2. Example of Write Circuit

(Equivalent to the playback circuit)

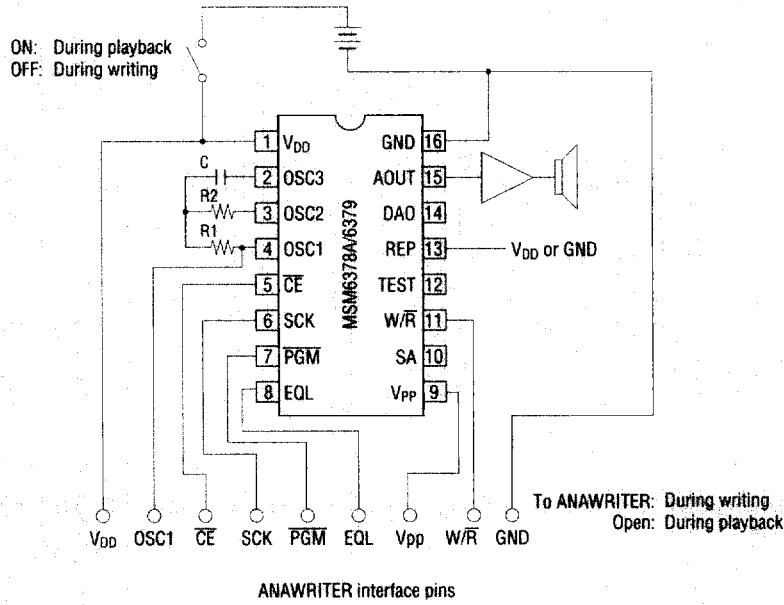

Note: Be careful about noise margin for input pins that are open during playback.