

TNC

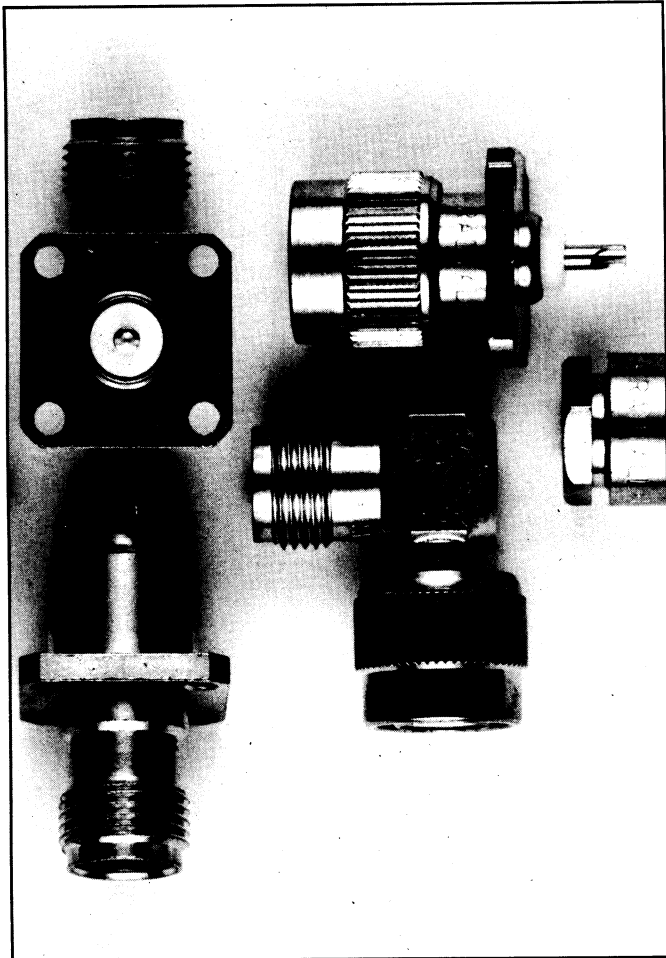

50 Ω	DC - 11 GHz maximum
75 Ω	DC - 1 GHz recommended DC - 1,5 GHz maximum

GENERAL

- Screw-on equivalent to BNC bayonet series
- Good RF performance
- Suitable for high power levels
- Long life and high strength
- 3 ranges :
 - TNC,
 - 75 Ω TNC
 - Precision 18 GHz TNC (shown only in full line TNC catalog)

APPLICABLE STANDARDS

- MIL-C-39012
- CEI 169-17

APPLICATIONS

- Avionics
- Aeronautics
- Computers
- Countermeasures

INTERFACE

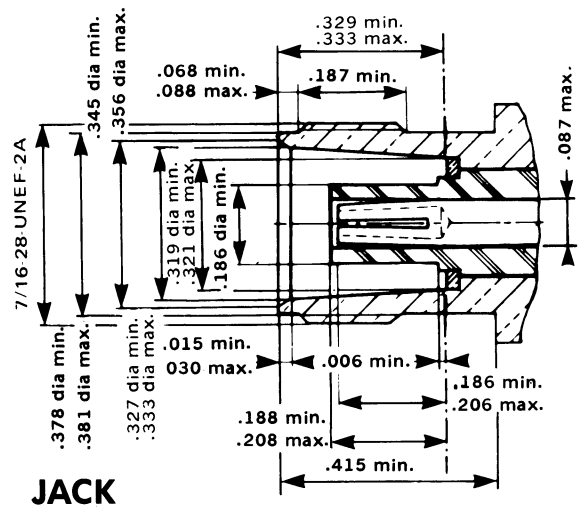
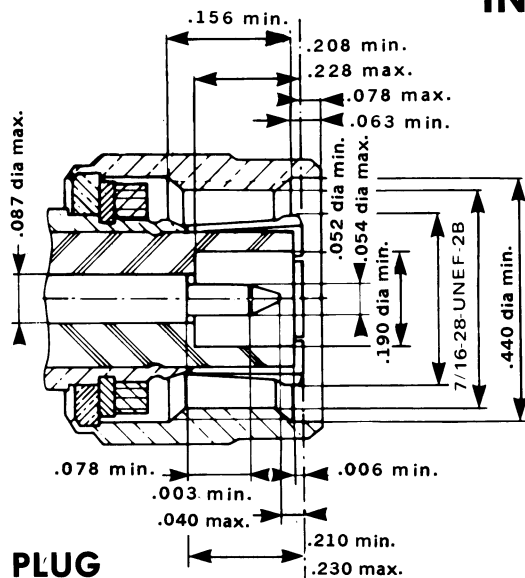

FLEXIBLE CABLE. CLAMP ATTACHMENT

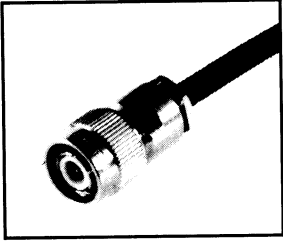

STRAIGHT CABLE PLUG
non-captured contact

PART No. **R 143 008**

Cable RG 55/U, 58, 141,
142, 223, 300, 400

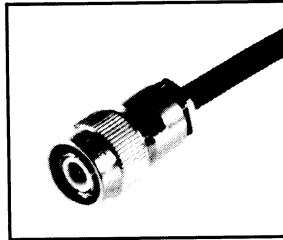

STRAIGHT CABLE PLUG
non-captured contact

PART No. **R 143 012**

Cable RG 59/U, 62, 71,
140, 210

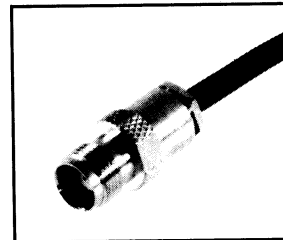

STRAIGHT CABLE JACK
non-captured contact

PART No. **R 143 207**

Cable RG 55/U, 58, 141,
142, 223, 300, 400

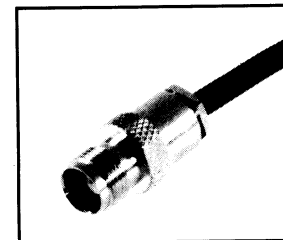

STRAIGHT CABLE JACK
captured contact

PART No. **R 143 210**

Cable RG 59/U, 62, 71,
140, 210

FLEXIBLE CABLE. CRIMP ATTACHMENT

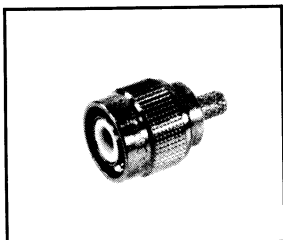

STRAIGHT CABLE PLUG
captured contact

PART No. **R 143 082**

Cable RG 58/U, 141, 303

PANEL MOUNT. SOLDER POT TERMINAL

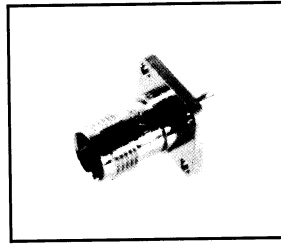

FLANGE MOUNT
JACK RECEPTACLE

PART No. **R 143 404**

BULKHEAD MOUNT. SOLDER POT TERMINAL

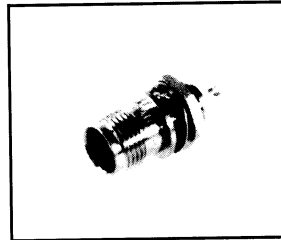

BULKHEAD FEEDTHROUGH
JACK RECEPTACLE

PART No. **R 143 557**

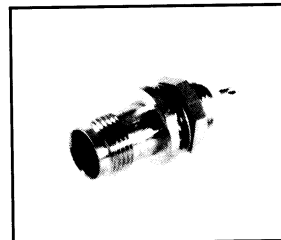

BULKHEAD FEEDTHROUGH
JACK RECEPTACLE

PART No. **R 143 603**

IN - SERIES ADAPTERS

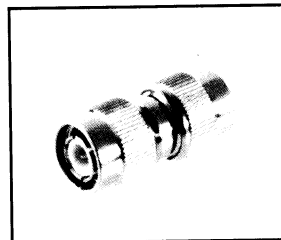

PLUG TO PLUG ADAPTER

PART No. **R 143 703**

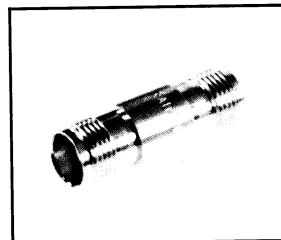

JACK TO JACK ADAPTER

PART No. **R 143 704**

50 Ω TNC

75 Ω TNC

IN - SERIES ADAPTERS

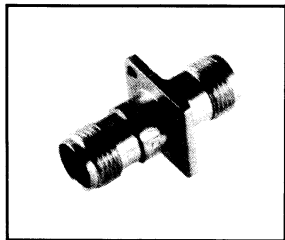

**JACK TO JACK ADAPTER
FLANGE MOUNT**

PART No. **R 143 710**

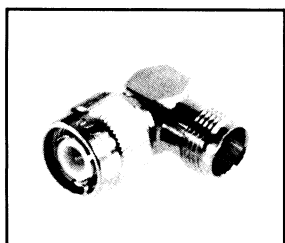

**PLUG TO JACK ADAPTER
RIGHT ANGLE**

PART No. **R 143 770**

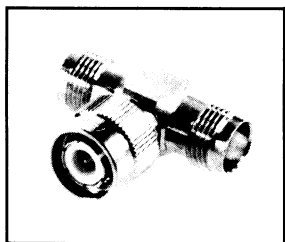

**TEE JACK TO PLUG TO JACK
ADAPTER**

PART No. **R 143 780**

FLEXIBLE CABLE. CLAMP ATTACHMENT

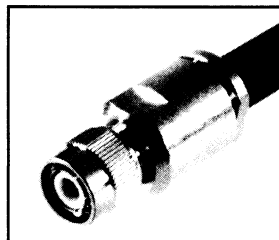

**STRAIGHT CABLE PLUG
captured contact**

PART No. **R 144 017**

Cable **RG 6A/U**

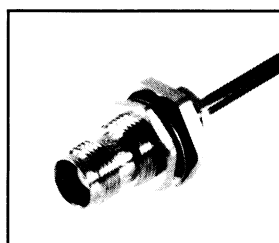

**BULKHEAD FEEDTHROUGH
CABLE JACK
captured contact**

PART No. **R 144 329**

Cable **RG 59/U, 62,
71, 140, 210**

FLEXIBLE CABLE. CRIMP ATTACHMENT

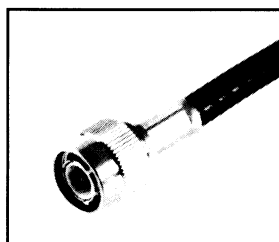

**STRAIGHT CABLE PLUG
captured contact**

PART No. **R 144 085**

Cable **RG 59/U, 62, 71,
140, 210**

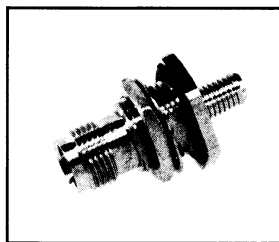

**BULKHEAD FEEDTHROUGH
CABLE JACK
captured contact**

PART No. **R 144 334**

Cable **RG 59/U, 62,
71, 140, 210**