

PTC Thermistors, Inrush Current Limiter

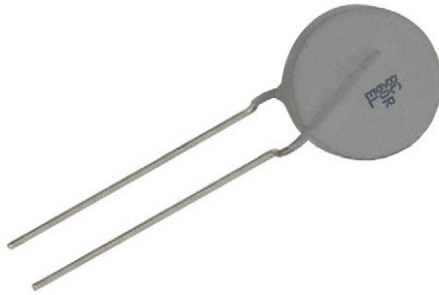

LINKS TO ADDITIONAL RESOURCES



QUICK REFERENCE DATA		
PARAMETER ⁽¹⁾	VALUE	UNIT
Resistance at 25 °C (R_{25}) ⁽²⁾	60 to 1000	Ω
Switching temperature	130 to 140	°C
Maximum inrush current	10 to 40	A
Maximum AC voltage ⁽²⁾	350 to 800	V_{RMS}
Maximum DC voltage ⁽²⁾	500 to 1200	V_{DC}
Maximum peak voltage ⁽³⁾	4000	V_P
Maximum energy ⁽¹⁾	150 to 240	J
Operating temperature range	-40 to 105	°C
Storage temperature range	-55 to 165	°C
Dissipation factor	14.5 to 19.5	mW/K
Thermal time constant (τ_c) (still air cooling)	130 to 155	s
Weight	3.5 to 5.7	g

Notes

- ⁽¹⁾ Definitions, measurements, and tests are made in accordance with standard IEC 60738-1 "Thermistors - Directly heated positive temperature coefficient" and AEC-Q200 stress test qualification for passive components
- ⁽²⁾ Other resistance values and maximum operating voltages available on request.
Matched resistance values available on request
- ⁽³⁾ Maximum peak voltages are based on 8/20 μ s pulses that can be applied with limited non-switching energy

AGENCY APPROVALS

Agency approval documents, please see:

www.vishay.com/ppg?29165&documents

UL recognition standard for safety is UL 1434: "Thermistor-Type Devices". UL file E148885

FEATURES

- High energy absorption levels up to 150 J and 240 J
- High number of inrush-power cycles: > 100 000 cycles
- Highly resistant against non-switching peak-powers of up to 25 kW
- Can handle high direct voltage up to 1200 V
- Self protecting in case of overload with no risk of over-heating
- AEC-Q200 qualified
- C-UL-US recognized under file E148885 for AC and DC use
- Material categorization: for definitions of compliance please see www.vishay.com/doc?99912



RoHS
COMPLIANT

APPLICATIONS

Inrush current limiting and load-dump resistor in:

- AC/DC and DC/DC converters
- Load dump and DC-Link circuits
- Emergency discharge circuits
- OBC, battery charging equipment
- Motor drives
- Welding equipment

PTCEL thermistors have resistance values that can change instantly based on the applied voltage levels and varying body temperatures.

DESCRIPTION

These directly heated ceramic-based doped barium titanate thermistors have a positive temperature coefficient and are primarily intended for inrush current limiting and overload protection. They consist of a ceramic pellet soldered between two tinned CCS wires and coated with a UL 94 V-0 compliant high temperature silicone lacquer. The body is marked with the logo, cold resistance value, EL on one side and date code on the opposite side.

MOUNTING

Important mounting and handling instructions, see:

www.vishay.com/doc?29223

By soldering in any position.

Not intended for potting or sealing.

Maximum surface temperature in case of overload can reach 200 °C.

PACKAGING

PTC thermistors are available in 100 pieces (PTCEL13) or 50 pieces (PTCEL17) layered bulk packed or tape on reel 500 pieces.

ELECTRICAL DATA AND ORDERING INFORMATION											
PART NUMBER ⁽¹⁾	R_{25} (Ω)	R_{25} TOL. (%)	$V_{MAX.}$ (V_{RMS})	$V_{LINK MAX.}$ (V_{DC})	$R_{MIN.}$ < 1.5 V_{DC} (Ω)	I_{HOLD} AT 25°C (mA)	C_{th} (J/K)	$E_{MAX.}$ 1 CYCLE AT 25°C (J)	τ_{th} (s)	LEAD PITCH F (mm)	UL RECOG.
PTCEL13R600LxE	60	30	350	500	32	120	1.45	150	130	5.0	✓
PTCEL13R121MxE	120	30	440	625	64	85	1.45	150	130	5.0	✓
PTCEL13R251NxE	250	30	480	680	130	60	1.45	150	130	5.0	✓
PTCEL13R501RxE	500	30	560	800	260	42	1.45	150	130	5.0	✓
PTCEL13R102SxE	1000	30	600	850	520	30	1.45	140	130	5.0	✓
PTCEL17R600MxE	60	30	440	625	32	140	2.3	240	155	5.0	✓
PTCEL17R600MxE303	60	30	440	625	32	140	2.3	240	155	7.5	✓
PTCEL17R121NxE	120	30	460	650	64	100	2.3	240	155	5.0	✓
PTCEL17R251SxE	250	30	600	850	130	70	2.3	240	155	5.0	✓
PTCEL17R501TxE	500	30	700	1000	260	50	2.3	230	155	5.0	✓
PTCEL17R501TxE302	500	30	700	1000	260	50	2.3	230	155	7.5	✓
PTCEL17R501TxE401	500	30	700	1000	260	50	2.3	230	155	10.0	✓
PTCEL17R102UxE404	1000	30	800	1200	500	35	2.3	230	155	10.0	

Note

⁽¹⁾ Replace the x by B for bulk or T for tape and reel

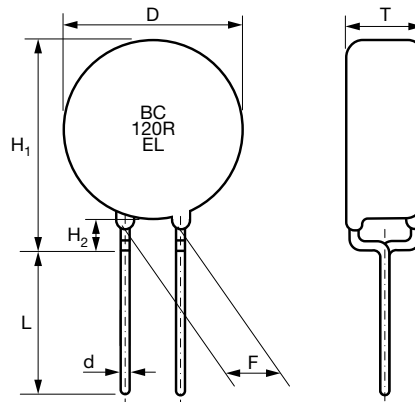
OUTLINE AND DIMENSIONS

COMPONENT DIMENSIONS in millimeters					
SYMBOL	PTCEL13		PTCEL17		
D	13.5 max.		16.5 max.		
d	0.6 ± 0.05		0.8 ± 0.05		
H ₁	17 max.		20 max.		
H ₂	3 ± 1		3 ± 1		
T	7.0 max.		7.5 max.		
F ⁽¹⁾	5.0 ± 0.8	7.5 ± 0.8	5.0 ± 0.8	7.5 ± 0.8	10.0 ± 0.8
L ⁽²⁾	20 min.	18 min.	20 min.	18 min.	16 min.

Notes

⁽¹⁾ F pitch = see "Electrical Data and Ordering Information" table for available wire pitch part numbers

⁽²⁾ L lead length corresponds to available wire pitch part numbers

TAPE AND REEL DIMENSIONS

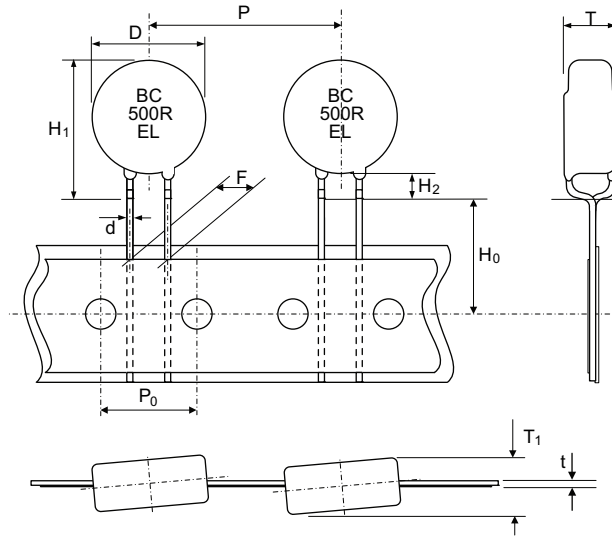
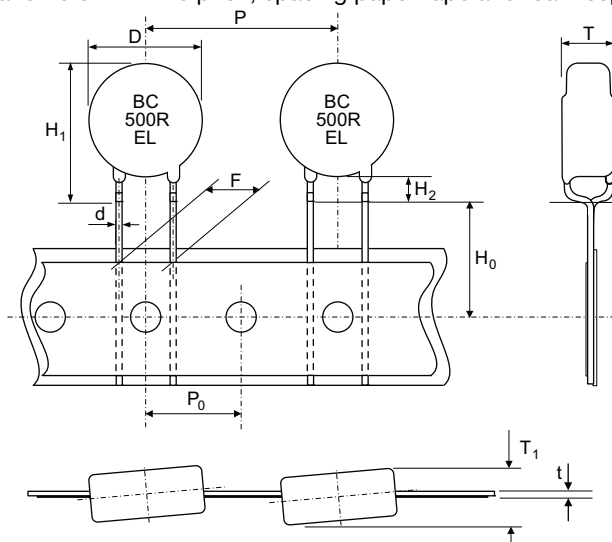
 Taping on reel with $F = 5.0$ mm wire pitch, spacing paper tape and foam separator tape used on reel.

 Taping on reel with $F = 7.5$ mm and 10.0 mm wire pitch, spacing paper tape and foam separator tape used on reel.

DIMENSIONS in millimeters (according IEC 60286-2)		
SYMBOL	PARAMETER	VALUE
D	Body diameter	See bulk dimensions
d	Lead diameter	See bulk dimensions
P	Component pitch	25.4 ± 1.0
P_0	Feedhole pitch	12.7 ± 0.3
F	Lead center to lead center distance (between component and tape)	
	13R and 17R type *TE (leads between feedholes)	$5.0 +0.5/-0.2$
	13R and 17R type *TE3xx (feedhole between leads)	$7.5 +0.5/-0.2$
	17R type *TE4xx (feedhole between leads)	$10.0 +0.5/-0.2$
H_0	Lead wire clinch height	16.0 ± 0.5
H_2	Component bottom to seating plane	3.0 ± 1.0
H_1	Component top to seating plane	See bulk dimensions
T	Body thickness	See bulk dimensions
T_1	Total thickness	$T + 1.0$ max.



REQUIRED NUMBER OF PTC THERMISTORS TO LIMIT CURRENT AND ABSORB ENERGY

By using several PTC's in a series / parallel network, the maximum current limitation and absorbed energy levels can be further optimized. For homogeneous current and energy distribution it is recommended to combine only PTCEL of the same size and matched resistance value. Energy absorption per PTC in a network depends on current distribution in the network and as such on the individual PTC resistance value. PTCEL thermistors might be used in a series connection to further lower the inrush current, but not to increase the maximum allowed voltage levels. Following formula may be used to calculate the minimum number of PTCEL thermistors of the same size and matched resistance value that are required in a DC link or other capacitor bank application to properly charge or discharge a given amount of non-repetitive energy without follow current. The formula is valid for one charge or discharge operation within cool down period of at least 5 times the thermal time constant and for which the T_PTC equals the T_amb before a consecutive operation.

N >= (K x C x V^2) / (2 x C_th x (T_sw - T_amb))

Notes

- N is the number of PTCEL required in the network
• C is the total capacitor value to charge or discharge in F
• V is the maximum DC voltage on the capacitor C
• C_th is the thermal capacity of one PTC in [J/K] (see table)
• T_sw is the minimum switching temperature of the PTCEL (130 °C)
• T_amb is the maximum ambient temperature at which the PTC needs to operate
• K is the factor that determines the charging operation mode
K = 1 for DC charging or discharging
K = 0.96 for 3-phase rectified charging
K = 0.76 for single phase rectified charging

RESISTANCE VS. TEMPERATURE FOR PTCEL13 (Typical)

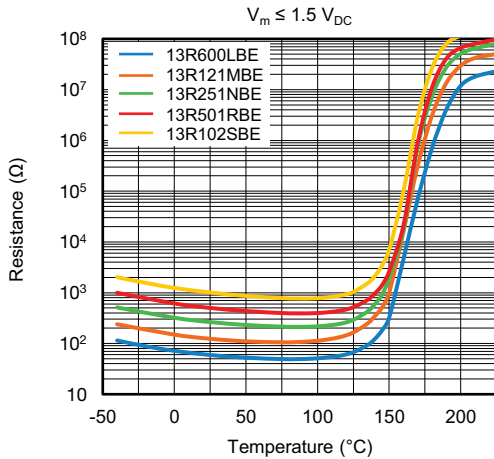

RESISTANCE VS. TEMPERATURE FOR PTCEL17 (Typical)

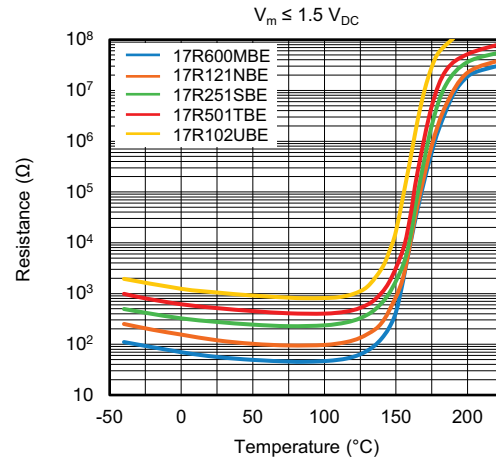

V_max. DERATING VS. T_amb

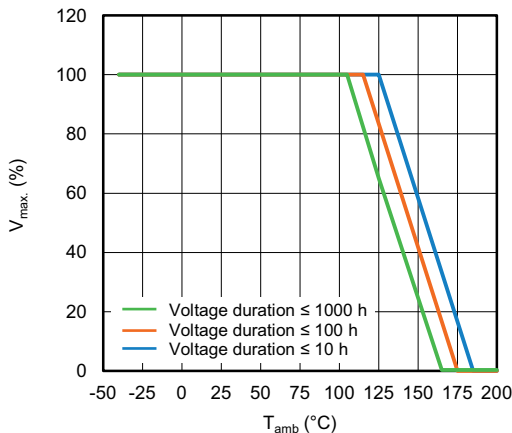

PTC RESISTANCE UNDER PULSED VOLTAGE

RESISTANCE VS. TEMPERATURE PULSED
(Typical)

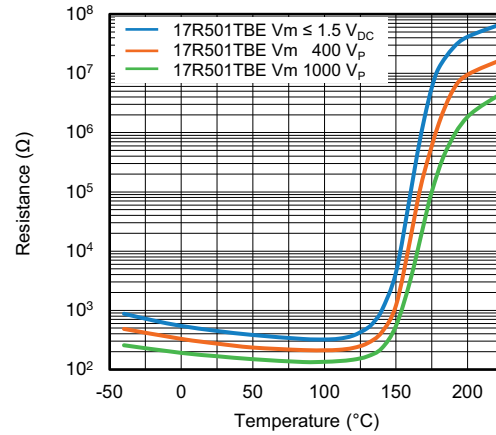
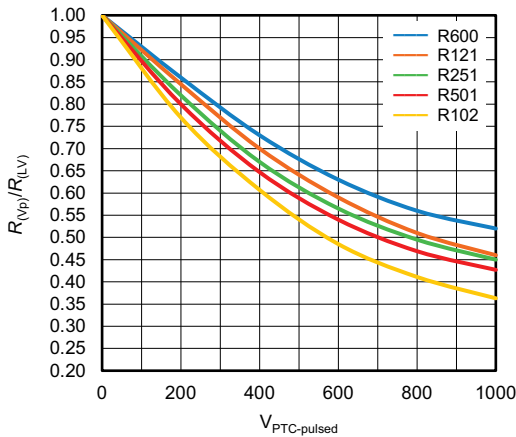

Notes

- The minimum PTC resistance values under (pulsed) voltage are depending on actual minimum resistance value in the temperature range of 70 °C to 100 °C. The actual voltage dependency effect or $R_{(Vp)}/R_{(LV)}$ ratio of ceramic PTC is depending on its resistance values at low voltage ($R_{(LV)}$). The different curves represent the influence of (V_p) voltage related to the PTCEL value types in the minimum resistance temperature range of 70 °C to 100 °C. A PTC resistance value $R_{(LV)}$ can be taken from the “Resistance vs Temperature” graphs and multiplied by a corresponding ratio to estimate the (minimum) resistance value and determine a maximum peak current at a defined voltage. Example: a PTCEL17R501TBE type has a R_{min} . (see Electrical Data table) of 260 Ω at around 90 °C, and at a 1000 V peak-voltage the resistance will drop to 260 Ω x 0.43 (red curve) = 112 Ω , which will give rise to a peak-current of around 9 Ap. Actual peak currents that could be reached at certain voltage levels can be more precisely evaluated by using the available SPICE models
- Also check the graph “Resistance vs. Temperature Pulsed” to see the typical resistance to voltage dependency effect on a PTCEL17R501TBE

RESIDUAL CURRENT VS. VOLTAGE FOR PTCEL13

RESIDUAL CURRENT VS. VOLTAGE FOR PTCEL17

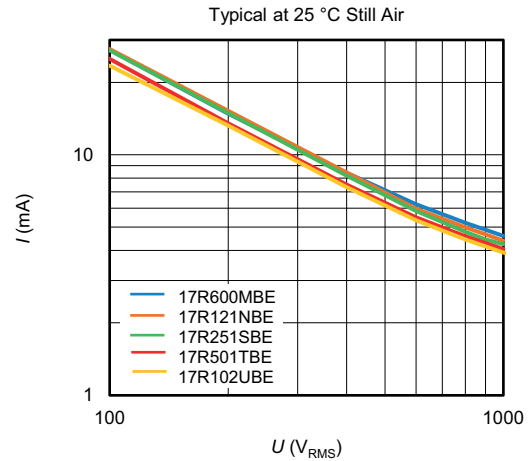
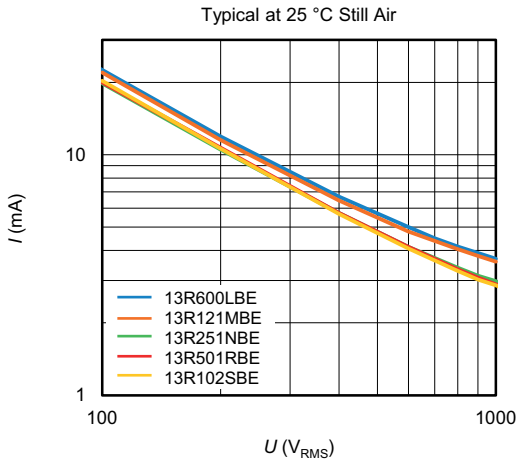



RESIDUAL CURRENT VS. VOLTAGE AC / DC

Typical at 25 °C Still Air

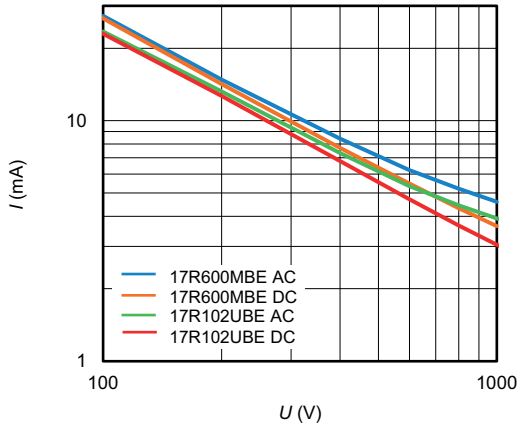

CONSECUTIVE ENERGY AT DIFFERENT T_{amb} FOR PTCEL13

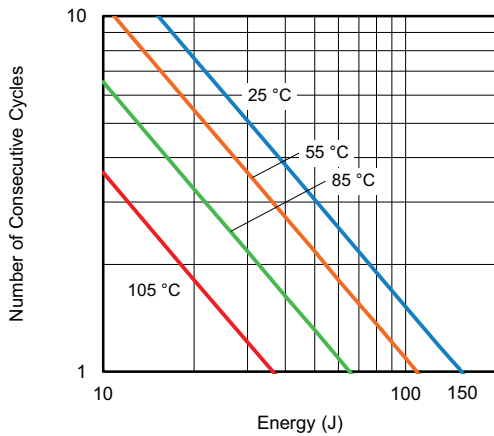

CONSECUTIVE ENERGY AT DIFFERENT T_{amb} FOR PTCEL17

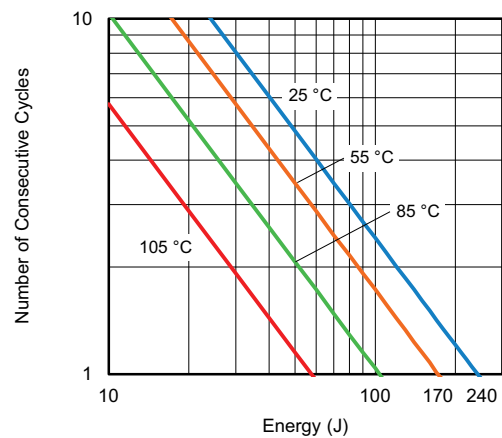



Disclaimer

ALL PRODUCT, PRODUCT SPECIFICATIONS AND DATA ARE SUBJECT TO CHANGE WITHOUT NOTICE TO IMPROVE RELIABILITY, FUNCTION OR DESIGN OR OTHERWISE.

Vishay Intertechnology, Inc., its affiliates, agents, and employees, and all persons acting on its or their behalf (collectively, "Vishay"), disclaim any and all liability for any errors, inaccuracies or incompleteness contained in any datasheet or in any other disclosure relating to any product.

Vishay makes no warranty, representation or guarantee regarding the suitability of the products for any particular purpose or the continuing production of any product. To the maximum extent permitted by applicable law, Vishay disclaims (i) any and all liability arising out of the application or use of any product, (ii) any and all liability, including without limitation special, consequential or incidental damages, and (iii) any and all implied warranties, including warranties of fitness for particular purpose, non-infringement and merchantability.

Statements regarding the suitability of products for certain types of applications are based on Vishay's knowledge of typical requirements that are often placed on Vishay products in generic applications. Such statements are not binding statements about the suitability of products for a particular application. It is the customer's responsibility to validate that a particular product with the properties described in the product specification is suitable for use in a particular application. Parameters provided in datasheets and / or specifications may vary in different applications and performance may vary over time. All operating parameters, including typical parameters, must be validated for each customer application by the customer's technical experts. Product specifications do not expand or otherwise modify Vishay's terms and conditions of purchase, including but not limited to the warranty expressed therein.

Hyperlinks included in this datasheet may direct users to third-party websites. These links are provided as a convenience and for informational purposes only. Inclusion of these hyperlinks does not constitute an endorsement or an approval by Vishay of any of the products, services or opinions of the corporation, organization or individual associated with the third-party website. Vishay disclaims any and all liability and bears no responsibility for the accuracy, legality or content of the third-party website or for that of subsequent links.

Except as expressly indicated in writing, Vishay products are not designed for use in medical, life-saving, or life-sustaining applications or for any other application in which the failure of the Vishay product could result in personal injury or death. Customers using or selling Vishay products not expressly indicated for use in such applications do so at their own risk. Please contact authorized Vishay personnel to obtain written terms and conditions regarding products designed for such applications.

No license, express or implied, by estoppel or otherwise, to any intellectual property rights is granted by this document or by any conduct of Vishay. Product names and markings noted herein may be trademarks of their respective owners.