

T-67-11-51

CD4028A Types

CMOS
BCD-to-Decimal Decoder

The RCA-CD4028A types are BCD-to-decimal or binary-to-octal decoders consisting of pulse-shaping circuits on all 4 inputs, decoding-logic gates, and 10 output buffers. A BCD code applied to the four inputs, A to D, results in a high level at the selected one of 10 decimal decoded outputs. Similarly, a 3-bit binary code applied to Inputs A through C is decoded in octal code at output 0 to 7. A high-level signal at the D input inhibits octal decoding and causes outputs

0 through 7 to go low. If unused, the D input must be connected to V_{SS}. High drive capability is provided at all outputs to enhance dc and dynamic performance in high fan-out applications.

These types are supplied in 16-lead hermetic dual-in-line ceramic packages (D and F suffixes), 16-lead dual-in-line plastic package (E suffix), 16-lead ceramic flat package (K suffix), and in chip form (H suffix).

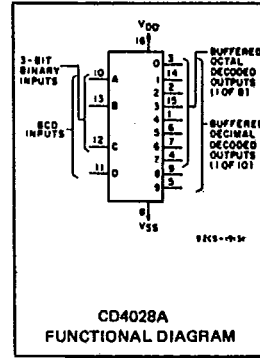

MAXIMUM RATINGS, Absolute-Maximum Values:

STORAGE-TEMPERATURE RANGE (T _{stg})	-65 to +150°C
OPERATING-TEMPERATURE RANGE (T _A):	
PACKAGE TYPES D, F, K, H	-55 to +125°C
PACKAGE TYPE E	-40 to +85°C
DC SUPPLY-VOLTAGE RANGE, (V _{DD})	
(Voltages references to V _{SS} Terminal)	-0.5 to +15 V
POWER DISSIPATION PER PACKAGE (P _D):	
FOR T _A = -40 to +60°C (PACKAGE TYPE E)	500 mW
FOR T _A = +60 to +85°C (PACKAGE TYPE E)	Derate Linearly at 12 mW/°C to 200 mW
FOR T _A = -55 to +100°C (PACKAGE TYPES D, F, K)	500 mW
FOR T _A = +100 to +125°C (PACKAGE TYPES D, F, K)	Derate Linearly at 12 mW/°C to 200 mW
DEVICE DISSIPATION PER OUTPUT TRANSISTOR	
FOR T _A = FULL PACKAGE-TEMPERATURE RANGE (ALL PACKAGE TYPES)	100 mW
INPUT VOLTAGE RANGE, ALL INPUTS	-0.5 to V _{DD} +0.5 V
LEAD TEMPERATURE (DURING SOLDERING):	
At distance 1/16 ± 1/32 inch (1.59 ± 0.79 mm) from case for 10 s max.	+265°C

Features:

- BCD-to-decimal decoding or binary-to-octal decoding
- High decoded output drive capability... 8 mA (typ.) sink or source
- "Positive logic" inputs and outputs... decoded outputs go high on selection
- Medium-speed operation... t_{THL}, t_{TLH} = 30 ns (typ.) @ V_{DD} = 10 V
- Quiescent current specified to 15 V
- Maximum input leakage current of 1 μA at 15 V (full package-temperature range)
- 1-V noise margin (full package-temperature range)

Applications:

- Code conversion
- Address decoding—memory selection control
- Indicator-tube decoder

RECOMMENDED OPERATING CONDITIONS

For maximum reliability, nominal operating conditions should be selected so that operation is always within the following ranges:

CHARACTERISTIC	V _{DD} (V)	LIMITS				UNITS
		D, F, K, H PACKAGES		E PACKAGE		
		MIN.	MAX.	MIN.	MAX.	
Supply-Voltage Range (For T _A =Full Package-Temperature Range)		3	12	3	12	V

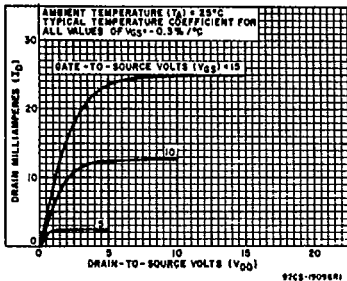

Fig. 1 - Typical output n-channel drain characteristics.

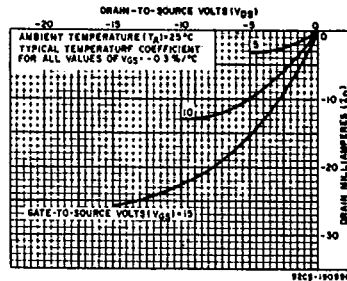

Fig. 2 - Typical output p-channel drain characteristics.

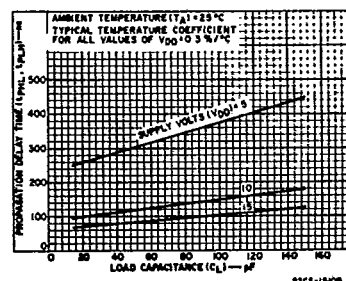

Fig. 3 - Typical propagation delay time vs. C_L.

T-67-11-51

CD4028A Types

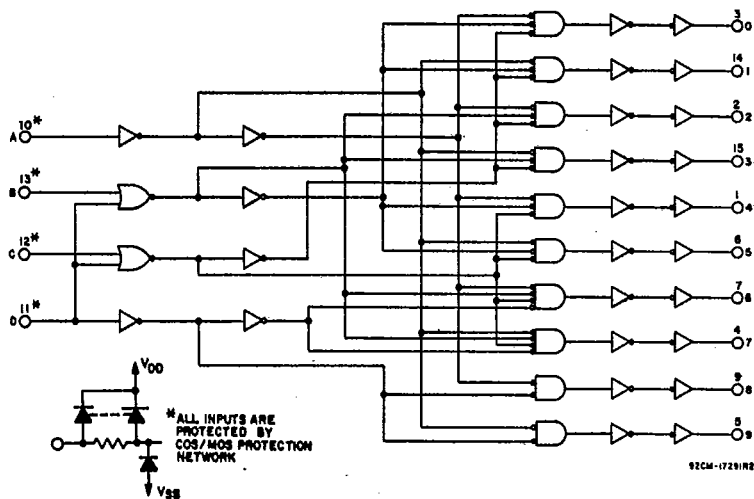

Fig. 4 - Logic diagram.

TABLE I - TRUTH TABLE

DCBA	0	1	2	3	4	5	6	7	8	9
0000	1	0	0	0	0	0	0	0	0	0
0001	0	1	0	0	0	0	0	0	0	0
0010	0	0	1	0	0	0	0	0	0	0
0011	0	0	0	1	0	0	0	0	0	0
0100	0	0	0	0	1	0	0	0	0	0
0101	0	0	0	0	0	1	0	0	0	0
0110	0	0	0	0	0	0	1	0	0	0
0111	0	0	0	0	0	0	0	1	0	0
1000	0	0	0	0	0	0	0	0	1	0
1001	0	0	0	0	0	0	0	0	0	1
1010	0	0	0	0	0	0	0	0	0	1
1011	0	0	0	0	0	0	0	0	0	1
1100	0	0	0	0	0	0	0	0	0	1
1101	0	0	0	0	0	0	0	0	0	1
1110	0	0	0	0	0	0	0	0	0	1
1111	0	0	0	0	0	0	0	0	0	1

* WHERE 1 = HIGH LEVEL
0 = LOW LEVEL

** EXTRAORDINARY STATES

STATIC ELECTRICAL CHARACTERISTICS

CHARACTERISTIC	CONDITIONS			LIMITS AT INDICATED TEMPERATURES (°C)							UNITS	
	V _O (V)	V _{IN} (V)	V _{DD} (V)	D, F, K, H PACKAGES			E PACKAGE					
				-55	+25		-40	+25		+85		
Quiescent Device Current, I _L Max.	-	-	5	5	0.5	5	300	50	5	50	700	μA
	-	-	10	10	1	10	600	100	10	100	1400	
	-	-	15	50	1	50	2000	500	10	500	5000	
Output Voltage: Low-Level, V _{OL}	-	5	5	0 Typ.; 0.05 Max.								V
	-	10	10	0 Typ.; 0.05 Max.								
High Level V _{OH}	-	0	5	4.95 Min.; 5 Typ.								V
	-	0	10	9.95 Min.; 10 Typ.								
Noise Immunity: Inputs Low, V _{NL}	4.2	-	5	1.5 Min.; 2.25 Typ.								V
	9	-	10	3 Min.; 4.5 Typ.								
Inputs High V _{NH}	0.8	-	5	1.5 Min.; 2.25 Typ.								V
	1	-	10	3 Min.; 4.5 Typ.								
Noise Margin: Inputs Low, V _{NML}	4.5	-	5	1 Min.								V
	9	-	10	1 Min.								
Inputs High, V _{NMH}	0.5	-	5	1 Min.								V
	1	-	10	1 Min.								
Output Drive Current N-Channel (Sink), I _{DN} Min.	0.5	-	5	0.75	1.2	0.6	0.45	0.35	1.2	0.3	0.25	mA
	0.5	-	10	1.5	2.4	1.2	0.9	0.7	2.4	0.6	0.5	
P-Channel (Source), I _{DP} Min.	4.5	-	5	-0.7	-0.9	-0.45	-0.32	-0.32	-0.9	-0.22	-0.18	mA
	9	-	10	-1.4	-1.9	-0.95	-0.65	-0.65	-1.9	-0.48	-0.4	
Input Leakage Current, I _{IL} , I _{IH}	-	-	15	±10 ⁻⁵ Typ., ±1 Max.							μA	

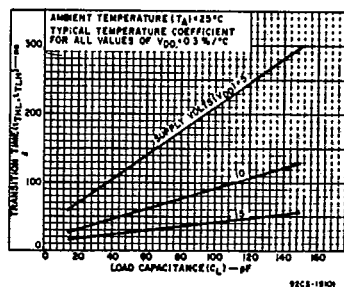

Fig. 5 - Typical transition time vs. C_L.

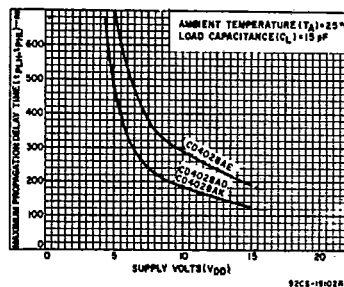

Fig. 6 - Maximum propagation delay time vs. V_{DD}.

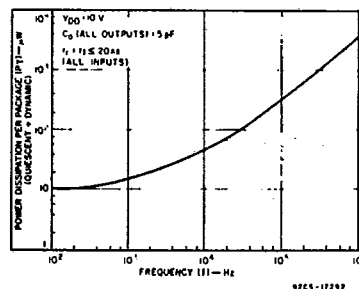
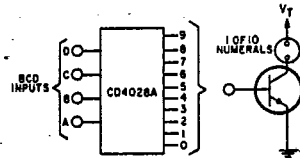

Fig. 7 - Dissipation vs. input frequency.

CD4028A Types

DYNAMIC ELECTRICAL CHARACTERISTICS
 at $T_A = 25^\circ C$, Input $t_r, t_f = 20 \text{ ns}$, $C_L = 15 \text{ pF}$, $R_L = 200 \text{ k}\Omega$

CHARACTERISTIC	TEST CONDITIONS	LIMITS						UNITS
		D, F, K, H PACKAGES			E PACKAGE			
		VDD (V)	MIN.	TYP.	MAX.	MIN.	TYP.	
Propagation Delay Time; t_{PLH}, t_{PHL}	5	-	260	480	-	260	700	ns
	10	-	100	180	-	100	290	
Transition Time; t_{THL}, t_{TLH}	5	-	60	150	-	60	300	ns
	10	-	30	75	-	30	150	
Average Input Capacitance, C_i	Any Input	-	5	-	-	5	-	pF



▲ (Trademark) Burroughs Corp. 92CS-17295M

Type	V_T (Vdc)	mA/numeral
Burroughs 84081	170	1.4
84336/718	170	2
84027	170	1.4
84021	120	1.4

TRANSISTOR CHARACTERISTICS
 Leakage with transistor cutoff $\leq 0.08 \text{ mA}$
 $V_{IBRICEO} = 2.75 \text{ V}$

Fig. 9 - Neon readout (Nixie Tube[▲]) display application.

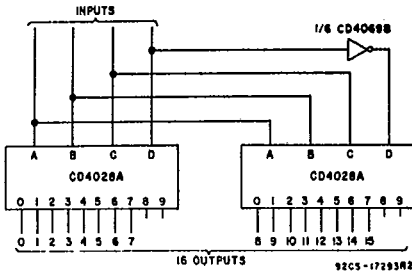

Fig. 8 - Code conversion circuit.

The circuit shown in Fig. 9 converts any 4-bit code to a decimal or hexadecimal code. Table 2 shows a number of codes and the decimal or hexadecimal number in these codes which must be applied to the input terminals of the CD4028A to select a particular output. For example: in order to get a high on output No. 8 the input must be either an 8 expressed in 4-Bit Binary code, a 15 expressed in 4-Bit Gray code, or a 5 expressed in Excess-3 code.

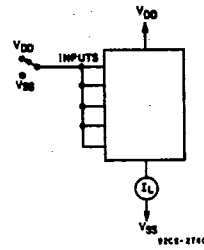

Fig. 10 - Quiescent device current test circuit.

TABLE II - CODE CONVERSION CHART

INPUTS				INPUT CODES					OUTPUT NUMBER																		
				Hexa-Decimal		Decimal																					
D	C	B	A	4-BIT BINARY	4-BIT GRAY	EXCESS-3	EXCESS-3 GRAY	AIKEN	4-2-2-1	0	1	2	3	4	5	6	7	8	9	10	11	12	13	14	15		
0	0	0	0	0	0	0	0	0	0	0	0	0	0	0	0	0	0	0	0	0	0	0	0	0	0	0	
0	0	0	1	1	1	1	1	1	1	0	1	0	0	0	0	0	0	0	0	0	0	0	0	0	0	0	
0	0	1	0	2	3	0	2	2	0	0	0	1	0	0	0	0	0	0	0	0	0	0	0	0	0	0	
0	0	1	1	3	2	0	3	3	0	0	0	1	0	0	0	0	0	0	0	0	0	0	0	0	0	0	
0	1	0	0	4	7	1	4	4	0	0	0	0	1	0	0	0	0	0	0	0	0	0	0	0	0	0	
0	1	0	1	5	6	2	5	3	0	0	0	0	0	1	0	0	0	0	0	0	0	0	0	0	0	0	
0	1	1	0	6	4	3	1	4	0	0	0	0	0	0	1	0	0	0	0	0	0	0	0	0	0	0	
0	1	1	1	7	5	4	2	3	0	0	0	0	0	0	0	1	0	0	0	0	0	0	0	0	0	0	
1	0	0	0	8	15	6	7	5	0	0	0	0	0	0	0	0	1	0	0	0	0	0	0	0	0	0	
1	0	0	1	9	14	8	6	4	0	0	0	0	0	0	0	0	1	0	0	0	0	0	0	0	0	0	
1	0	1	0	10	12	7	9	6	0	0	0	0	0	0	0	0	0	1	0	0	0	0	0	0	0	0	
1	0	1	1	11	13	8	5	4	0	0	0	0	0	0	0	0	0	1	0	0	0	0	0	0	0	0	
1	1	0	0	12	8	9	5	6	0	0	0	0	0	0	0	0	0	0	0	1	0	0	0	0	0	0	
1	1	0	1	13	9	6	7	7	0	0	0	0	0	0	0	0	0	0	0	0	0	0	0	0	1	0	0
1	1	1	0	14	11	8	8	5	0	0	0	0	0	0	0	0	0	0	0	0	0	0	0	0	0	1	0
1	1	1	1	15	10	7	9	6	0	0	0	0	0	0	0	0	0	0	0	0	0	0	0	0	0	0	1

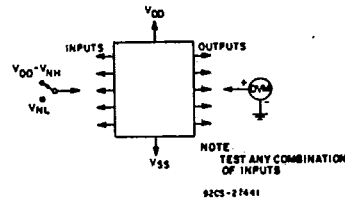

Fig. 11 - Noise-immunity test circuit.

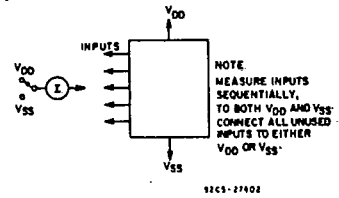
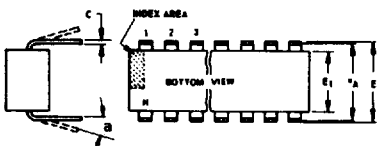
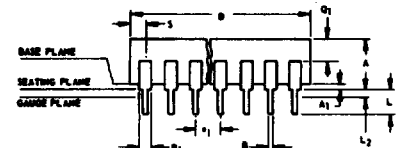

Fig. 12 - Input-leakage-current test circuit.

Dimensional Outlines

Dual-In-Line Welded-Seal Ceramic Packages



- NOTES:**
Refer to Rules for Dimensioning (JEDEC Publication No. 95) for Axial Lead Product Outlines.
- When this device is supplied solder-dipped, the maximum lead thickness (narrow portion) will not exceed 0.013" (0.33 mm).
 - Leads within 0.005" (0.12 mm) radius of True Position (TP) at gauge plane with maximum material condition and unit installed.
 - e_A applies in zone L₂ when unit installed.
 - a applies to spread leads prior to installation.
 - N is the maximum quantity of lead positions.
 - N₁ is the quantity of allowable missing leads.

(D) SUFFIX (JEDEC MO-001-AD)
14-Lead Dual-In-Line Welded-Seal Ceramic Package

SYMBOL	INCHES		NOTE	MILLIMETERS	
	MIN.	MAX.		MIN.	MAX.
A	0.120	0.160		3.05	4.06
A ₁	0.020	0.065		0.51	1.65
B	0.014	0.020		0.356	0.508
B ₁	0.060	0.065		1.27	1.65
C	0.008	0.012	1	0.204	0.304
D	0.745	0.770		18.93	19.55
E	0.300	0.325		7.62	8.25
E ₁	0.240	0.260		6.10	6.60
e ₁	0.100 TP		2	2.54 TP	
e _A	0.300 TP		2, 3	7.62 TP	
L	0.125	0.150		3.18	3.81
L ₂	0.000	0.030		0.000	0.76
a	0°	15°	4	0°	15°
N	14		5	14	
N ₁	0		6	0	
Q ₁	0.050	0.085		1.27	2.15
S	0.065	0.090		1.66	2.28

92SS-4411R2

(D) SUFFIX (JEDEC MO-001-AE)
16-Lead Dual-In-Line Welded-Seal Ceramic Package

SYMBOL	INCHES		NOTE	MILLIMETERS	
	MIN.	MAX.		MIN.	MAX.
A	0.120	0.160		3.05	4.06
A ₁	0.020	0.065		0.51	1.65
B	0.014	0.020		0.356	0.508
B ₁	0.035	0.065		0.89	1.65
C	0.008	0.012	1	0.204	0.304
D	0.745	0.785		18.93	19.93
E	0.300	0.325		7.62	8.25
E ₁	0.240	0.260		6.10	6.60
e ₁	0.100 TP		2	2.54 TP	
e _A	0.300 TP		2, 3	7.62 TP	
L	0.125	0.150		3.18	3.81
L ₂	0.000	0.030		0.000	0.76
a	0°	15°	4	0°	15°
N	16		5	16	
N ₁	0		6	0	
Q ₁	0.050	0.085		1.27	2.15
S	0.015	0.060		0.39	1.52

92SS-4266R5

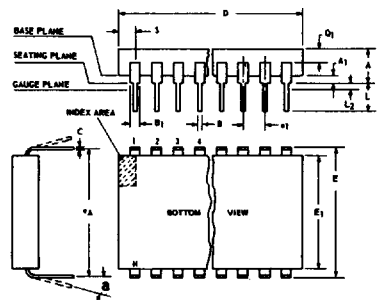

- NOTES:**
Refer to Rules for Dimensioning (JEDEC Publication No. 95) for Axial Lead Product Outlines.
- When this device is supplied solder-dipped, the maximum lead thickness (narrow portion) will not exceed 0.013" (0.33 mm).
 - Leads within 0.005" (0.12 mm) radius of True Position (TP) at gauge plane with maximum material condition and unit installed.
 - e_A applies in zone L₂ when unit installed.
 - a applies to spread leads prior to installation.
 - N is the maximum quantity of lead positions.
 - N₁ is the quantity of allowable missing leads.

(D) SUFFIX (JEDEC MO-015-AG)
24-Lead Dual-In-Line Welded-Seal Ceramic Package

SYMBOL	INCHES		NOTE	MILLIMETERS	
	MIN.	MAX.		MIN.	MAX.
A	0.090	0.200		2.29	5.08
A ₁	0.020	0.070		0.51	1.78
B	0.015	0.020		0.381	0.508
B ₁	0.045	0.055		1.143	1.397
C	0.008	0.012	1	0.204	0.304
D	1.15	1.22		29.21	30.98
E	0.600	0.625		15.24	15.87
E ₁	0.480	0.520		12.20	13.20
e ₁	0.100 TP		2	2.54 TP	
e _A	0.600 TP		2, 3	15.24 TP	
L	0.100	0.180		2.54	4.57
L ₂	0.000	0.030		0.00	0.76
a	0°	15°	4	0°	15°
N	24		5	24	
N ₁	0		6	0	
Q ₁	0.020	0.080		0.51	2.03
S	0.020	0.060		0.51	1.52

92CS-19948R4

(D) SUFFIX (JEDEC MO-015-AH)
28-Lead Dual-In-Line Welded-Seal Ceramic Package

SYMBOL	INCHES		NOTE	MILLIMETERS	
	MIN.	MAX.		MIN.	MAX.
A	0.090	0.200		2.29	5
A ₁	0	0.070	2	0	1.77
B	0.015	0.020		0.381	0.508
B ₁	0.015	0.065		0.39	1.39
C	0.008	0.012	1	0.204	0.304
D	1.380	1.420		35.06	36.06
E	0.600	0.625		15.24	15.87
E ₁	0.485	0.515		12.32	13.08
e ₁	0.100 TP		2	2.54 TP	
e _A	0.600 TP		2, 3	15.24 TP	
L	0.100	0.200		2.6	5
L ₂	0	0.030		0	0.76
a	0°	15°	4	0°	15°
N	28		5	28	
N ₁	0		6	0	
Q ₁	0.020	0.070		0.51	1.77
S	0.040	0.070		1.02	1.77

92CM-20250R2

TO-5 Style Package

(T) SUFFIX (JEDEC MO-006-AG)
12-Lead Metal Package

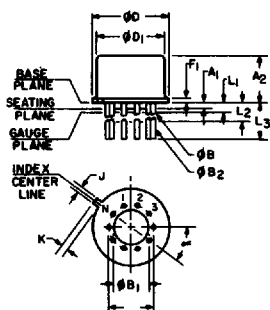

92CS-19774

SYMBOL	INCHES		NOTE	MILLIMETERS	
	MIN.	MAX.		MIN.	MAX.
a	0.230		2	5.84 TP	
A ₁	0	0		0	0
A ₂	0.165	0.185		4.19	4.70
φB	0.016	0.019	3	0.407	0.482
φB ₁	0	0		0	0
φB ₂	0.016	0.021	3	0.407	0.533
φD	0.335	0.370		8.51	9.39
φD ₁	0.305	0.335		7.75	8.50
F ₁	0.020	0.040		0.51	1.01
j	0.028	0.034		0.712	0.863
k	0.029	0.045	4	0.74	1.14
L ₁	0.000	0.050	3	0.00	1.27
L ₂	0.250	0.500	3	6.4	12.7
L ₃	0.500	0.562	3	12.7	14.27
a	30° TP			30° TP	
N	12		6	12	
N ₁	1		5	1	

NOTES:

- Refer to Rules for Dimensioning Axial Lead Product Outlines.
- Leads at gauge plane within 0.007" (0.178 mm) radius of True Position (TP) at maximum material condition.
- φB applies between L₁ and L₂. φB₂ applies between L₂ and 0.500" (12.70 mm) from seating plane. Diameter is uncontrolled in L₁ and beyond 0.500" (12.70 mm).
- Measure from Max. φD.
- N₁ is the quantity of allowable missing leads.
- N is the maximum quantity of lead positions.

Dimensional Outlines (Cont'd)

DUAL-IN-LINE SIDE-BRAZED CERAMIC PACKAGES

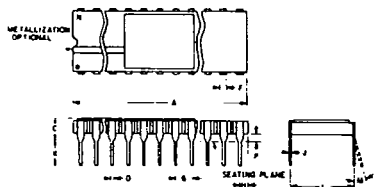

(D) SUFFIX
18-Lead Dual-In-Line
Side-Brazed Ceramic Package

SYMBOL	INCHES		NOTE	MILLIMETERS	
	MIN.	MAX.		MIN.	MAX.
A	0.890	0.915		22.606	23.241
C	—	0.200		—	5.080
D	0.015	0.021		0.381	0.533
F	0.054	REF.	1	1.371	REF.
G	0.100	BSC	1	2.54	BSC
H	0.035	0.065		0.889	1.651
J	0.008	0.012	3	0.203	0.304
K	0.125	0.150		3.175	3.810
L	0.290	0.310	2	7.366	7.874
M	—	15°		0°	15°
P	0.025	0.045		0.635	1.143
N	18			18	

92CS-27231R1

(D) SUFFIX
22-Lead Dual-In-Line
Side-Brazed Ceramic Package

SYMBOL	INCHES		NOTE	MILLIMETERS	
	MIN.	MAX.		MIN.	MAX.
A	1.065	1.100		27.05	27.94
C	0.085	0.145		2.16	3.68
D	0.017	0.023		0.43	0.58
F	0.040	REF.	1	1.02	REF.
G	0.100	BSC	1	2.54	BSC
H	0.030	0.070		0.76	1.78
J	0.008	0.012	3	0.20	0.30
K	0.125	0.175		3.18	4.45
L	0.380	0.420	2	9.65	10.67
M	—	7°		—	7°
P	0.025	0.050		0.64	1.27
N	22			22	

92CS-25186R2

NOTES:

- Leads within 0.005" (0.13 mm)-radius of True Position at maximum material condition.
- Dimension "L" to center of leads when formed parallel.
- When this device is supplied solder-dipped, the maximum lead thickness (narrow portion) will not exceed 0.013" (0.33 mm).

(D) SUFFIX
24-Lead Dual-In-Line
Side-Brazed Ceramic Package

SYMBOL	INCHES		NOTE	MILLIMETERS	
	MIN.	MAX.		MIN.	MAX.
A	1.180	1.220		29.98	30.98
C	0.085	0.145		2.16	3.68
D	0.015	0.023		0.39	0.58
F	0.040	REF.		1.02	REF.
G	0.100	BSC	1	2.54	BSC
H	0.030	0.070		0.77	1.77
J	0.008	0.012	3	0.21	0.30
K	0.125	0.175		3.18	4.44
L	0.580	0.620	2	14.74	15.74
M	—	7°		—	7°
P	0.025	0.050		0.64	1.27
N	24			24	

92CS-30968R1

(D) SUFFIX
40-Lead Dual-In-Line
Side-Brazed Ceramic Package

SYMBOL	INCHES		NOTE	MILLIMETERS	
	MIN.	MAX.		MIN.	MAX.
A	1.980	2.020		50.30	51.30
C	0.095	0.155		2.43	3.93
D	0.017	0.023		0.43	0.58
F	0.050	REF.		1.27	REF.
G	0.100	BSC	1	2.54	BSC
H	0.030	0.070		0.76	1.78
J	0.008	0.012	3	0.20	0.30
K	0.125	0.175		3.18	4.45
L	0.580	0.620	2	14.74	15.74
M	—	7°		—	7°
P	0.025	0.050		0.64	1.27
N	40			40	

92CM-27029R2

Dual-In-Line Plastic and Frit-Seal Ceramic Packages

(E) SUFFIX (JEDEC MO-001-AN)
8-Lead Dual-In-Line Plastic
(Mini-DIP) Package

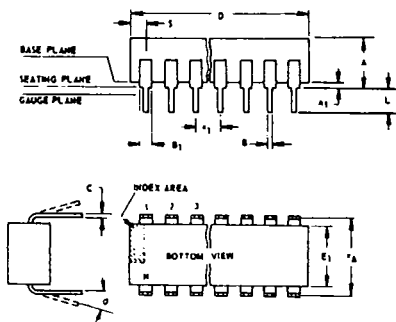

SYMBOL	INCHES		NOTE	MILLIMETERS	
	MIN.	MAX.		MIN.	MAX.
A	0.155	0.200		3.94	5.08
A ₁	0.020	0.050		0.508	1.27
B	0.014	0.020		0.356	0.508
B ₁	0.035	0.065		0.889	1.65
C	0.008	0.012	1	0.203	0.304
D	0.370	0.400		9.40	10.16
E	0.300	0.325		7.62	8.25
E ₁	0.240	0.260		6.10	6.60
e ₁	0.100	TP	2	2.54	TP
e _A	0.300	TP	2, 3	7.62	TP
L	0.125	0.150		3.18	3.81
L ₂	0.000	0.030		0.000	0.762
a	0	15	4	0	15
N	8		5	8	
N ₁	0		6	0	
O ₁	0.040	0.075		1.02	1.90
S	0.015	0.060		0.381	1.52

92CS-24026 R1

NOTES:

- Refer to Rules for Dimensioning (JEDEC Publication No. 95) for Axial Lead Product Outlines.
- When this device is supplied solder-dipped, the maximum lead thickness (narrow portion) will not exceed 0.013".
 - Leads within 0.005" (0.12 mm) radius of True Position (TP) at gauge plane with maximum material condition and unit installed.
 - e_A applies in zone L₂ when unit installed.
 - a applies to spread leads prior to installation.
 - N is the maximum quantity of lead positions.
 - N₁ is the quantity of allowable missing leads.

Dimensional Outlines (Cont'd)

Dual-In-Line Plastic and Frit-Seal Ceramic Packages (Cont'd)

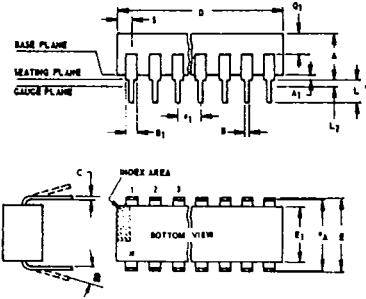

NOTES:
 Refer to Rules for Dimensioning (JEDEC Publication No. 95) for Axial Lead Product Outlines.
 1. When this device is supplied solder dipped, the maximum lead thickness (narrow portion) will not exceed 0.013" (0.33 mm).
 2. Leads within 0.005" (0.12 mm) radius of True Position (TP) at gauge plane with maximum material condition and unit installed.
 3. eA applies in zone L2 when unit installed.
 4. a applies to spread leads prior to installation.
 5. N is the maximum quantity of lead positions.
 6. N1 is the quantity of allowable missing leads.

(E) and (F) SUFFIXES (JEDEC MO-001-AB)
 14-Lead Dual-In-Line Plastic or Frit-Seal Ceramic Package

SYMBOL	INCHES		NOTE	MILLIMETERS	
	MIN.	MAX.		MIN.	MAX.
A	0.155	0.200		3.94	5.08
A1	0.020	0.050		0.51	1.27
B	0.014	0.020		0.356	0.508
B1	0.050	0.065		1.27	1.65
C	0.008	0.012	1	0.204	0.304
D	0.745	0.770		18.93	19.55
E	0.300	0.325		7.62	8.25
E1	0.240	0.260		6.10	6.60
e1	0.100 TP		2	2.54 TP	
eA	0.300 TP		2,3	7.62 TP	
L	0.125	0.150		3.18	3.81
L2	0.000	0.030		0.000	0.76
a	0°	15°	4	0°	15°
N	14		5	14	
N1	0		6	0	
Q1	0.040	0.075		1.02	1.90
S	0.065	0.090		1.66	2.28

92SS-4296R3

(E) and (F) SUFFIXES (JEDEC MO-001-AC)
 16-Lead Dual-In-Line Plastic or Frit-Seal Ceramic Package

SYMBOL	INCHES		NOTE	MILLIMETERS	
	MIN.	MAX.		MIN.	MAX.
A	0.155	0.200		3.94	5.08
A1	0.020	0.050		0.51	1.27
B	0.014	0.020		0.356	0.508
B1	0.035	0.065		0.89	1.65
C	0.008	0.012	1	0.204	0.304
D	0.745	0.785		18.93	19.93
E	0.300	0.325		7.62	8.25
E1	0.240	0.260		6.10	6.60
e1	0.100 TP		2	2.54 TP	
eA	0.300 TP		2,3	7.62 TP	
L	0.125	0.150		3.18	3.81
L2	0.000	0.030		0.000	0.76
a	0°	15°	4	0°	15°
N	16		5	16	
N1	0		6	0	
Q1	0.040	0.075		1.02	1.90
S	0.015	0.060		0.39	1.52

92CM-15967R4

(E) SUFFIX
 18-Lead Dual-In-Line Plastic Package

SYMBOL	INCHES		NOTE	MILLIMETERS	
	MIN.	MAX.		MIN.	MAX.
A	0.155	0.200		3.94	5.08
A1	0.020	0.050		0.508	1.27
B	0.014	0.020		0.356	0.508
B1	0.035	0.065		0.89	1.65
C	0.008	0.012	1	0.204	0.304
D	0.845	0.885		21.47	22.47
E1	0.240	0.260		6.10	6.60
e1	0.100 TP		2	2.54 TP	
eA	0.300 TP		2,3	7.62 TP	
L	0.125	0.150		3.18	3.81
L2	0	0.030		0	0.762
a	0°	15°	4	0°	15°
N	18		5	18	
N1	0		6	0	
S	0.015	0.060		0.39	1.52

92CS-30630

(E) SUFFIX
 22-Lead Dual-In-Line Plastic Package

SYMBOL	INCHES		NOTE	MILLIMETERS	
	MIN.	MAX.		MIN.	MAX.
A	0.155	0.200		3.94	5.08
A1	0.020	0.050		0.508	1.27
B	0.015	0.020		0.381	0.508
B1	0.035	0.065		0.89	1.65
C	0.008	0.012	1	0.204	0.304
D		1.120			28.44
E	0.390	0.420		9.91	10.66
E1	0.345	0.355		8.77	9.01
e1	0.100 TP		2	2.54 TP	
eA	0.400 TP		2,3	10.16 TP	
L	0.125	0.150		3.18	3.81
L2	0	0.030		0	0.762
a	2°	15°	4	2°	15°
N	22		5	22	
N1	0		6	0	
Q1	0.055	0.085		1.40	2.15
S	0.015	0.060		0.381	1.27

92CS-30830

(F) SUFFIX (JEDEC MO-001-AG)
 16-Lead Dual-In-Line Frit-Seal Ceramic Package

SYMBOL	INCHES		NOTE	MILLIMETERS	
	MIN.	MAX.		MIN.	MAX.
A	0.165	0.210		4.20	5.33
A1	0.015	0.045		0.381	1.14
B	0.015	0.020		0.381	0.508
B1	0.045	0.070		1.15	1.77
C	0.009	0.011	1	0.229	0.279
D	0.750	0.795		19.05	20.19
E	0.295	0.325		7.50	8.25
E1	0.245	0.300		6.23	7.62
e1	0.100 TP		2	2.54 TP	
eA	0.300 TP		2,3	7.62 TP	
L	0.120	0.160		3.05	4.06
L2	0.000	0.030		0.000	0.76
a	2°	15°	4	2°	15°
N	16		5	16	
N1	0		6	0	
Q1	0.050	0.080		1.27	2.03
S	0.010	0.060		0.254	1.52

92CM-22284R1

(E) and (F) SUFFIXES (JEDEC MO-015-AA)
 24-Lead Dual-In-Line Plastic or Frit-Seal Ceramic Package

SYMBOL	INCHES		NOTE	MILLIMETERS	
	MIN.	MAX.		MIN.	MAX.
A	0.120	0.250		3.10	6.30
A1	0.020	0.070		0.51	1.77
B	0.016	0.020		0.407	0.508
B1	0.028	0.070		0.72	1.77
C	0.008	0.012	1	0.204	0.304
D	1.20	1.29		30.48	32.76
E	0.600	0.625		15.24	15.87
E1	0.515	0.580		13.09	14.73
e1	0.100 TP		2	2.54 TP	
eA	0.600 TP		2,3	15.24 TP	
L	0.100	0.200		2.54	5.00
L2	0.000	0.030		0.00	0.76
a	0°	15°	4	0°	15°
N	24		5	24	
N1	0		6	0	
Q1	0.040	0.075		1.02	1.90
S	0.040	0.100		1.02	2.54

92CS26938R2

(E) SUFFIX
 40-Lead Dual-In-Line Plastic Package

SYMBOL	INCHES		NOTE	MILLIMETERS	
	MIN.	MAX.		MIN.	MAX.
A	0.120	0.250		3.10	6.30
A1	0.020	0.070		0.51	1.77
B	0.016	0.020		0.407	0.508
B1	0.028	0.070		0.72	1.77
C	0.008	0.012	1	0.204	0.304
D	2.000	2.090		50.80	53.09
E1	0.515	0.580		13.09	14.73
e1	0.100 TP		2	2.54 TP	
eA	0.600 TP		2,3	15.24 TP	
L	0.100	0.200		2.54	5.00
L2	0.000	0.030		0.00	0.76
a	0°	15°	4	0°	15°
N	40		5	40	
N1	0		6	0	
Q1	0.065	0.095		1.66	2.41
S	0.040	0.100		1.02	2.54

92CS-30959

T-90-20

Dimensional Outlines (Cont'd)

Ceramic Flat Packs

**(K) SUFFIX (JEDEC MO-004-AF)
14-Lead**

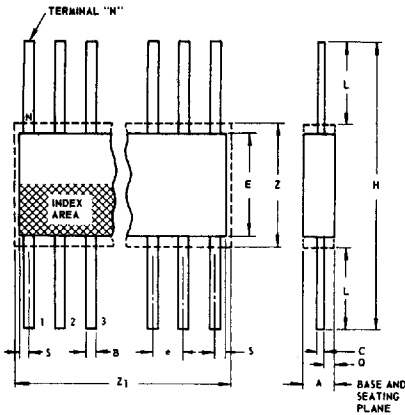

SYMBOL	INCHES		NOTE	MILLIMETERS	
	MIN.	MAX.		MIN.	MAX.
A	0.008	0.100		0.21	2.54
B	0.015	0.019	1	0.381	0.482
C	0.003	0.006	1	0.077	0.152
e	0.050 TP		2	1.27 TP	
E	0.200	0.300		5.1	7.6
H	0.600	1.000		15.3	25.4
L	0.150	0.350		3.9	8.8
N	14		3	14	
Q	0.005	0.050		0.13	1.27
S	0.000	0.050		0.00	1.27
Z	0.300		4	7.62	
Z ₁	0.400		4	10.16	

9288-4300R3

NOTES:

1. Refer to JEDEC Publication No. 95 for Rules for Dimensioning Peripheral Lead Outlines.
2. Leads within 0.005" (0.12 mm) radius of True Position (TP) at maximum material condition.
3. N is the maximum quantity of lead positions.
4. Z and Z₁ determine a zone within which all body and lead irregularities lie.

**(K) SUFFIX (JEDEC MO-004-AG)
16-Lead**

SYMBOL	INCHES		NOTE	MILLIMETERS	
	MIN.	MAX.		MIN.	MAX.
A	0.008	0.100		0.21	2.54
B	0.015	0.019	1	0.381	0.482
C	0.003	0.006	1	0.077	0.152
e	0.050 TP		2	1.27 TP	
E	0.200	0.300		5.1	7.6
H	0.600	1.000		15.3	25.4
L	0.150	0.350		3.9	8.8
N	16		3	16	
Q	0.005	0.050		0.13	1.27
S	0.000	0.025		0.00	0.63
Z	0.300		4	7.62	
Z ₁	0.400		4	10.16	

92CS-17271R3

**(K) SUFFIX
24-Lead**

SYMBOL	INCHES		NOTE	MILLIMETERS	
	MIN.	MAX.		MIN.	MAX.
A	0.075	0.120		1.91	3.04
B	0.018	0.022	1	0.458	0.558
C	0.004	0.007	1	0.102	0.177
e	0.050 TP		2	1.27 TP	
E	0.600	0.700		15.24	17.78
H	1.150	1.350		29.21	34.29
L	0.225	0.325		5.72	8.25
N	24		3	24	
Q	0.035	0.070		0.89	1.77
S	0.060	0.110	1	1.53	2.79
Z	0.700		4	17.78	
Z ₁	0.750		4	19.05	

92CS-19949R2

**(K) SUFFIX
28-Lead**

SYMBOL	INCHES		NOTE	MILLIMETERS	
	MIN.	MAX.		MIN.	MAX.
A	0.075	0.120		1.91	3.04
B	0.018	0.022	1	0.458	0.558
C	0.004	0.007	1	0.102	0.177
e	0.050 TP		2	1.27 TP	
E	0.600	0.700		15.24	17.78
H	1.150	1.350		29.21	34.29
L	0.225	0.325		5.72	8.25
N	28		3	28	
Q	0.035	0.070		0.89	1.77
S	0	0.060	1	0	1.53
Z	0.700		4	17.78	
Z ₁	0.750		4	19.05	

92CS-20972