

Data sheet | Item number: 859-738

Optocoupler module; Nominal input voltage: 5 VDC

[www.wago.com/859-738](http://www.wago.com/859-738)

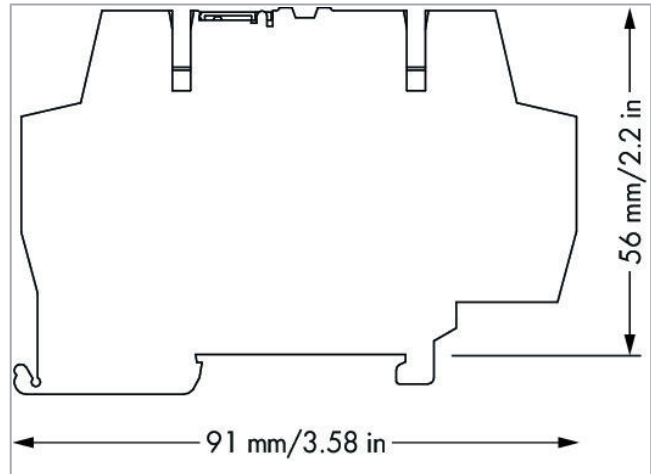
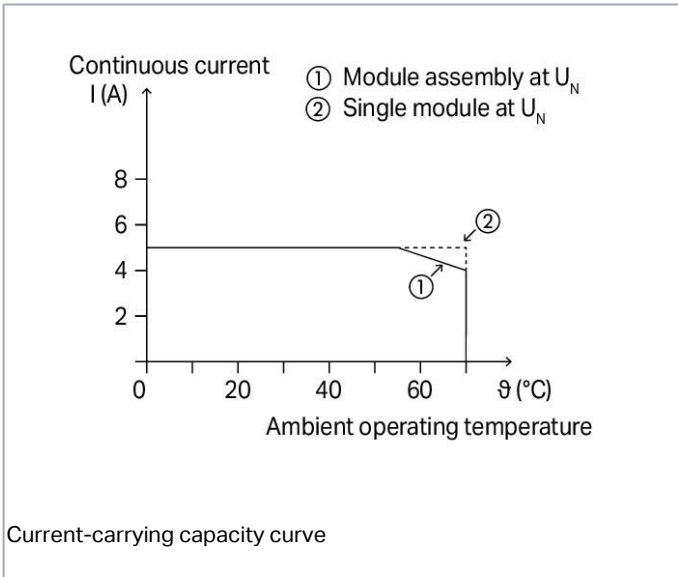
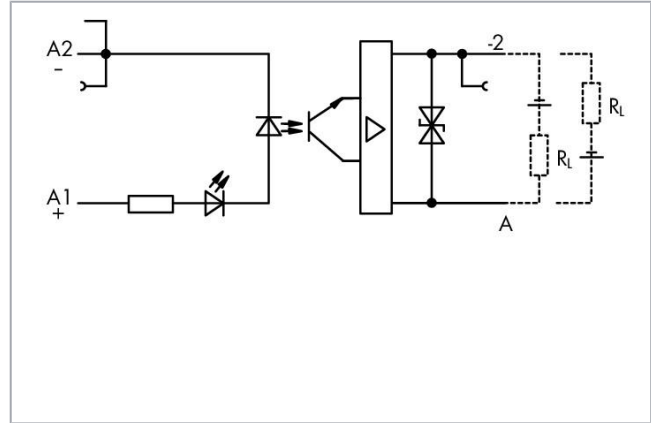
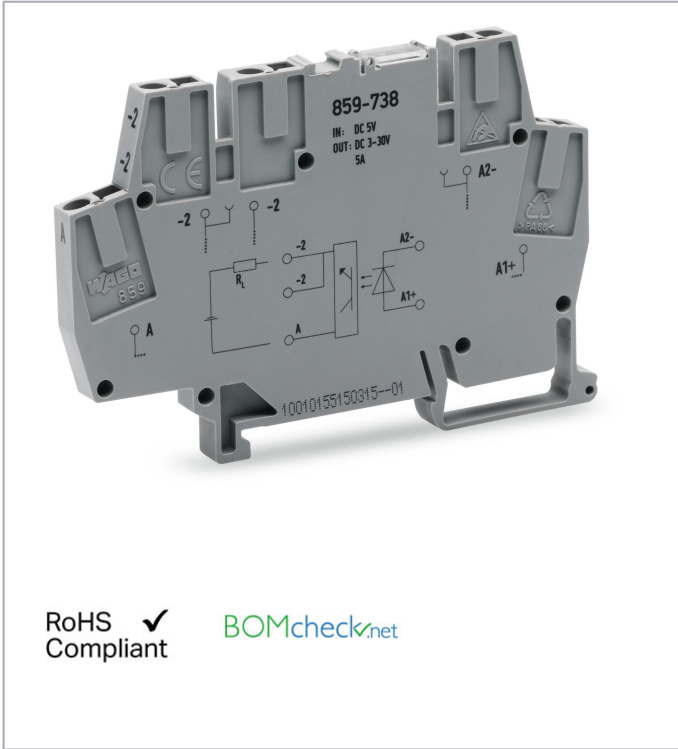

Subject to changes. Please also observe the further product documentation!

WAGO Kontakttechnik GmbH & Co. KG  
Hansastr. 27  
32423 Minden  
Phone: +49571 887-0 | Fax: +49571 887-169  
Email: [info.de@wago.com](mailto:info.de@wago.com) | Web: [www.wago.com](http://www.wago.com)

Do you have any questions about our products?  
We are always happy to take your call at +49 (571) 887-44222.



## Item description

### Note:

Optocouplers and solid state relays are designed for use in signal processing networks, which are not supplied by the low-voltage power supply networks.

## Data

### Technical Data

#### Control circuit

Nominal input voltage $U_N$	DC 5 V (SELV)
Input voltage range (low level)	DC 0 ... 2 V
Input voltage range (high level)	DC 4 ... 6 V
Nominal input current at $U_N$	7.2 mA

#### Load circuit

Circuit type	2-wire connection
Limiting continuous current	5 A
Peak output current	25 A
Nominal output voltage	DC 24 V
Output voltage range	DC 3 ... 30 V
Voltage drop at output (max.)	≤ DC 0.2 V
Turn-on time	≤ 200 μs
Turn-off time	≤ 450 μs
Switching frequency	≤ 100 Hz

#### Signaling

Status indicator	Red LED
------------------	---------

#### Safety and protection

Rated voltage	300 V
Overvoltage category	II
Pollution degree	2
Dielectric strength, control/load circuit (AC, 1 min)	2.5 kVrms
Insulation type (control/load circuit)	Basic insulation
Insulation type (adjacent devices)	Reinforced insulation (safe isolation)

Subject to changes. Please also observe the further product documentation!



## Connection data

Connection technology	CAGE CLAMP®
Solid conductor	0.08 ... 2.5 mm <sup>2</sup> / 28 ... 14 AWG
Fine-stranded conductor	0.08 ... 2.5 mm <sup>2</sup> / 28 ... 14 AWG
Strip length	5 ... 6 mm / 0.2 ... 0.24 inch

## Physical data

Width	6 mm / 0.236 inch
Height from upper-edge of DIN-rail	56 mm / 2.205 inch
Depth	91 mm / 3.583 inch

## Mechanical data

Mounting type	DIN-35 rail
---------------	-------------

## Material Data

Fire load	0.313 MJ
Weight	18.9 g

## Environmental Requirements

Surrounding air temperature (operation at U <sub>N</sub> )	-25 ... 70 °C
Surrounding air temperature (storage)	-40 ... 70 °C
Processing temperature	-25 ... +50 °C

## Standards and specifications

Standards/specifications	EN 61010-2-201; EN 61000-6-2; EN 61000-6-3; EN 61373
--------------------------	--

## Commercial data

Product Group	6 (Interface Electronics)
Packaging type	BOX
Country of origin	DE
GTIN	4055143605359
Customs tariff number	85365005000

Subject to changes. Please also observe the further product documentation!

WAGO Kontakttechnik GmbH & Co. KG  
 Hansastr. 27  
 32423 Minden  
 Phone: +49571 887-0 | Fax: +49571 887-169  
 Email: [info.de@wago.com](mailto:info.de@wago.com) | Web: [www.wago.com](http://www.wago.com)

Do you have any questions about our products?  
 We are always happy to take your call at +49 (571) 887-44222.

## Counterpart

## Compatible products

## tools

**Item no.: 210-720**

Operating tool; Blade: 3.5 x 0.5 mm; with a partially insulated shaft

[www.wago.com/210-720](http://www.wago.com/210-720)

## check

**Item no.: 859-500**

Test pin; 1 mm Ø; with solder connection for test wire

[www.wago.com/859-500](http://www.wago.com/859-500)

## Jumper

**Item no.: 859-402**

Jumper; for jumper slot; 2-way; insulated; light gray

[www.wago.com/859-402](http://www.wago.com/859-402)**Item no.: 859-402/000-005**

Jumper; for jumper slot; 2-way; insulated; red

[www.wago.com/859-402/000-005](http://www.wago.com/859-402/000-005)**Item no.: 859-402/000-006**

Jumper; for jumper slot; 2-way; insulated; blue

[www.wago.com/859-402/000-006](http://www.wago.com/859-402/000-006)**Item no.: 859-402/000-029**

Jumper; for jumper slot; 2-way; insulated; yellow

[www.wago.com/859-402/000-029](http://www.wago.com/859-402/000-029)**Item no.: 859-403**

Jumper; for jumper slot; 3-way; insulated; light gray

[www.wago.com/859-403](http://www.wago.com/859-403)**Item no.: 859-403/000-005**

Jumper; for jumper slot; 3-way; insulated; red

[www.wago.com/859-403/000-005](http://www.wago.com/859-403/000-005)**Item no.: 859-403/000-006**

Jumper; for jumper slot; 3-way; insulated; blue

[www.wago.com/859-403/000-006](http://www.wago.com/859-403/000-006)**Item no.: 859-403/000-029**

Jumper; for jumper slot; 3-way; insulated; yellow

[www.wago.com/859-403/000-029](http://www.wago.com/859-403/000-029)**Item no.: 859-404**

Jumper; for jumper slot; 4-way; insulated; light gray

[www.wago.com/859-404](http://www.wago.com/859-404)

Subject to changes. Please also observe the further product documentation!

WAGO Kontakttechnik GmbH &amp; Co. KG

Hansastr. 27

32423 Minden

Phone: +49571 887-0 | Fax: +49571 887-169













Email: [info.de@wago.com](mailto:info.de@wago.com) | Web: [www.wago.com](http://www.wago.com)

Do you have any questions about our products?





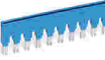









We are always happy to take your call at +49 (571) 887-44222.

	<b>Item no.: 859-404/000-005</b> Jumper; for jumper slot; 4-way; insulated; red	<a href="http://www.wago.com/859-404/000-005">www.wago.com/859-404/000-005</a>
	<b>Item no.: 859-404/000-006</b> Jumper; for jumper slot; 4-way; insulated; blue	<a href="http://www.wago.com/859-404/000-006">www.wago.com/859-404/000-006</a>
	<b>Item no.: 859-404/000-029</b> Jumper; for jumper slot; 4-way; insulated; yellow	<a href="http://www.wago.com/859-404/000-029">www.wago.com/859-404/000-029</a>
	<b>Item no.: 859-405</b> Jumper; for jumper slot; 5-way; insulated; light gray	<a href="http://www.wago.com/859-405">www.wago.com/859-405</a>
	<b>Item no.: 859-405/000-005</b> Jumper; for jumper slot; 5-way; insulated; red	<a href="http://www.wago.com/859-405/000-005">www.wago.com/859-405/000-005</a>
	<b>Item no.: 859-405/000-006</b> Jumper; for jumper slot; 5-way; insulated; blue	<a href="http://www.wago.com/859-405/000-006">www.wago.com/859-405/000-006</a>
	<b>Item no.: 859-405/000-029</b> Jumper; for jumper slot; 5-way; insulated; yellow	<a href="http://www.wago.com/859-405/000-029">www.wago.com/859-405/000-029</a>
	<b>Item no.: 859-406</b> Jumper; for jumper slot; 6-way; insulated; light gray	<a href="http://www.wago.com/859-406">www.wago.com/859-406</a>
	<b>Item no.: 859-406/000-005</b> Jumper; for jumper slot; 6-way; insulated; red	<a href="http://www.wago.com/859-406/000-005">www.wago.com/859-406/000-005</a>
	<b>Item no.: 859-406/000-006</b> Jumper; for jumper slot; 6-way; insulated; blue	<a href="http://www.wago.com/859-406/000-006">www.wago.com/859-406/000-006</a>
	<b>Item no.: 859-406/000-029</b> Jumper; for jumper slot; 6-way; insulated; signal yellow	<a href="http://www.wago.com/859-406/000-029">www.wago.com/859-406/000-029</a>
	<b>Item no.: 859-407</b> Jumper; for jumper slot; 7-way; insulated; light gray	<a href="http://www.wago.com/859-407">www.wago.com/859-407</a>
	<b>Item no.: 859-407/000-005</b> Jumper; for jumper slot; 7-way; insulated; red	<a href="http://www.wago.com/859-407/000-005">www.wago.com/859-407/000-005</a>
	<b>Item no.: 859-407/000-006</b> Jumper; for jumper slot; 7-way; insulated; blue	<a href="http://www.wago.com/859-407/000-006">www.wago.com/859-407/000-006</a>

Subject to changes. Please also observe the further product documentation!

	<b>Item no.: 859-407/000-029</b> Jumper; for jumper slot; 7-way; insulated; yellow	<a href="http://www.wago.com/859-407/000-029">www.wago.com/859-407/000-029</a>
	<b>Item no.: 859-408</b> Jumper; for jumper slot; 8-way; insulated; light gray	<a href="http://www.wago.com/859-408">www.wago.com/859-408</a>
	<b>Item no.: 859-408/000-005</b> Jumper; for jumper slot; 8-way; insulated; red	<a href="http://www.wago.com/859-408/000-005">www.wago.com/859-408/000-005</a>
	<b>Item no.: 859-408/000-006</b> Jumper; for jumper slot; 8-way; insulated; blue	<a href="http://www.wago.com/859-408/000-006">www.wago.com/859-408/000-006</a>
	<b>Item no.: 859-408/000-029</b> Jumper; for jumper slot; 8-way; insulated; yellow	<a href="http://www.wago.com/859-408/000-029">www.wago.com/859-408/000-029</a>
	<b>Item no.: 859-409</b> Jumper; for jumper slot; 9-way; insulated; light gray	<a href="http://www.wago.com/859-409">www.wago.com/859-409</a>
	<b>Item no.: 859-409/000-005</b> Jumper; for jumper slot; 9-way; insulated; red	<a href="http://www.wago.com/859-409/000-005">www.wago.com/859-409/000-005</a>
	<b>Item no.: 859-409/000-006</b> Jumper; for jumper slot; 9-way; insulated; blue	<a href="http://www.wago.com/859-409/000-006">www.wago.com/859-409/000-006</a>
	<b>Item no.: 859-409/000-029</b> Jumper; for jumper slot; 9-way; insulated; yellow	<a href="http://www.wago.com/859-409/000-029">www.wago.com/859-409/000-029</a>
	<b>Item no.: 859-410</b> Jumper; for jumper slot; 10-way; insulated; light gray	<a href="http://www.wago.com/859-410">www.wago.com/859-410</a>
	<b>Item no.: 859-410/000-005</b> Jumper; for jumper slot; 10-way; insulated; red	<a href="http://www.wago.com/859-410/000-005">www.wago.com/859-410/000-005</a>
	<b>Item no.: 859-410/000-006</b> Jumper; for jumper slot; 10-way; insulated; blue	<a href="http://www.wago.com/859-410/000-006">www.wago.com/859-410/000-006</a>
	<b>Item no.: 859-410/000-029</b> Jumper; for jumper slot; 10-way; insulated; yellow	<a href="http://www.wago.com/859-410/000-029">www.wago.com/859-410/000-029</a>
<b>End plate</b>		
	<b>Item no.: 859-525</b> End and intermediate plate; 1 mm thick; gray	<a href="http://www.wago.com/859-525">www.wago.com/859-525</a>
<b>ferrule</b>		

Subject to changes. Please also observe the further product documentation!

	<b>Item no.: 216-221</b> Ferrule; Sleeve for 0.5 mm <sup>2</sup> / 20 AWG; insulated; electro-tin plated; white	<a href="http://www.wago.com/216-221">www.wago.com/216-221</a>
	<b>Item no.: 216-222</b> Ferrule; Sleeve for 0.75 mm <sup>2</sup> / 18 AWG; insulated; electro-tin plated; gray	<a href="http://www.wago.com/216-222">www.wago.com/216-222</a>
	<b>Item no.: 216-223</b> Ferrule; Sleeve for 1 mm <sup>2</sup> / AWG 18; insulated; electro-tin plated; red	<a href="http://www.wago.com/216-223">www.wago.com/216-223</a>
	<b>Item no.: 216-224</b> Ferrule; Sleeve for 1.5 mm <sup>2</sup> / AWG 16; insulated; electro-tin plated; black	<a href="http://www.wago.com/216-224">www.wago.com/216-224</a>
	<b>Item no.: 216-321</b> Ferrule; Sleeve for 0.25 mm <sup>2</sup> / AWG 24; insulated; electro-tin plated; yellow	<a href="http://www.wago.com/216-321">www.wago.com/216-321</a>
	<b>Item no.: 216-322</b> Ferrule; Sleeve for 0.34 mm <sup>2</sup> / 22 AWG; insulated; electro-tin plated; green	<a href="http://www.wago.com/216-322">www.wago.com/216-322</a>
<b>Marking accessories</b>		
	<b>Item no.: 2009-145</b> Mini-WSB Inline; for Smart Printer; 1700 pieces on roll; stretchable 5 - 5.2 mm; plain; snap-on type; white	<a href="http://www.wago.com/2009-145">www.wago.com/2009-145</a>
	<b>Item no.: 2009-145/000-002</b> Mini-WSB Inline; for Smart Printer; 1700 pieces on roll; stretchable 5 - 5.2 mm; plain; snap-on type; yellow	<a href="http://www.wago.com/2009-145/000-002">www.wago.com/2009-145/000-002</a>
	<b>Item no.: 2009-145/000-005</b> Mini-WSB Inline; for Smart Printer; 1700 pieces on roll; stretchable 5 - 5.2 mm; plain; snap-on type; red	<a href="http://www.wago.com/2009-145/000-005">www.wago.com/2009-145/000-005</a>
	<b>Item no.: 2009-145/000-006</b> Mini-WSB Inline; for Smart Printer; 1700 pieces on roll; stretchable 5 - 5.2 mm; plain; snap-on type; blue	<a href="http://www.wago.com/2009-145/000-006">www.wago.com/2009-145/000-006</a>
	<b>Item no.: 2009-145/000-007</b> Mini-WSB Inline; for Smart Printer; 1700 pieces on roll; stretchable 5 - 5.2 mm; plain; snap-on type; gray	<a href="http://www.wago.com/2009-145/000-007">www.wago.com/2009-145/000-007</a>
	<b>Item no.: 2009-145/000-012</b> Mini-WSB Inline; for Smart Printer; 1700 pieces on roll; stretchable 5 - 5.2 mm; plain; snap-on type; orange	<a href="http://www.wago.com/2009-145/000-012">www.wago.com/2009-145/000-012</a>
	<b>Item no.: 2009-145/000-023</b> Mini-WSB Inline; for Smart Printer; 1700 pieces on roll; stretchable 5 - 5.2 mm; plain; snap-on type; green	<a href="http://www.wago.com/2009-145/000-023">www.wago.com/2009-145/000-023</a>
	<b>Item no.: 2009-145/000-024</b> Mini-WSB Inline; for Smart Printer; 1700 pieces on roll; stretchable 5 - 5.2 mm; plain; snap-on type; violet	<a href="http://www.wago.com/2009-145/000-024">www.wago.com/2009-145/000-024</a>
	<b>Item no.: 210-110</b> Fiber-tip pen	<a href="http://www.wago.com/210-110">www.wago.com/210-110</a>

Subject to changes. Please also observe the further product documentation!



**Item no.: 248-501**

Miniature WSB Quick marking system; plain; Marker width 5 mm; 10 strips with 10 markers per card

[www.wago.com/248-501](http://www.wago.com/248-501)



**Item no.: 248-501/000-002**

Mini-WSB marking card; as card; not stretchable; plain; snap-on type; yellow

[www.wago.com/248-501/000-002](http://www.wago.com/248-501/000-002)



**Item no.: 248-501/000-005**

Mini-WSB marking card; as card; not stretchable; plain; snap-on type; red

[www.wago.com/248-501/000-005](http://www.wago.com/248-501/000-005)



**Item no.: 248-501/000-006**

Mini-WSB marking card; as card; not stretchable; plain; snap-on type; blue

[www.wago.com/248-501/000-006](http://www.wago.com/248-501/000-006)



**Item no.: 248-501/000-007**

Mini-WSB marking card; as card; not stretchable; plain; snap-on type; gray

[www.wago.com/248-501/000-007](http://www.wago.com/248-501/000-007)



**Item no.: 248-501/000-012**

Mini-WSB marking card; as card; not stretchable; plain; snap-on type; orange

[www.wago.com/248-501/000-012](http://www.wago.com/248-501/000-012)



**Item no.: 248-501/000-017**

Mini-WSB marking card; as card; not stretchable; plain; snap-on type; light green

[www.wago.com/248-501/000-017](http://www.wago.com/248-501/000-017)



**Item no.: 248-501/000-023**

Mini-WSB marking card; as card; not stretchable; plain; snap-on type; green

[www.wago.com/248-501/000-023](http://www.wago.com/248-501/000-023)



**Item no.: 248-501/000-024**

Mini-WSB marking card; as card; not stretchable; plain; snap-on type; violet

[www.wago.com/248-501/000-024](http://www.wago.com/248-501/000-024)



**Item no.: 248-502**

Mini-WSB marking card; as card; MARKED; 1 ... 10 (10x); not stretchable; Horizontal marking; snap-on type; white

[www.wago.com/248-502](http://www.wago.com/248-502)



**Item no.: 248-502/000-024**

Mini-WSB marking card; as card; MARKED; 1 ... 10 (10x); not stretchable; Horizontal marking; snap-on type; violet

[www.wago.com/248-502/000-024](http://www.wago.com/248-502/000-024)



**Item no.: 248-503**

Mini-WSB marking card; as card; MARKED; 11 ... 20 (10x); not stretchable; Horizontal marking; snap-on type; white

[www.wago.com/248-503](http://www.wago.com/248-503)



**Item no.: 248-503/000-024**

Mini-WSB marking card; as card; MARKED; 11 ... 20 (10x); not stretchable; Horizontal marking; snap-on type; violet

[www.wago.com/248-503/000-024](http://www.wago.com/248-503/000-024)



**Item no.: 248-504**

Mini-WSB marking card; as card; MARKED; 21 ... 30 (10x); not stretchable; Horizontal marking; snap-on type; white

[www.wago.com/248-504](http://www.wago.com/248-504)

Subject to changes. Please also observe the further product documentation!

WAGO Kontakttechnik GmbH & Co. KG

Hansastr. 27

32423 Minden

Phone: +49571 887-0 | Fax: +49571 887-169

Email: [info.de@wago.com](mailto:info.de@wago.com) | Web: [www.wago.com](http://www.wago.com)

Do you have any questions about our products?

We are always happy to take your call at +49 (571) 887-44222.



Item no.: 248-504/000-024

Mini-WSB marking card; as card; MARKED; 21 ... 30 (10x); not stretchable; Horizontal marking; snap-on type; violet

[www.wago.com/248-504/000-024](http://www.wago.com/248-504/000-024)



Item no.: 248-505/000-024

Mini-WSB marking card; as card; MARKED; 31 ... 40 (10x); not stretchable; Horizontal marking; snap-on type; violet

[www.wago.com/248-505/000-024](http://www.wago.com/248-505/000-024)



Item no.: 248-506

Mini-WSB marking card; as card; MARKED; 41 ... 50 (10x); not stretchable; Horizontal marking; snap-on type; white

[www.wago.com/248-506](http://www.wago.com/248-506)

## Downloads

### Documentation

#### Bid Text

859-738 GAEB X81 - Datei	Feb 19, 2019	xml 3.9 kB	Download
859-738 GAEB docx - Datei	Feb 20, 2019	docx 15.6 kB	Download

#### Instruction Leaflet

Relay modules, Optocoupler modules	V 1.2.0 Aug 30, 2019	pdf 2.2 MB	Download
------------------------------------	-------------------------	---------------	----------

#### Additional Information

Disposal; Electrical and electronic equipment, Packaging	V 1.0.0	pdf 265.8 kB	Download
--	---------	-----------------	----------

## CAD/CAE-Data

### CAD data

2D/3D Models 859-738	URL	Download
----------------------	-----	----------

### CAE data

EPLAN Data Portal 859-738	URL	Download
WSCAD Universe 859-738	URL	Download
ZUKEN Portal 859-738	URL	Download

Subject to changes. Please also observe the further product documentation!

WAGO Kontakttechnik GmbH & Co. KG  
 Hansastr. 27  
 32423 Minden  
 Phone: +49571 887-0 | Fax: +49571 887-169  
 Email: [info.de@wago.com](mailto:info.de@wago.com) | Web: [www.wago.com](http://www.wago.com)

Do you have any questions about our products?  
 We are always happy to take your call at +49 (571) 887-44222.

## Installation Notes

### Conductor termination

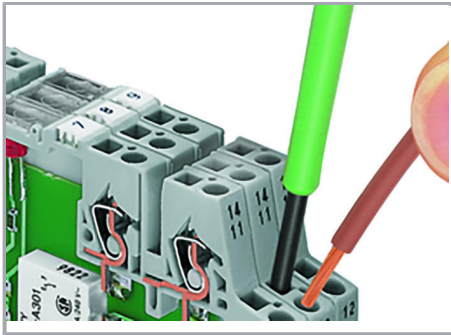

Connection of conductor

### Commoning

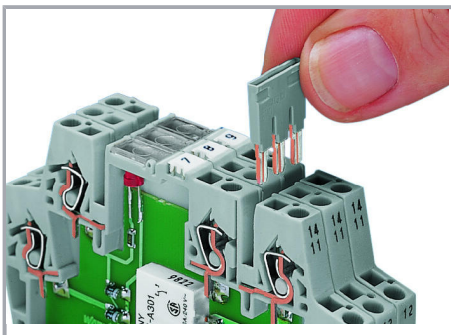

Easy commoning using adjacent jumpers

### Marking

Subject to changes. Please also observe the further product documentation!

WAGO Kontakttechnik GmbH & Co. KG  
Hansastr. 27  
32423 Minden  
Phone: +49571 887-0 | Fax: +49571 887-169  
Email: [info.de@wago.com](mailto:info.de@wago.com) | Web: [www.wago.com](http://www.wago.com)

Do you have any questions about our products?  
We are always happy to take your call at +49 (571) 887-44222.



Marking using miniature WSB quick marking card

Subject to changes. Please also observe the further product documentation!