

FK-MCP 1,5/ 3-STF-3,81 - PCB connector



1851245

<https://www.phoenixcontact.com/us/products/1851245>

Please be informed that the data shown in this PDF document is generated from our Online Catalog. Please find the complete data in the user documentation. Our General Terms of Use for Downloads are valid.

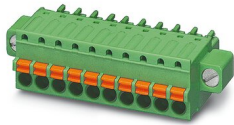

PCB connector, nominal cross section: 1.5 mm², color: green, nominal current: 8 A, rated voltage (III/2): 160 V, contact surface: Tin, type of contact: Socket, number of potentials: 3, number of rows: 1, number of positions: 3, number of connections: 3, product range: FK-MCP 1,5/...-STF, pitch: 3.81 mm, connection method: Push-in spring connection, conductor/PCB connection direction: 0 °, number of solder pins per potential: 1, plug-in system: COMBICON MC 1,5, locking: Screw locking, mounting: Screw flange, type of packaging: packed in cardboard

Your advantages

- Time saving push-in connection, tools not required
- Defined contact force ensures that contact remains stable over the long term
- Intuitive use through colour coded actuation lever
- Screwable flange for superior mechanical stability
- Quick and convenient testing using integrated test option

Commercial Data

Item number	1851245
Packing unit	1 pc
Minimum order quantity	50 pc
Sales Key	AA02
Product Key	AABFNB
Catalog Page	Page 199 (C-1-2013)
GTIN	4017918110291
Weight per Piece (including packing)	3.92 g
Weight per Piece (excluding packing)	3.514 g
Customs tariff number	85366990
Country of origin	DE

Technical Data

Product properties

Type	Standard
Product line	COMBICON Connectors S
Product type	PCB plug
Product family	FK-MCP 1,5/...-STF
Number of positions	3
Pitch	3.81 mm
Number of connections	3
Number of rows	1
Mounting flange	Screw flange
Number of potentials	3
Solder pins per potential	1

Electrical properties

Nominal current I_N	8 A
Nominal voltage U_N	160 V
Degree of pollution	3
Contact resistance	1.4 mΩ
Rated voltage (III/3)	160 V
Rated surge voltage (III/3)	2.5 kV
Rated voltage (III/2)	160 V
Rated surge voltage (III/2)	2.5 kV
Rated voltage (II/2)	320 V
Rated surge voltage (II/2)	2.5 kV

Connection data

Connection technology

Type	Standard
Connector system	COMBICON MC 1,5
Nominal cross section	1.5 mm ²
Type of contact	Socket

Interlock

Locking type	Screw locking
Mounting flange	Screw flange
Tightening torque	0.3 Nm

Conductor connection

Connection method	Push-in spring connection
Conductor/PCB connection direction	0 °
Conductor cross section rigid	0.14 mm ² ... 1.5 mm ²
Conductor cross section flexible	0.14 mm ² ... 1.5 mm ²

FK-MCP 1,5/ 3-STF-3,81 - PCB connector



1851245

<https://www.phoenixcontact.com/us/products/1851245>

Conductor cross section AWG	26 ... 16
Conductor cross section flexible, with ferrule without plastic sleeve	0.25 mm ² ... 1.5 mm ²
Conductor cross section, flexible, with ferrule, with plastic sleeve	0.25 mm ² ... 0.75 mm ²
Cylindrical gauge a x b / diameter	2.4 mm x 1.5 mm / -
Stripping length	9 mm

Specifications for ferrules without insulating collar

recommended crimping tool	1212034 CRIMPFOX 6
ferrules without insulating collar, according to DIN 46228-1	Cross section: 0.25 mm ² ; Length: 7 mm
	Cross section: 0.34 mm ² ; Length: 7 mm
	Cross section: 0.5 mm ² ; Length: 8 mm ... 10 mm
	Cross section: 0.75 mm ² ; Length: 8 mm ... 10 mm
	Cross section: 1 mm ² ; Length: 8 mm ... 10 mm
	Cross section: 1.5 mm ² ; Length: 10 mm

Specifications for ferrules with insulating collar

recommended crimping tool	1212034 CRIMPFOX 6
ferrules with insulating collar, according to DIN 46228-4	Cross section: 0.14 mm ² ; Length: 8 mm
	Cross section: 0.25 mm ² ; Length: 8 mm
	Cross section: 0.34 mm ² ; Length: 8 mm
	Cross section: 0.5 mm ² ; Length: 8 mm ... 10 mm
	Cross section: 0.75 mm ² ; Length: 10 mm

Material specifications

Material data - contact

Note	WEEE/RoHS-compliant, free of whiskers according to IEC 60068-2-82/JEDEC JESD 201
Contact material	Cu alloy
Surface characteristics	hot-dip tin-plated
Metal surface terminal point (top layer)	Tin (4 - 8 μm Sn)
Metal surface contact area (top layer)	Tin (4 - 8 μm Sn)

Material data - housing

Color (Housing)	green (6021)
Insulating material	PA
Insulating material group	I
CTI according to IEC 60112	600
Flammability rating according to UL 94	V0
Glow wire flammability index GWFI according to EN 60695-2-12	850
Glow wire ignition temperature GWIT according to EN 60695-2-13	775
Temperature for the ball pressure test according to EN 60695-10-2	125 °C

Material data – actuating element

FK-MCP 1,5/ 3-STF-3,81 - PCB connector



1851245

<https://www.phoenixcontact.com/us/products/1851245>

Color (Actuating element)	orange (2003)
Insulating material	POM
Insulating material group	I
CTI according to IEC 60112	600
Flammability rating according to UL 94	HB

Dimensions

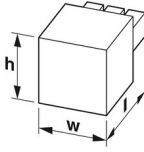
Dimensional drawing	
Pitch	3.81 mm
Width [w]	21.82 mm
Height [h]	12.4 mm
Length [l]	20.8 mm

Mounting

Flange

Tightening torque	0.3 Nm
-------------------	--------

Mechanical tests

Test for conductor damage and slackening

Specification	IEC 60999-1:1999-11
Result	Test passed

Repeated connection and disconnection

Specification	IEC 60999-1:1999-11
Result	Test passed

Pull-out test

Specification	IEC 60999-1:1999-11
Conductor cross section/conductor type/tractive force setpoint/actual value	0.14 mm ² / solid / > 10 N
	0.14 mm ² / flexible / > 10 N
	1.5 mm ² / solid / > 40 N
	1.5 mm ² / flexible / > 40 N

Insertion and withdrawal forces

Result	Test passed
No. of cycles	25
Insertion strength per pos. approx.	8 N
Withdraw strength per pos. approx.	6 N

Contact holder in insert

FK-MCP 1,5/ 3-STF-3,81 - PCB connector



1851245

<https://www.phoenixcontact.com/us/products/1851245>

Specification	IEC 60512-15-1:2008-05
Contact holder in insert Requirements >20 N	Test passed

Resistance of inscriptions

Specification	IEC 60068-2-70:1995-12
Result	Test passed

Polarization and coding

Specification	IEC 60512-13-5:2006-02
Result	Test passed

Visual inspection

Specification	IEC 60512-1-1:2002-02
Result	Test passed

Dimension check

Specification	IEC 60512-1-2:2002-02
Result	Test passed

Environmental and real-life conditions

Vibration test

Specification	IEC 60068-2-6:2007-12
Frequency	10 - 150 - 10 Hz
Sweep speed	1 octave/min
Amplitude	0.35 mm (10 Hz ... 60.1 Hz)
Sweep speed	5g (60.1 Hz ... 150 Hz)
Test duration per axis	2.5 h

Durability test

Specification	IEC 60512-9-1:2010-03
Impulse withstand voltage at sea level	2.95 kV
Contact resistance R ₁	1.4 mΩ
Contact resistance R ₂	1.5 mΩ
Insertion/withdrawal cycles	25

Climatic test

Specification	ISO 6988:1985-02
Corrosive stress	0.2 dm ³ SO ₂ on 300 dm ³ /40 °C/1 cycle
Thermal stress	100 °C/168 h
Power-frequency withstand voltage	1.39 kV

Shocks

Specification	IEC 60068-2-27:2008-02
Pulse shape	Half-sine
Acceleration	30g
Shock duration	18 ms

FK-MCP 1,5/ 3-STF-3,81 - PCB connector



1851245

<https://www.phoenixcontact.com/us/products/1851245>

Test directions	X-, Y- and Z-axis (pos. and neg.)
Ambient conditions	
Ambient temperature (operation)	-40 °C ... 100 °C (dependent on the derating curve)
Ambient temperature (storage/transport)	-40 °C ... 70 °C
Relative humidity (storage/transport)	30 % ... 70 %
Ambient temperature (assembly)	-5 °C ... 100 °C

Electrical tests

Thermal test | Test group C

Specification	IEC 60512-5-1:2002-02
Tested number of positions	20

Insulation resistance

Specification	IEC 60512-3-1:2002-02
Insulation resistance, neighboring positions	> 5 MΩ

Temperature cycles

Specification	IEC 60999-1:1999-11
Result	Test passed

Air clearances and creepage distances |

Specification	IEC 60664-1:2007-04
Insulating material group	I
Comparative tracking index (IEC 60112)	CTI 600
Rated insulation voltage (III/3)	160 V
Rated surge voltage (III/3)	2.5 kV
minimum clearance value - non-homogenous field (III/3)	1.5 mm
minimum creepage distance (III/3)	2 mm
Rated insulation voltage (III/2)	160 V
Rated surge voltage (III/2)	2.5 kV
minimum clearance value - non-homogenous field (III/2)	1.5 mm
minimum creepage distance (III/2)	1.5 mm
Rated insulation voltage (II/2)	320 V
Rated surge voltage (II/2)	2.5 kV
minimum clearance value - non-homogenous field (II/2)	1.5 mm
minimum creepage distance (II/2)	1.6 mm

Packaging specifications

Type of packaging	packed in cardboard
-------------------	---------------------

1851245

<https://www.phoenixcontact.com/us/products/1851245>

Drawings

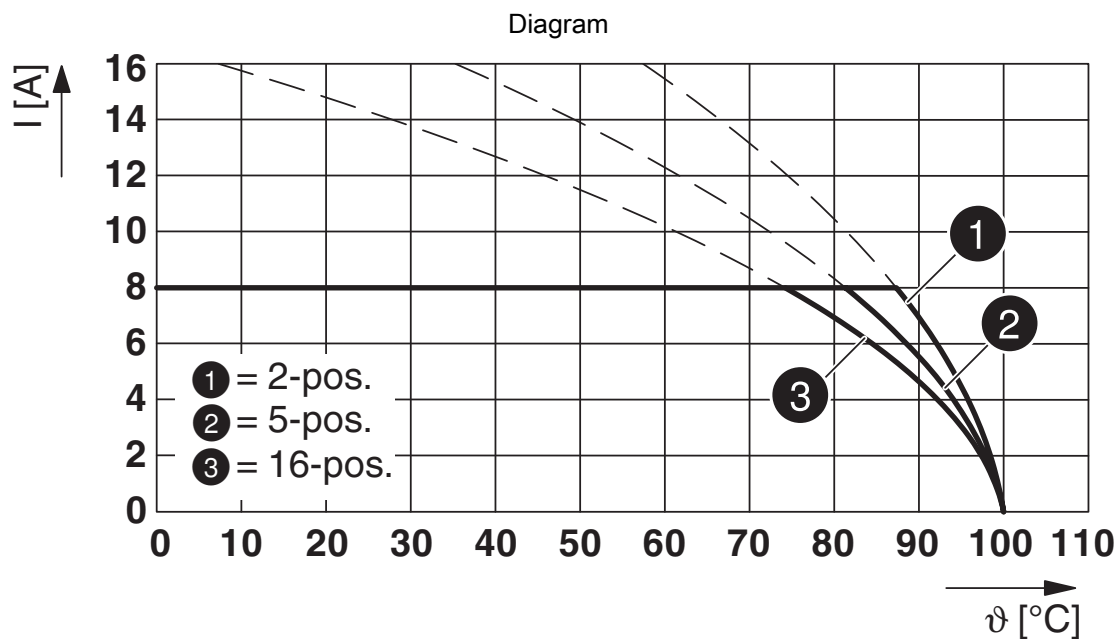

Type: FK-MCP 1,5/...-STF-3,81 with SMC 1,5/...-GF-3,81

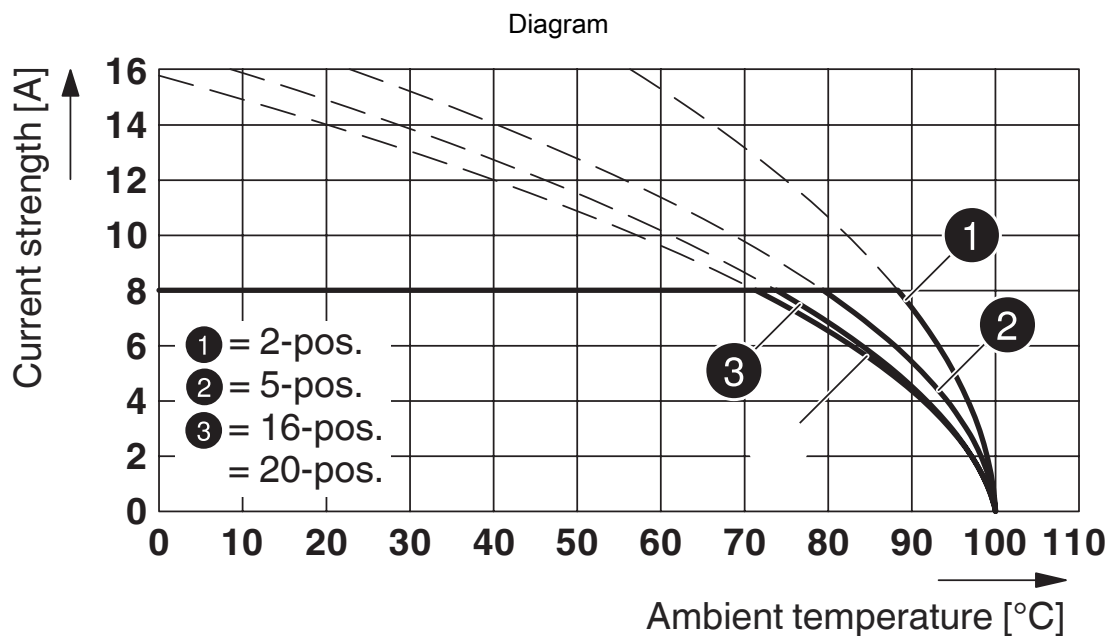

Type: FK-MCP 1,5/...-STF-3,81 with MCV 1,5/...-GF-3,81 P...THR

FK-MCP 1,5/ 3-STF-3,81 - PCB connector



1851245

<https://www.phoenixcontact.com/us/products/1851245>

Dimensional drawing

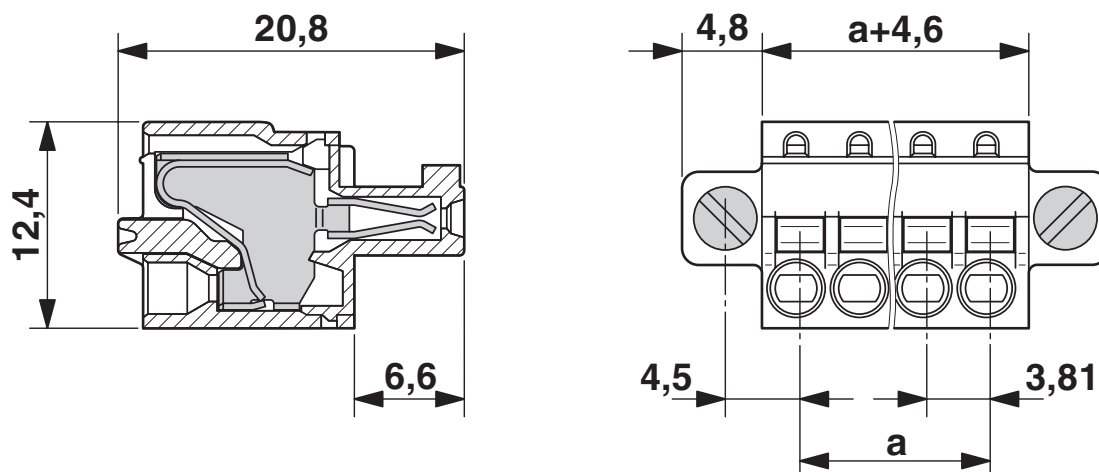

Diagram

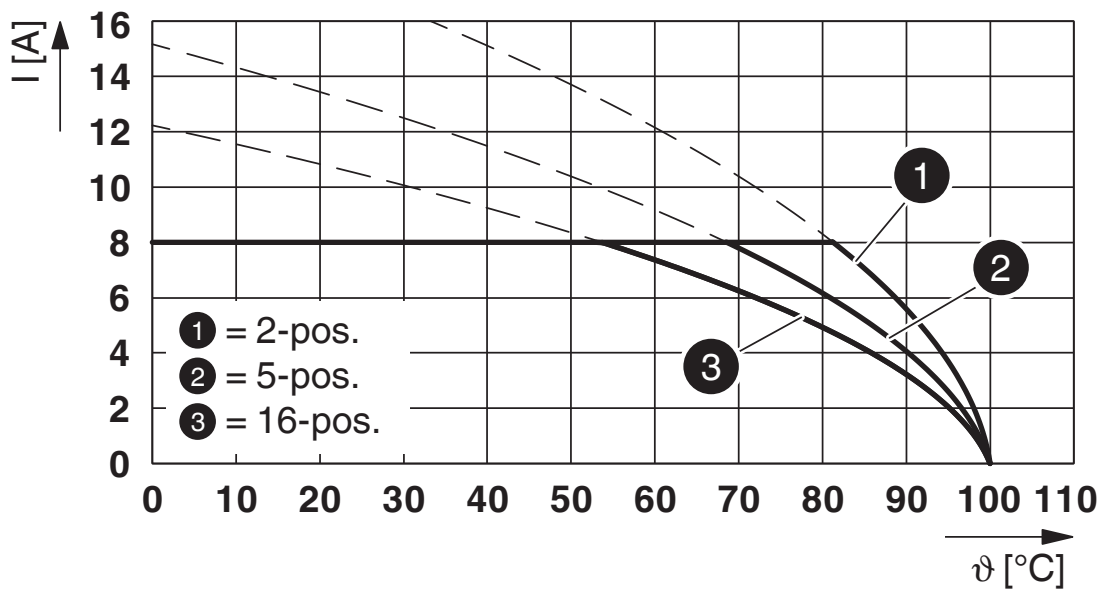

Type: FK-MCP 1,5/...-STF-3,81 with MCD 1,5/...-GF-3,81

1851245

<https://www.phoenixcontact.com/us/products/1851245>

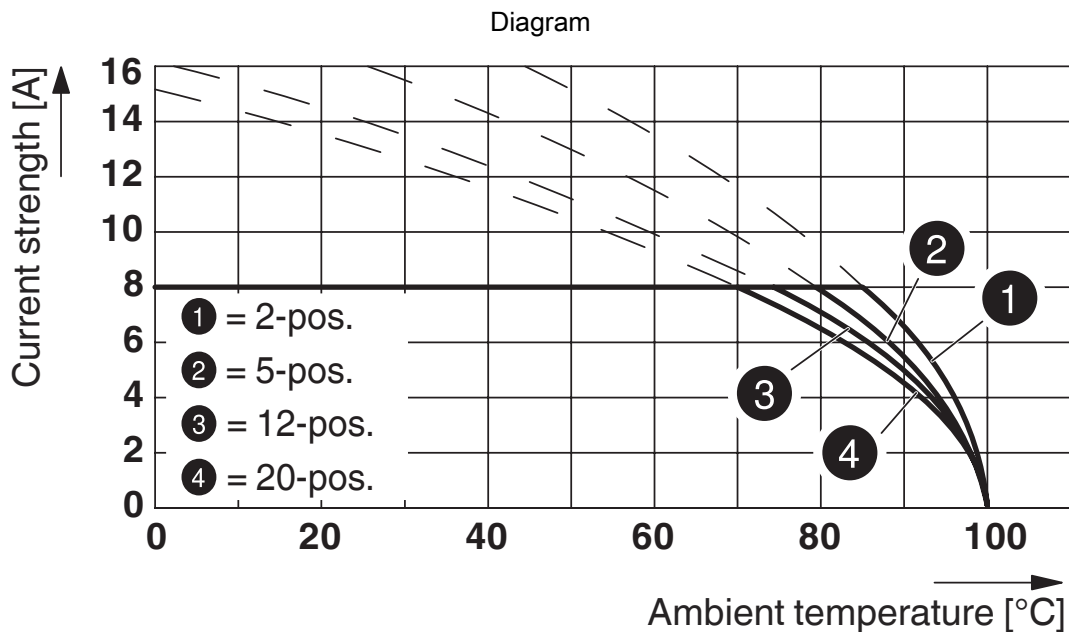

Type: FK-MCP 1,5/...-STF-3,81 with MC 1,5/...-GF-3,81 P... THRR...

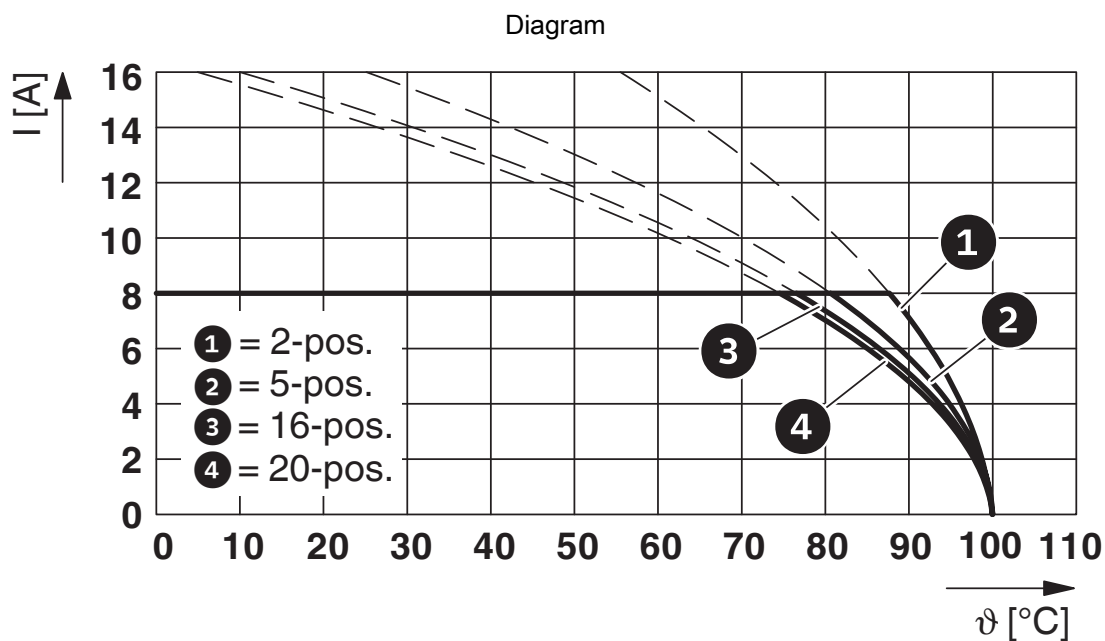

Type: FK-MCP 1,5/...-STF-3,81 with MCV 1,5/...-GF-3,81

1851245

<https://www.phoenixcontact.com/us/products/1851245>

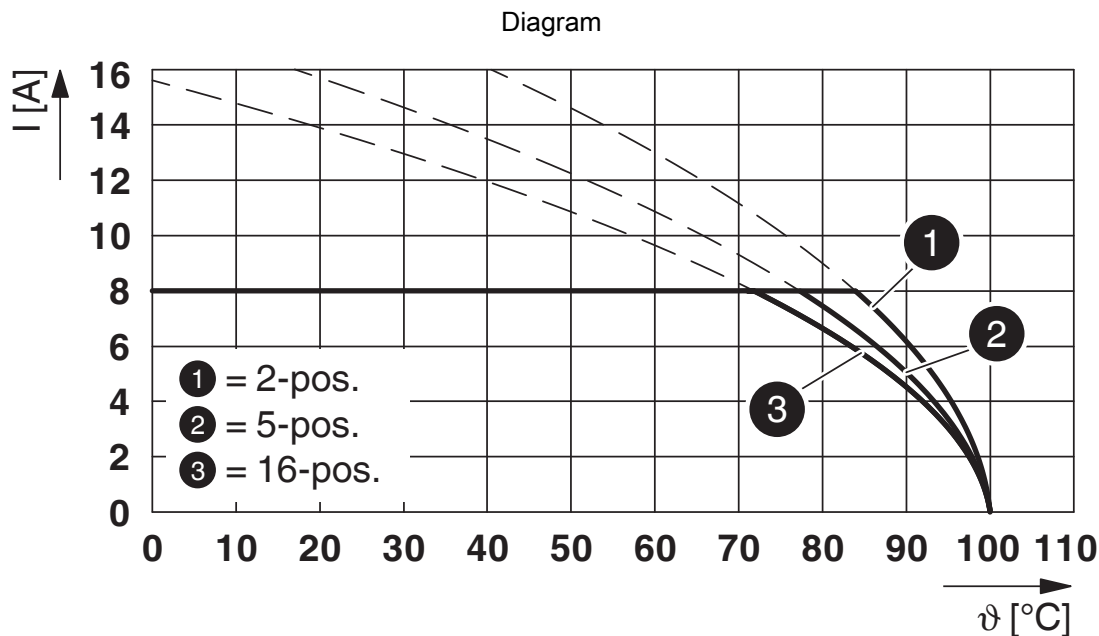

Type: FK-MCP 1,5/...-STF-3,81 with IMC 1,5/...-STGF-3,81

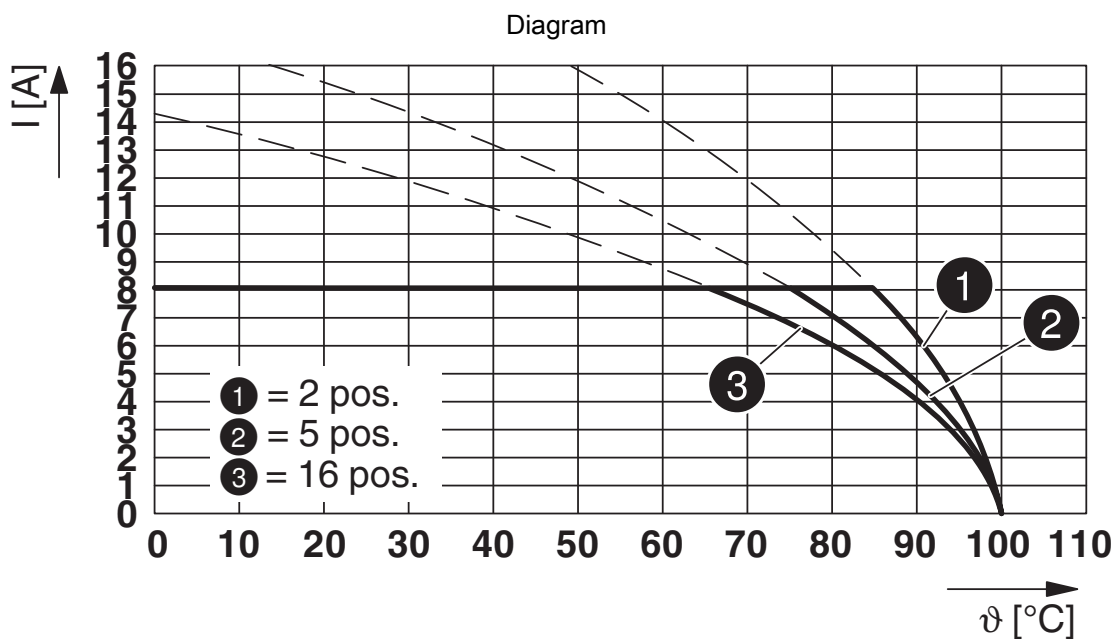

Type: FK-MCP 1,5/...-STF-3,81 with MCDV 1,5/...-G1F-3,81

FK-MCP 1,5/ 3-STF-3,81 - PCB connector



1851245

<https://www.phoenixcontact.com/us/products/1851245>



Type: FK-MCP 1,5/...-STF-3,81 with MC 1,5/...-GF-3,81

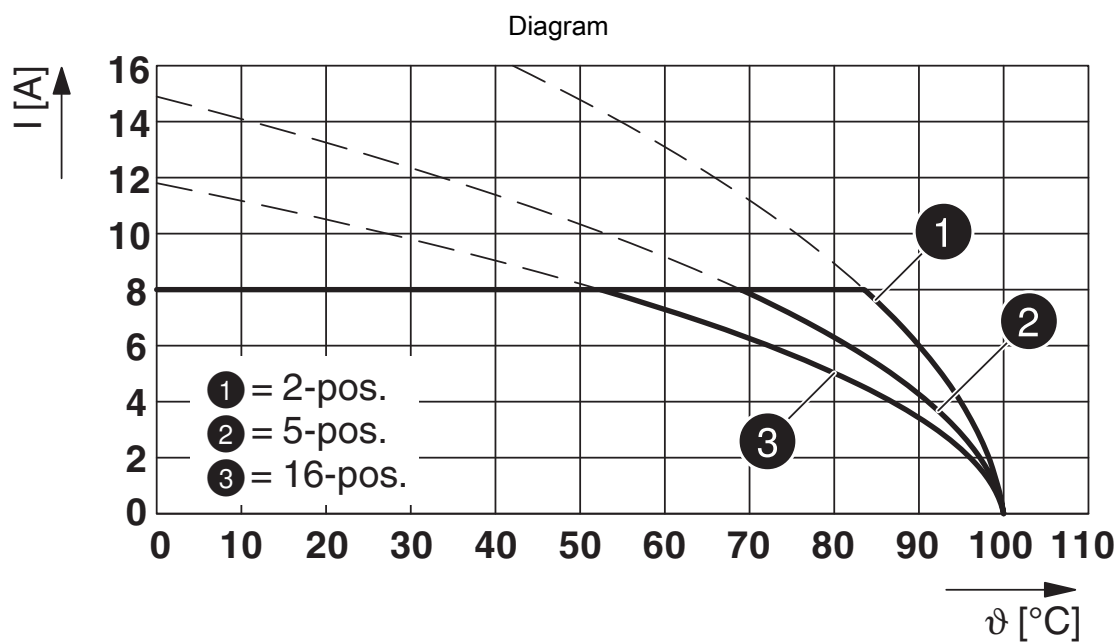

Type: FK-MCP 1,5/...-STF-3,81 with MCD 1,5/...-G1F-3,81

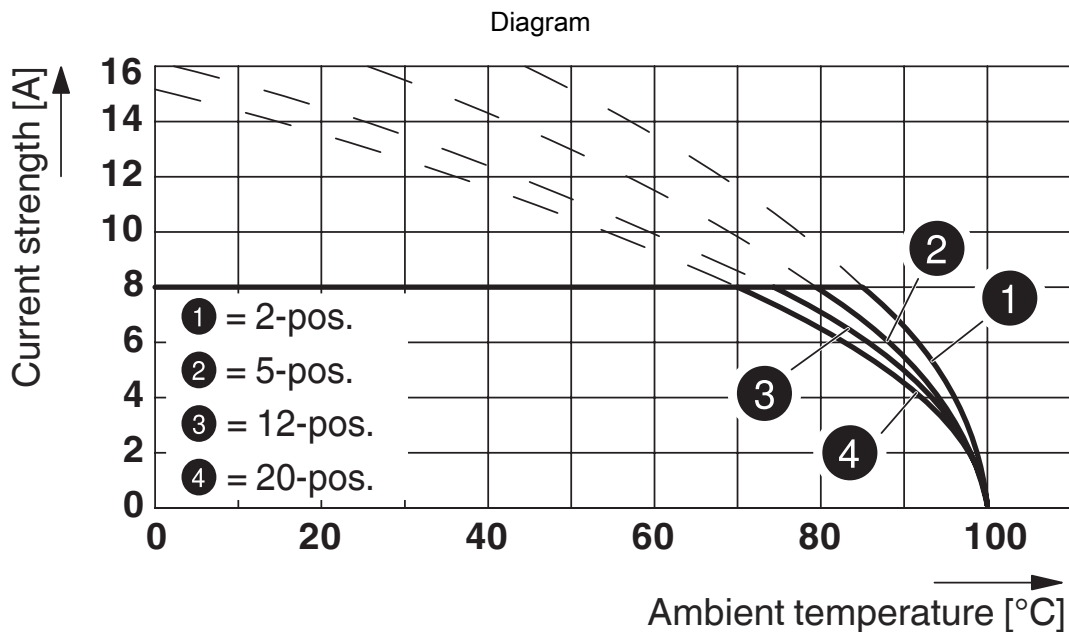

Type: FK-MCP 1,5/...-STF-3,81 with MC 1,5/...-GF-3,81 P... THR

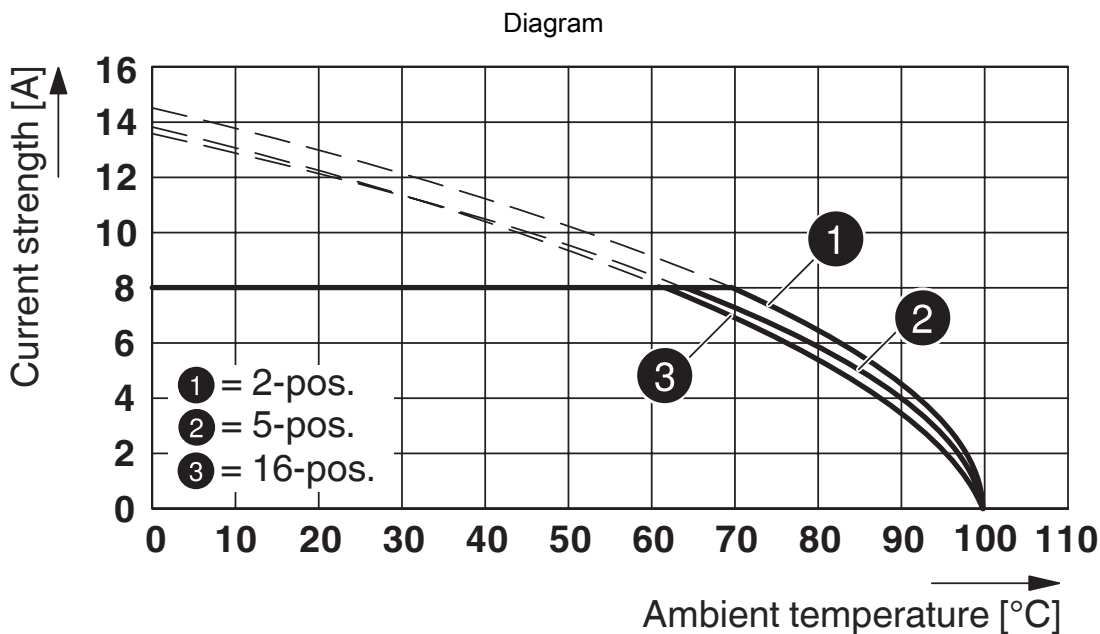

Type: FK-MCP 1,5/...-STF-3,81 with DFK-MC 1,5/...-GF-3,81

FK-MCP 1,5/ 3-STF-3,81 - PCB connector



1851245

<https://www.phoenixcontact.com/us/products/1851245>

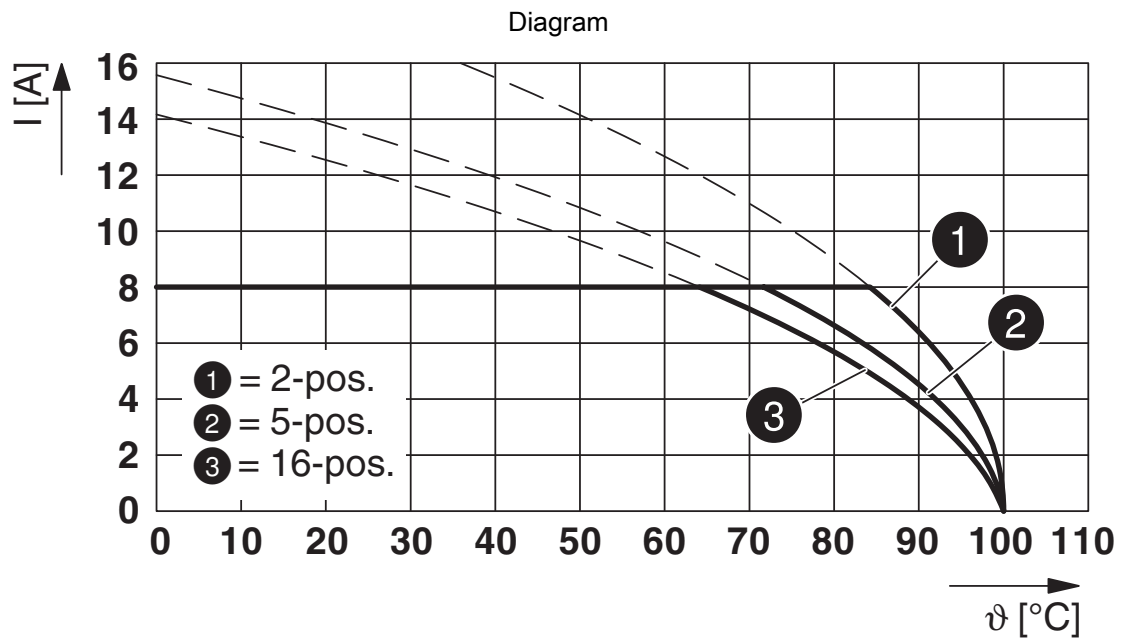

Type: FK-MCP 1,5/...-STF-3,81 with MCDV 1,5/...-GF-3,81

FK-MCP 1,5/ 3-STF-3,81 - PCB connector



1851245

<https://www.phoenixcontact.com/us/products/1851245>

Approvals

 CSA Approval ID: 13631				
	Nominal Voltage U_N	Nominal Current I_N	Cross Section AWG	Cross Section mm^2
Use group B				
	300 V	8 A	28 - 16	-

 IECEE CB Scheme Approval ID: DE1-60987-B1B2				
	Nominal Voltage U_N	Nominal Current I_N	Cross Section AWG	Cross Section mm^2
	160 V	8 A	-	0.2 - 1.5

 EAC Approval ID: B.01687				
--	--	--	--	--

 cULus Recognized Approval ID: E60425-19920306				
	Nominal Voltage U_N	Nominal Current I_N	Cross Section AWG	Cross Section mm^2
Use group B				
	300 V	8 A	28 - 16	-

 VDE Zeichengenehmigung Approval ID: 40011723				
	Nominal Voltage U_N	Nominal Current I_N	Cross Section AWG	Cross Section mm^2
	160 V	8 A	-	-

FK-MCP 1,5/ 3-STF-3,81 - PCB connector



1851245

<https://www.phoenixcontact.com/us/products/1851245>

Classifications

ECLASS

ECLASS-10.0.1	27440309
ECLASS-11.0	27460202
ECLASS-12.0	27460202

ETIM

ETIM 8.0	EC002638
----------	----------

UNSPSC

UNSPSC 21.0	39121400
-------------	----------

FK-MCP 1,5/ 3-STF-3,81 - PCB connector



1851245

<https://www.phoenixcontact.com/us/products/1851245>

Environmental Product Compliance

China RoHS	Environmentally friendly use period: unlimited = EFUP-e
	No hazardous substances above threshold values

FK-MCP 1,5/ 3-STF-3,81 - PCB connector



1851245

<https://www.phoenixcontact.com/us/products/1851245>

Accessories

SZS 0,4X2,5 VDE - Screwdriver

1205037

<https://www.phoenixcontact.com/us/products/1205037>



Screwdriver, slot-headed, VDE insulated, size: 0.4 x 2.5 x 80 mm, 2-component grip, with non-slip grip

SK 3,81/2,8:FORTL.ZAHLEN - Marker card

0804109

<https://www.phoenixcontact.com/us/products/0804109>

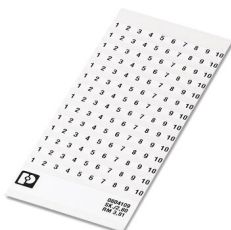

Marker card, white, labeled, horizontal: consecutive numbers 1 ... 10, 11 ... 20, etc. up to 91 ... (99)100, mounting type: adhesive, for terminal block width: 3.81 mm, lettering field size: 3.81 x 2.8 mm

FK-MCP 1,5/ 3-STF-3,81 - PCB connector



1851245

<https://www.phoenixcontact.com/us/products/1851245>

CRIMPFOX 6 - Crimping pliers

1212034

<https://www.phoenixcontact.com/us/products/1212034>



Crimping pliers, for ferrules without insulating collar according to DIN 46228 Part 1 and ferrules with insulating collar according to DIN 46228 Part 4, 0.25 mm² ... 6.0 mm², lateral entry, trapezoidal crimp

MCV 1,5/ 3-GF-3,81 P14 THR - PCB header

1707227

<https://www.phoenixcontact.com/us/products/1707227>

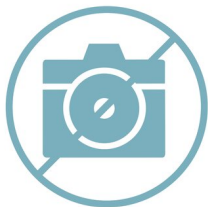

PCB headers, nominal cross section: 1.5 mm², color: black, nominal current: 8 A, rated voltage (III/2): 160 V, contact surface: Tin, type of contact: Pin, number of potentials: 3, number of rows: 1, number of positions: 3, number of connections: 3, product range: MCV 1,5/...-GF-THR, pitch: 3.81 mm, mounting: THR soldering, pin layout: Linear pinning, solder pin [P]: 1.4 mm, number of solder pins per potential: 1, plug-in system: COMBICON MC 1,5, Pin connector pattern alignment: Standard, locking: Screw locking, mounting: Threaded flange, type of packaging: packed in cardboard, For user information and design recommendations for through-hole reflow technology, go to: Downloads

FK-MCP 1,5/ 3-STF-3,81 - PCB connector



1851245

<https://www.phoenixcontact.com/us/products/1851245>

MCV 1,5/ 3-GF-3,81 P26 THR - PCB header

1707641

<https://www.phoenixcontact.com/us/products/1707641>

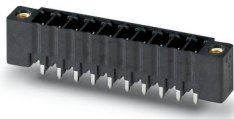

PCB headers, nominal cross section: 1.5 mm², color: black, nominal current: 8 A, rated voltage (III/2): 160 V, contact surface: Tin, type of contact: Pin, number of potentials: 3, number of rows: 1, number of positions: 3, number of connections: 3, product range: MCV 1,5/...-GF-THR, pitch: 3.81 mm, mounting: THR soldering, pin layout: Linear pinning, solder pin [P]: 2.6 mm, number of solder pins per potential: 1, plug-in system: COMBICON MC 1,5, Pin connector pattern alignment: Standard, locking: Screw locking, mounting: Threaded flange, type of packaging: packed in cardboard, For user information and design recommendations for through-hole reflow technology, go to: Downloads

Phoenix Contact 2023 © - all rights reserved

<https://www.phoenixcontact.com>

Phoenix Contact USA
586 Fulling Mill Road
Middletown, PA 17057, United States
(+717) 944-1300
info@phoenixcon.com