

VERTISOCKETS SERIES 800

Collet Contacts

P.O. Box 130, Frenchtown, NJ 08825
Phone 1-908-996-6841
FAX 1-908-996-3891

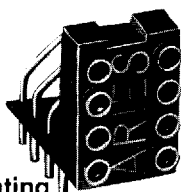

Vertical Mounting

Collet Contacts
.200 (5,08), .300 (7,62), .600 (15,24) Centers
8 thru 16 pins

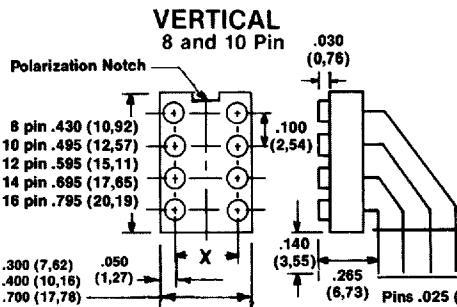
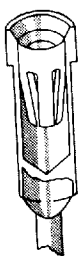

Display on .200 (5,08) Centers X = .200 (5,08) Centers 8-2810-90C 10-2810-90C	Display on .300 (7,62) Centers X = .300 (7,62) Centers 8-810-90C 10-810-90C 12-810-90C 14-810-90C 16-810-90C	Display on .600 (15,24) Centers X = .600 (15,24) Centers 8-6810-90C 10-6810-90C 12-6810-90C 14-6810-90C 16-6810-90C
---	---	--

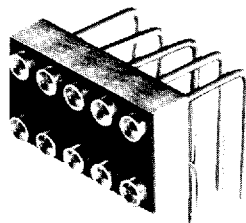

Horizontal Mounting

Collet Contacts
.200 (5,08) Centers
6 to 48 pins



- 6 pin .300 (7,62)
- 8 pin .400 (10,16)
- 10 pin .500 (12,70)
- 12 pin .600 (15,24)
- 14 pin .700 (17,78)
- 16 pin .800 (20,32)
- 18 pin .900 (22,86)
- 20 pin 1.000 (25,40)
- 22 pin 1.100 (27,94)
- 24 pin 1.200 (30,48)
- 26 pin 1.300 (33,02)
- 28 pin 1.400 (35,56)
- 30 pin 1.500 (38,10)
- 32 pin 1.600 (40,64)
- 34 pin 1.700 (43,18)
- 36 pin 1.800 (45,72)
- 38 pin 1.900 (48,26)
- 40 pin 2.000 (50,80)
- 48 pin 2.400 (60,96)

"X" Dim. 90° Non Standard Below Line	Display on .200 (5,08) Centers 90° 6-8280-90C 8-8280-90C 10-2820-90C 12-2820-90C 14-2820-90C 16-2820-90C 18-2820-90C 20-2820-90C 22-2820-90C 24-2820-90C 26-2820-90C 28-2820-90C 30-2820-90C 32-2820-90C 34-2820-90C 36-2820-90C 38-2820-90C 40-2820-90C 48-2820-90C	Display on .300 (7,62) Centers 90° 6-820-90C 8-820-90C 10-820-90C 12-820-90C 14-820-90C 16-820-90C 18-820-90C 20-820-90C 22-820-90C 24-820-90C 26-820-90C 28-820-90C 30-820-90C 32-820-90C 34-820-90C 36-820-90C 38-820-90C 40-820-90C 48-820-90C	Display on .600 (15,24) Centers 90° 6-6820-90C 8-6820-90C 10-6820-90C 12-6820-90C 14-6820-90C 16-6820-90C 18-6820-90C 20-6820-90C 22-6820-90C 24-6820-90C 26-6820-90C 28-6820-90C 30-6820-90C 32-6820-90C 34-6820-90C 36-6820-90C 38-6820-90C 40-6820-90C 48-6820-90C
--	--	---	---

To Order 30°, 45°, 60° Angle: Substitute 30, 45, or 60 in place of 90 in Catalog No.

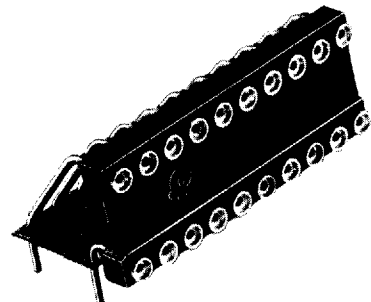

Horizontal Mounting

Collet Contacts
.300 (7,62) Centers
6 to 48 pins

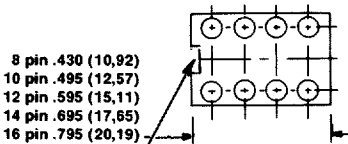

Polarization Notch: Pin 1 Identification for .200 Vertisockets

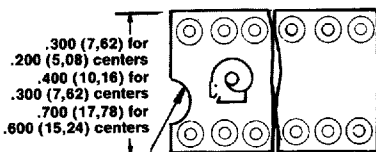

Polarization Notch: Pin 1 Identification for .300 and .600 Vertisockets

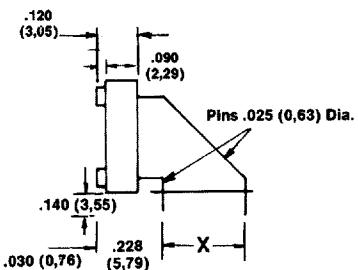

"X" Dim. 90° Non Standard Below Line	Display on .200 (5,08) Centers 90° 6-2822-90C 8-2822-90C 10-2822-90C 12-2822-90C 14-2822-90C 16-2822-90C 18-2822-90C 20-2822-90C 22-2822-90C 24-2822-90C 26-2822-90C 28-2822-90C 30-2822-90C 32-2822-90C 34-2822-90C 36-2822-90C 38-2822-90C 40-2822-90C 48-2822-90C	Display on .300 (7,62) Centers 90° 6-822-90C 8-822-90C 10-822-90C 12-822-90C 14-822-90C 16-822-90C 18-822-90C 20-822-90C 22-822-90C 24-822-90C 26-822-90C 28-822-90C 30-822-90C 32-822-90C 34-822-90C 36-822-90C 38-822-90C 40-822-90C 48-822-90C	Display on .600 (15,24) Centers 90° 6-6822-90C 8-6822-90C 10-6822-90C 12-6822-90C 14-6822-90C 16-6822-90C 18-6822-90C 20-6822-90C 22-6822-90C 24-6822-90C 26-6822-90C 28-6822-90C 30-6822-90C 32-6822-90C 34-6822-90C 36-6822-90C 38-6822-90C 40-6822-90C 48-6822-90C
--	--	---	---

To Order 30°, 45°, 60° Angle: Substitute 30, 45, or 60 in place of 90 in Catalog No.

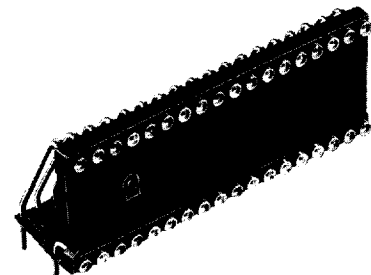

Horizontal Mounting

Collet Contacts
.600 (15,24) Centers
6 to 48 pins

SPECIFICATIONS

- Collet accepts: .015 (0,38) - .022 (0,55) dia. round leads
- Contacts: Collet—Beryllium copper
Body—Brass
- Plating: Collet: 30µ (0,76µm) gold per MIL-G-45204 over 50µ (1,27µm) nickel per QQN-290. Thicker gold plating available (consult factory).
Body: Tin plated
- Material: Glass filled thermoplastic

"X" Dim. 90° Non Standard Below Line	Display on .200 (5,08) Centers 90° 6-8223-90C 8-8223-90C 10-2823-90C 12-2823-90C 14-2823-90C 16-2823-90C 18-2823-90C 20-2823-90C 22-2823-90C 24-2823-90C 26-2823-90C 28-2823-90C 30-2823-90C 32-2823-90C 34-2823-90C 36-2823-90C 38-2823-90C 40-2823-90C 48-2823-90C	Display on .300 (7,62) Centers 90° 6-823-90C 8-823-90C 10-823-90C 12-823-90C 14-823-90C 16-823-90C 18-823-90C 20-823-90C 22-823-90C 24-823-90C 26-823-90C 28-823-90C 30-823-90C 32-823-90C 34-823-90C 36-823-90C 38-823-90C 40-823-90C 48-823-90C	Display on .600 (15,24) Centers 90° 6-6823-90C 8-6823-90C 10-6823-90C 12-6823-90C 14-6823-90C 16-6823-90C 18-6823-90C 20-6823-90C 22-6823-90C 24-6823-90C 26-6823-90C 28-6823-90C 30-6823-90C 32-6823-90C 34-6823-90C 36-6823-90C 38-6823-90C 40-6823-90C 48-6823-90C
--	--	---	---

To Order 30°, 45°, 60° Angle: Substitute 30, 45, or 60 in place of 90 in Catalog No.