



**Whisper XL AC - WX3H1 - 028860**  
 (Family) (Model) (Part Number)

**Electrical Specifications**

Rated Voltage:	230 VAC
AC Frequency:	60 Hz
Power Supply:	13.5 Watts
Line Current:	0.09 Amps
Locked Rotor Current	0.10 Amps
Nominal Speed:	2525 RPM



**Mechanical Specifications**

Dimensions:	4.72in x 1.50in
Weight	21.0 oz
Max Airflow @ 0 in H <sub>2</sub> O	85.0 CFM
Max Pressure @ 0 CFM	0.174 in H <sub>2</sub> O
Noise	37.1 dBA



**Fan Performance**

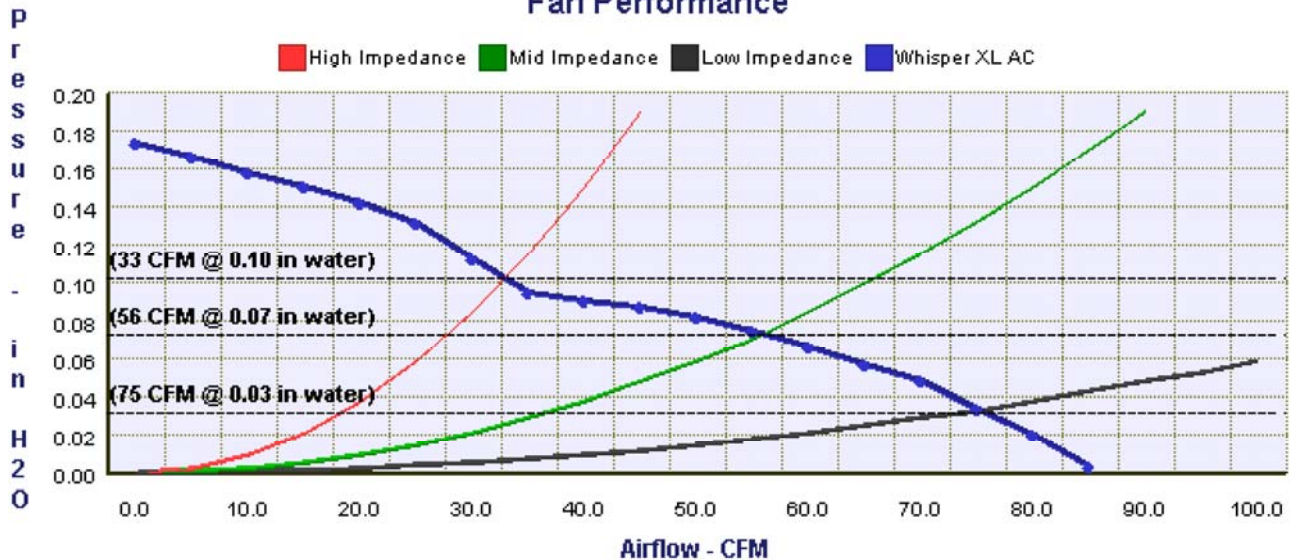

Comair Rotron, Inc.  
 Phone: 858.348.6200  
 sales@comairrotron.com

Comair Rotron Europe, Ltd.  
 Phone: +44.1527.520525  
 saleseurope@comairrotron.com

Comair Rotron Fan Company Ltd.  
 Phone: +86.21.52260581  
 salesasia@comairrotron.com



## Mechanical Drawing

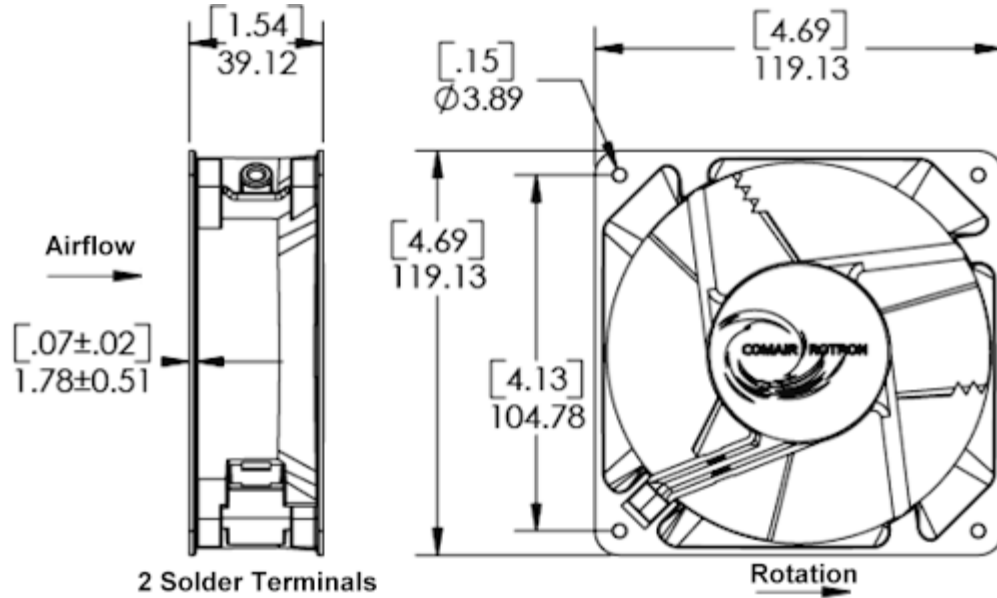

## Options

Part Number	Model Number	Bearing Type	Fan Rotation	Termination	In-Stock <small>(Click 'Yes' for current stock)</small>
☉ 028860	WX3H1	Sleeve	Reverse	0.120 Terminals, Venturi	<a href="#">Yes</a>

## Accessories (Click on part number for detailed drawing.)

428056  
Plug and Cord

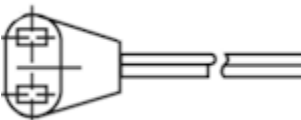

550440  
Plug and Cord

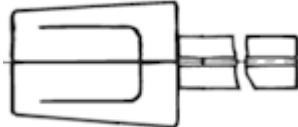

550113  
Mounting Clip



551590  
Filter Assembly

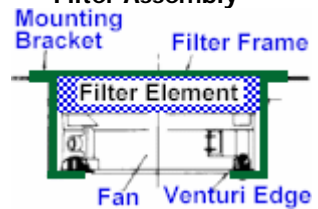

554148  
Filter Guard Assembly

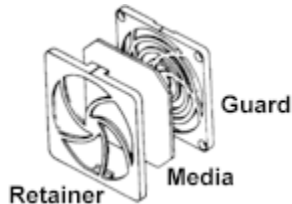

552934  
Finger Guard

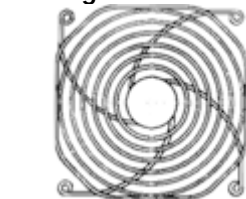

476042  
Finger Guard

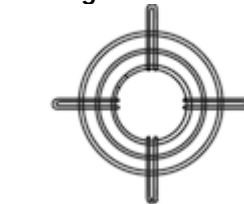

550481  
Finger Guard

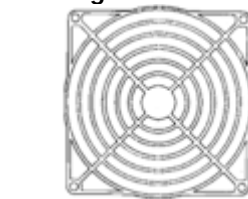

551147  
Finger Guard



**Comair Rotron, Inc.**  
Phone: 858.348.6200  
sales@comairrotron.com

**Comair Rotron Europe, Ltd.**  
Phone: +44.1527.520525  
saleseurope@comairrotron.com

**Comair Rotron Fan Company Ltd.**  
Phone: +86.21.52260581  
salesasia@comairrotron.com

Print Date: Thursday, November 22, 2007 at 01:07:32 - AC Fan Datasheet - Web Version 1.0 Rev. A