

TERMINAL Standard consumption

THICKNESS 0.50 mm

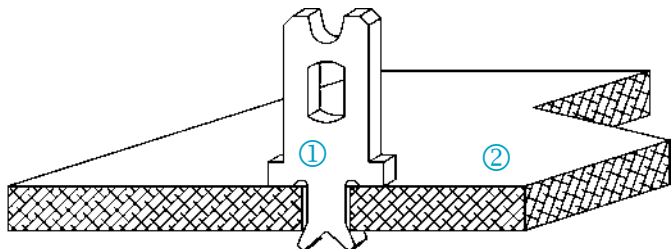

- ① - TERMINALS TO BE INSERTED
- ② - PCB

E01295

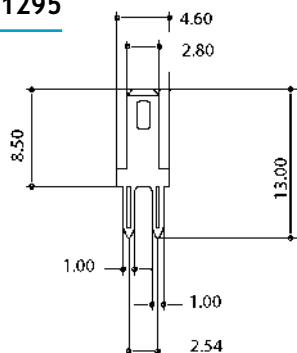

Ø PCB hole : 1.00 mm* - Thickness : 0.50 mm

E01845

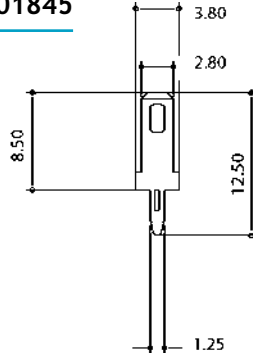

Ø PCB hole : 1.20 mm* - Thickness : 0.50 mm

E04225

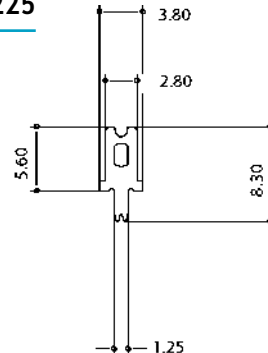

Ø PCB hole : 1.25 mm* - Thickness : 0.50 mm

E04475

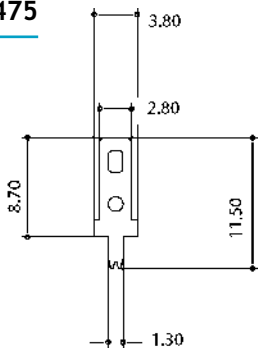

Ø PCB hole : 1.30 mm* - Thickness : 0.50 mm

E05705

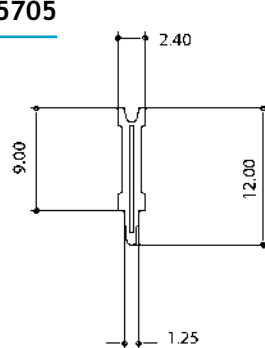

Ø PCB hole : 1.20 mm* - Thickness : 0.50 mm

E05715

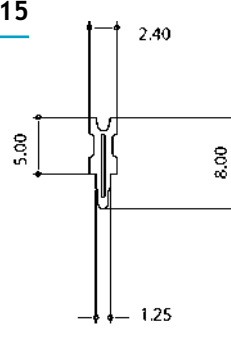

Ø PCB hole : 1.20 mm* - Thickness : 0.50 mm

E10215

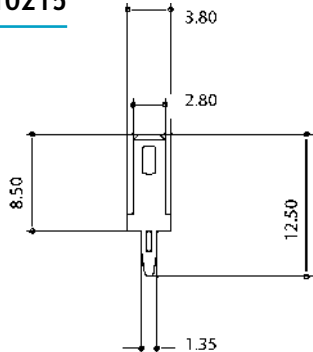

Ø PCB hole : 1.30 mm* - Thickness : 0.50 mm

E11305

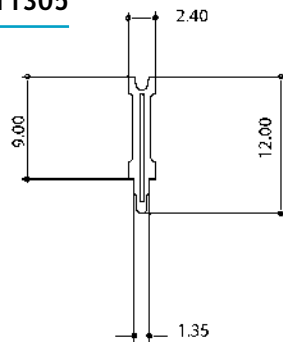

Ø PCB hole : 1.30 mm* - Thickness : 0.50 mm

E11315

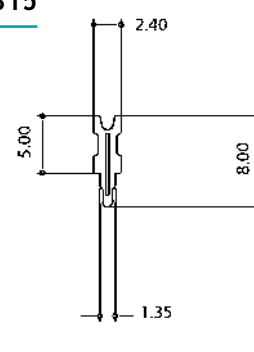

Ø PCB hole : 1.30 mm* - Thickness : 0.50 mm

* JUST AS INDICATION (DEPENDS ON PCB THICKNESS AND MATERIAL)



TERMINAL Standard consumption

THICKNESSES 0.60 mm- 0.80 mm

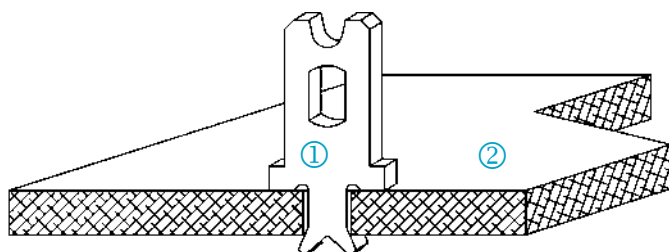

- ① - TERMINALS TO BE INSERTED
- ② - PCB

E02066

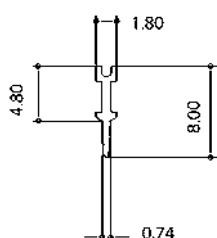

∅ PCB hole : 0.80 mm* - Thickness : 0.60 mm

E03096

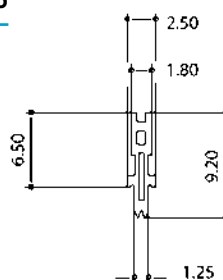

∅ PCB hole : 1.30 mm* - Thickness : 0.60 mm

E03966

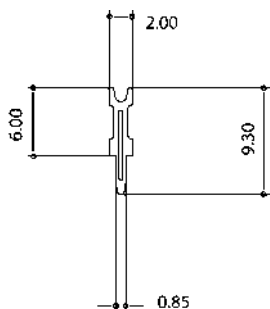

∅ PCB hole : 0.90 mm* - Thickness : 0.60 mm

E04816

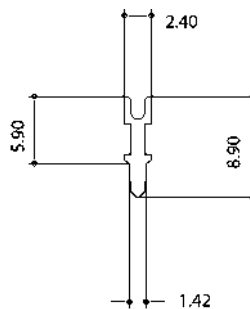

∅ PCB hole : 1.40 mm* - Thickness : 0.60 mm

E06896

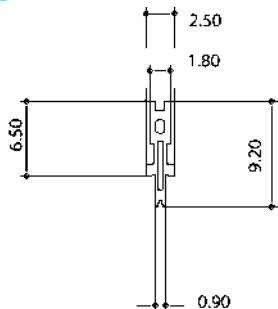

∅ PCB hole : 1.00 mm* - Thickness : 0.60 mm

E03408

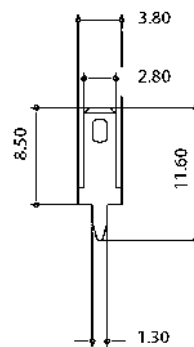

∅ PCB hole : 1.30 mm* - Thickness : 0.80 mm



TERMINAL Standard consumption

THICKNESSES 0.50 mm - 0.80 mm

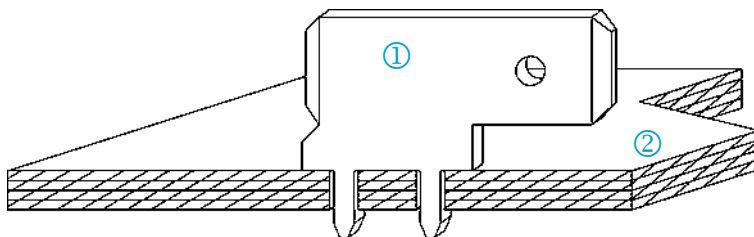

- ① - TERMINALS TO BE INSERTED
- ② - PCB

E01955

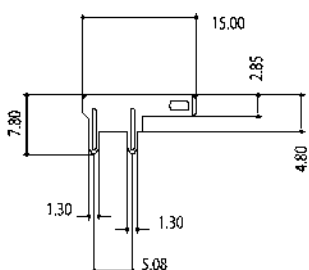

∅ PCB hole : 1.20 mm* - Thickness : 0.50 mm

E03228

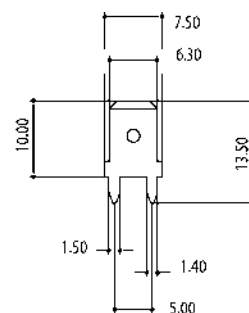

∅ PCB hole : 1.50 mm* - Thickness : 0.80 mm

E04828

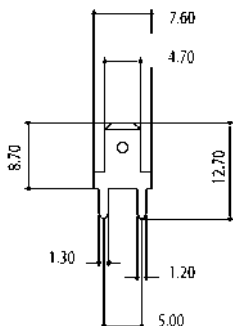

∅ PCB hole : 1.40 mm* - Thickness : 0.80 mm

E05088

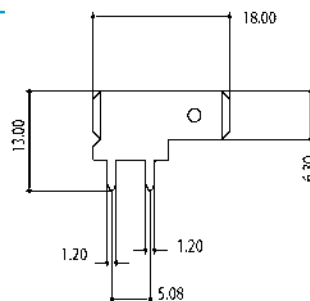

∅ PCB hole : 1.30 mm* - Thickness : 0.80 mm

E09438

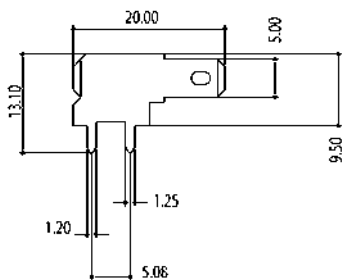

∅ PCB hole : 1.30 mm* - Thickness : 0.80 mm

E27188

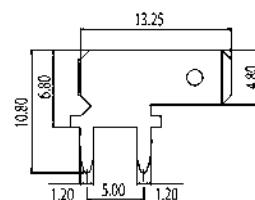

∅ PCB hole : 1.30 mm* - Thickness : 0.80 mm

