

Data sheet | Item number: 859-730

Optocoupler module; Nominal input voltage: 24 VDC; Output voltage range: 3 ... 30 VDC; Limiting continuous current: 3 A; 2-wire connection; Module width: 6 mm; gray

www.wago.com/859-730

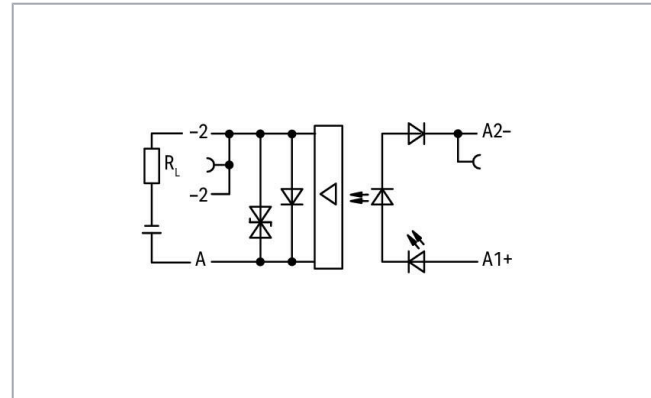
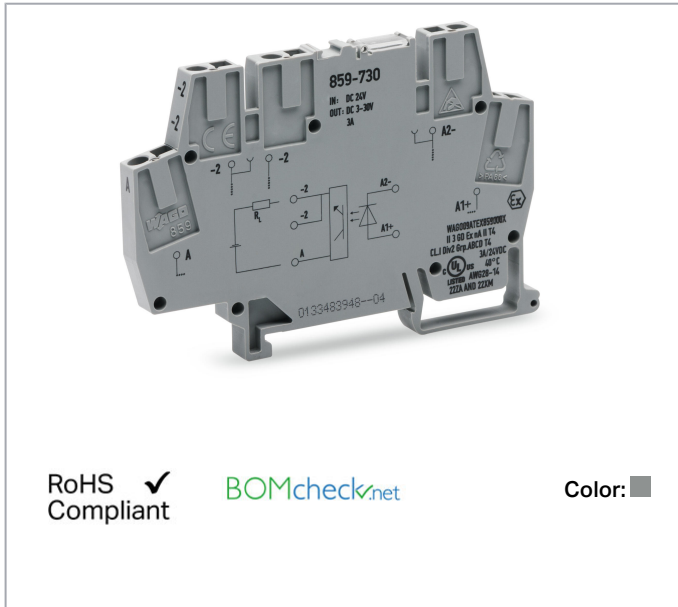

RoHS Compliant

[BOMcheck.net](https://www.bomcheck.net)

Color:

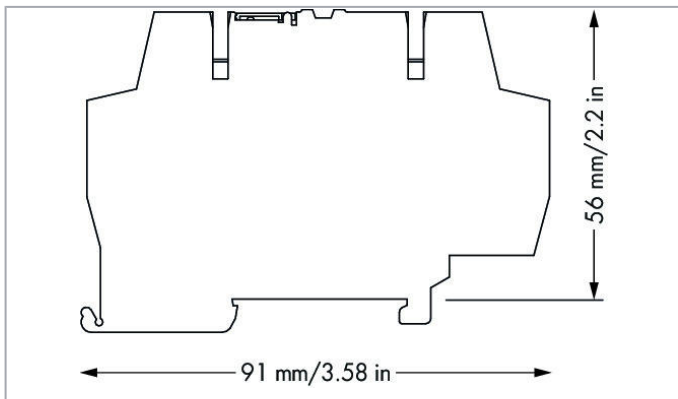

Item description

Note:

Optocouplers and solid state relays are designed for use in signal processing networks, which are not supplied by the low-voltage power supply networks.

Data

Technical data

Subject to changes. Please also observe the further product documentation!

WAGO Kontakttechnik GmbH & Co. KG
Hansastr. 27
32423 Minden
Phone: +49571 887-0 | Fax: +49571 887-169
Email: info.de@wago.com | Web: www.wago.com

Do you have any questions about our products?
We are always happy to take your call at +49 (571) 887-44222.

Control circuit

Nominal input voltage U_N	DC 24 V
Input voltage range (low level)	DC 0 ... 5 V
Input voltage range (high level)	DC 15 ... 27 V
Nominal input current at U_N	14 mA

Load circuit

Circuit type	2-wire connection
Limiting continuous current	3 A
Peak output current	25 A
Nominal output voltage	DC 24 V
Output voltage range	DC 3 ... 30 V
Voltage drop at output (max.)	≤ DC 0.2 V
Turn-on time	≤ 25 μs
Turn-off time	≤ 450 μs
Switching frequency	≤ 350 Hz

Signaling

Status indicator	Red LED
------------------	---------

Safety and protection

Rated voltage	300 V
Overvoltage category	II
Pollution degree	2
Dielectric strength, control/load circuit (AC, 1 min)	2.5 kVrms
Insulation type (control/load circuit)	Basic insulation
Insulation type (adjacent devices)	Reinforced insulation (safe isolation)

Connection data

Connection technology	CAGE CLAMP®
Solid conductor	0.08 ... 2.5 mm ² / 28 ... 14 AWG
Fine-stranded conductor	0.08 ... 2.5 mm ² / 28 ... 14 AWG
Strip length	5 ... 6 mm / 0.2 ... 0.24 inch

Subject to changes. Please also observe the further product documentation!



Physical data

Width	6 mm / 0.236 inch
Height from upper-edge of DIN-rail	56 mm / 2.205 inch
Depth	91 mm / 3.583 inch

Mechanical data

Mounting type	DIN-35 rail
---------------	-------------

Material data

Color	gray
Fire load	0.313 MJ
Weight	18.5 g

Environmental requirements

Surrounding air temperature (operation at U_N)	-25 ... 55 °C
Surrounding air temperature (storage)	-40 ... 70 °C
Processing temperature	-25 ... +50 °C
Relative humidity	5 ... 95 % (no condensation permissible)
Operating altitude (max.)	2000 m

Standards and specifications

Standards/Specifications	EN 61010-2-201; EN 61000-6-2; EN 61000-6-3; EN 61373; UL 508
--------------------------	--

Commercial data

Product Group	6 (Interface Electronics)
Packaging type	BOX
Country of origin	CN
GTIN	4055143604987
Customs tariff number	85365005000

Approvals / Certificates

Ex-Approvals

Logo	Approval	Additional Approval Text	Certificate name
	CCCEX CQST/CNEx	CNCA-C23-01	2021312304000982

Subject to changes. Please also observe the further product documentation!



Ex nA IIC T4 Gc













UL
UL International Germany GmbH (HAZARDOUS
LOCATIONS)

UL 508

E198726 Sec.3

Compatible products

Jumper

	Item no.: 859-402 Jumper; for jumper slot; 2-way; insulated; light gray	www.wago.com/859-402
	Item no.: 859-402/000-005 Jumper; for jumper slot; 2-way; insulated; red	www.wago.com/859-402/000-005
	Item no.: 859-402/000-006 Jumper; for jumper slot; 2-way; insulated; blue	www.wago.com/859-402/000-006
	Item no.: 859-402/000-029 Jumper; for jumper slot; 2-way; insulated; yellow	www.wago.com/859-402/000-029
	Item no.: 859-403 Jumper; for jumper slot; 3-way; insulated; light gray	www.wago.com/859-403
	Item no.: 859-403/000-005 Jumper; for jumper slot; 3-way; insulated; red	www.wago.com/859-403/000-005
	Item no.: 859-403/000-006 Jumper; for jumper slot; 3-way; insulated; blue	www.wago.com/859-403/000-006
	Item no.: 859-403/000-029 Jumper; for jumper slot; 3-way; insulated; yellow	www.wago.com/859-403/000-029
	Item no.: 859-404 Jumper; for jumper slot; 4-way; insulated; light gray	www.wago.com/859-404
	Item no.: 859-404/000-005 Jumper; for jumper slot; 4-way; insulated; red	www.wago.com/859-404/000-005

Subject to changes. Please also observe the further product documentation!



Item no.: 859-404/000-006
Jumper; for jumper slot; 4-way; insulated; blue

www.wago.com/859-404/000-006



Item no.: 859-404/000-029
Jumper; for jumper slot; 4-way; insulated; yellow

www.wago.com/859-404/000-029



Item no.: 859-405
Jumper; for jumper slot; 5-way; insulated; light gray

www.wago.com/859-405



Item no.: 859-405/000-005
Jumper; for jumper slot; 5-way; insulated; red

www.wago.com/859-405/000-005



Item no.: 859-405/000-006
Jumper; for jumper slot; 5-way; insulated; blue

www.wago.com/859-405/000-006



Item no.: 859-405/000-029
Jumper; for jumper slot; 5-way; insulated; yellow

www.wago.com/859-405/000-029



Item no.: 859-406
Jumper; for jumper slot; 6-way; insulated; light gray

www.wago.com/859-406



Item no.: 859-406/000-005
Jumper; for jumper slot; 6-way; insulated; red

www.wago.com/859-406/000-005



Item no.: 859-406/000-006
Jumper; for jumper slot; 6-way; insulated; blue

www.wago.com/859-406/000-006



Item no.: 859-406/000-029
Jumper; for jumper slot; 6-way; insulated; signal yellow

www.wago.com/859-406/000-029



Item no.: 859-407
Jumper; for jumper slot; 7-way; insulated; light gray

www.wago.com/859-407



Item no.: 859-407/000-005
Jumper; for jumper slot; 7-way; insulated; red

www.wago.com/859-407/000-005



Item no.: 859-407/000-006
Jumper; for jumper slot; 7-way; insulated; blue















www.wago.com/859-407/000-006

















Item no.: 859-407/000-029
Jumper; for jumper slot; 7-way; insulated; yellow

www.wago.com/859-407/000-029

Subject to changes. Please also observe the further product documentation!

	Item no.: 859-408 Jumper; for jumper slot; 8-way; insulated; light gray	www.wago.com/859-408
	Item no.: 859-408/000-005 Jumper; for jumper slot; 8-way; insulated; red	www.wago.com/859-408/000-005
	Item no.: 859-408/000-006 Jumper; for jumper slot; 8-way; insulated; blue	www.wago.com/859-408/000-006
	Item no.: 859-408/000-029 Jumper; for jumper slot; 8-way; insulated; yellow	www.wago.com/859-408/000-029
	Item no.: 859-409 Jumper; for jumper slot; 9-way; insulated; light gray	www.wago.com/859-409
	Item no.: 859-409/000-005 Jumper; for jumper slot; 9-way; insulated; red	www.wago.com/859-409/000-005
	Item no.: 859-409/000-006 Jumper; for jumper slot; 9-way; insulated; blue	www.wago.com/859-409/000-006
	Item no.: 859-409/000-029 Jumper; for jumper slot; 9-way; insulated; yellow	www.wago.com/859-409/000-029
	Item no.: 859-410 Jumper; for jumper slot; 10-way; insulated; light gray	www.wago.com/859-410
	Item no.: 859-410/000-005 Jumper; for jumper slot; 10-way; insulated; red	www.wago.com/859-410/000-005
	Item no.: 859-410/000-006 Jumper; for jumper slot; 10-way; insulated; blue	www.wago.com/859-410/000-006
	Item no.: 859-410/000-029 Jumper; for jumper slot; 10-way; insulated; yellow	www.wago.com/859-410/000-029
tools		
	Item no.: 210-720 Operating tool; Blade: 3.5 x 0.5 mm; with a partially insulated shaft; multicoloured	www.wago.com/210-720
Marking accessories		
	Item no.: 2009-145 Mini-WSB Inline; for Smart Printer; 1700 pieces on roll; stretchable 5 - 5.2 mm; plain; snap-on type; white	www.wago.com/2009-145

Subject to changes. Please also observe the further product documentation!

	Item no.: 2009-145/000-002 Mini-WSB Inline; for Smart Printer; 1700 pieces on roll; stretchable 5 - 5.2 mm; plain; snap-on type; yellow	www.wago.com/2009-145/000-002
	Item no.: 2009-145/000-005 Mini-WSB Inline; for Smart Printer; 1700 pieces on roll; stretchable 5 - 5.2 mm; plain; snap-on type; red	www.wago.com/2009-145/000-005
	Item no.: 2009-145/000-006 Mini-WSB Inline; for Smart Printer; 1700 pieces on roll; stretchable 5 - 5.2 mm; plain; snap-on type; blue	www.wago.com/2009-145/000-006
	Item no.: 2009-145/000-007 Mini-WSB Inline; for Smart Printer; 1700 pieces on roll; stretchable 5 - 5.2 mm; plain; snap-on type; gray	www.wago.com/2009-145/000-007
	Item no.: 2009-145/000-012 Mini-WSB Inline; for Smart Printer; 1700 pieces on roll; stretchable 5 - 5.2 mm; plain; snap-on type; orange	www.wago.com/2009-145/000-012
	Item no.: 2009-145/000-023 Mini-WSB Inline; for Smart Printer; 1700 pieces on roll; stretchable 5 - 5.2 mm; plain; snap-on type; green	www.wago.com/2009-145/000-023
	Item no.: 2009-145/000-024 Mini-WSB Inline; for Smart Printer; 1700 pieces on roll; stretchable 5 - 5.2 mm; plain; snap-on type; violet	www.wago.com/2009-145/000-024
	Item no.: 210-110 Fiber-tip pen	www.wago.com/210-110
	Item no.: 248-501 Miniature WSB Quick marking system; plain; Marker width 5 mm; 10 strips with 10 markers per card	www.wago.com/248-501
	Item no.: 248-501/000-002 Mini-WSB marking card; as card; not stretchable; plain; snap-on type; yellow	www.wago.com/248-501/000-002
	Item no.: 248-501/000-005 Mini-WSB marking card; as card; not stretchable; plain; snap-on type; red	www.wago.com/248-501/000-005
	Item no.: 248-501/000-006 Mini-WSB marking card; as card; not stretchable; plain; snap-on type; blue	www.wago.com/248-501/000-006
	Item no.: 248-501/000-007 Mini-WSB marking card; as card; not stretchable; plain; snap-on type; gray	www.wago.com/248-501/000-007
	Item no.: 248-501/000-012 Mini-WSB marking card; as card; not stretchable; plain; snap-on type; orange	www.wago.com/248-501/000-012

Subject to changes. Please also observe the further product documentation!

**Item no.: 248-501/000-017**

Mini-WSB marking card; as card; not stretchable; plain; snap-on type; light green

www.wago.com/248-501/000-017**Item no.: 248-501/000-023**

Mini-WSB marking card; as card; not stretchable; plain; snap-on type; green

www.wago.com/248-501/000-023**Item no.: 248-501/000-024**

Mini-WSB marking card; as card; not stretchable; plain; snap-on type; violet

www.wago.com/248-501/000-024**Item no.: 248-502**

Mini-WSB marking card; as card; MARKED; 1 ... 10 (10x); not stretchable; Horizontal marking; snap-on type; white

www.wago.com/248-502**Item no.: 248-502/000-024**

Mini-WSB marking card; as card; MARKED; 1 ... 10 (10x); not stretchable; Horizontal marking; snap-on type; violet

www.wago.com/248-502/000-024**Item no.: 248-503**

Mini-WSB marking card; as card; MARKED; 11 ... 20 (10x); not stretchable; Horizontal marking; snap-on type; white

www.wago.com/248-503**Item no.: 248-503/000-024**

Mini-WSB marking card; as card; MARKED; 11 ... 20 (10x); not stretchable; Horizontal marking; snap-on type; violet

www.wago.com/248-503/000-024**Item no.: 248-504**

Mini-WSB marking card; as card; MARKED; 21 ... 30 (10x); not stretchable; Horizontal marking; snap-on type; white

www.wago.com/248-504**Item no.: 248-504/000-024**

Mini-WSB marking card; as card; MARKED; 21 ... 30 (10x); not stretchable; Horizontal marking; snap-on type; violet

www.wago.com/248-504/000-024**Item no.: 248-505/000-024**

Mini-WSB marking card; as card; MARKED; 31 ... 40 (10x); not stretchable; Horizontal marking; snap-on type; violet

www.wago.com/248-505/000-024**Item no.: 248-506**

Mini-WSB marking card; as card; MARKED; 41 ... 50 (10x); not stretchable; Horizontal marking; snap-on type; white

www.wago.com/248-506**ferrule****Item no.: 216-221**Ferrule; Sleeve for 0.5 mm² / 20 AWG; insulated; electro-tin plated; whitewww.wago.com/216-221**Item no.: 216-222**Ferrule; Sleeve for 0.75 mm² / 18 AWG; insulated; electro-tin plated; graywww.wago.com/216-222**Item no.: 216-223**Ferrule; Sleeve for 1 mm² / AWG 18; insulated; electro-tin plated; redwww.wago.com/216-223**Item no.: 216-224**Ferrule; Sleeve for 1.5 mm² / AWG 16; insulated; electro-tin plated; blackwww.wago.com/216-224

Subject to changes. Please also observe the further product documentation!

WAGO Kontakttechnik GmbH & Co. KG

Hansastr. 27

32423 Minden

Phone: +49571 887-0 | Fax: +49571 887-169

Email: info.de@wago.com | Web: www.wago.com

Do you have any questions about our products?

We are always happy to take your call at +49 (571) 887-44222.

Item no.: 216-321

Ferrule; Sleeve for 0.25 mm² / AWG 24; insulated; electro-tin plated; yellow

www.wago.com/216-321



Item no.: 216-322

Ferrule; Sleeve for 0.34 mm² / 22 AWG; insulated; electro-tin plated; green

www.wago.com/216-322

check



Item no.: 859-500

Test pin; 1 mm Ø; with solder connection for test wire

www.wago.com/859-500

End plate



Item no.: 859-525

End and intermediate plate; 1 mm thick; gray

www.wago.com/859-525

Downloads

Documentation

Bid Text

859-730 docx - Datei	2019 Feb 20	docx 15.7 kB	Download
859-730 X81 - Datei	2019 Feb 19	xml 3.9 kB	Download

Instruction Leaflet

Relay modules, Optocoupler modules	V 1.2.0 2019 Aug 30	pdf 2.2 MB	Download
------------------------------------	------------------------	---------------	----------

Additional Information

Disposal; Electrical and electronic equipment, Packaging	V 1.0.0	pdf 265.8 kB	Download
--	---------	-----------------	----------

CAD/CAE-Data

CAE data

WSCAD Universe 859-730	URL	Download
ZUKEN Portal 859-730	URL	Download
EPLAN Data Portal 859-730	URL	Download

CAD data

Subject to changes. Please also observe the further product documentation!

2D/3D Models 859-730

[URL](#)

[Download](#)

Environmental Product Compliance

Compliance Search

Environmental Product Compliance 859-730

[URL](#)

[Download](#)

Optocoupler module; Nominal input voltage: 24 VDC; Output voltage range: 3 ... 30 VDC; Limiting continuous current: 3 A; 2-wire connection; Module width: 6 mm; gray

Installation Notes

Conductor termination

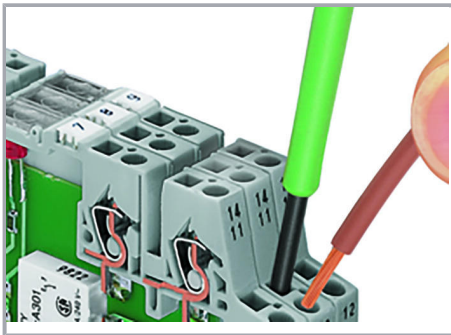

Connection of conductor

Commoning

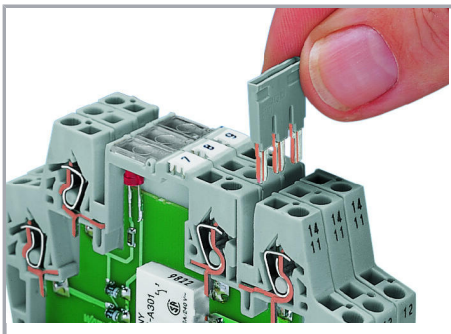

Easy commoning using adjacent jumpers

Marking

Subject to changes. Please also observe the further product documentation!



Marking using miniature WSB quick marking card

Subject to changes. Please also observe the further product documentation!