

# Connectors

## SSMA Panel Mount Receptacles Solder Pot Terminal Type

### Straight Flange Mount Female Jack Receptacle - 4 Hole

**Model Number**  
**SSM-5540-15-POT-02**

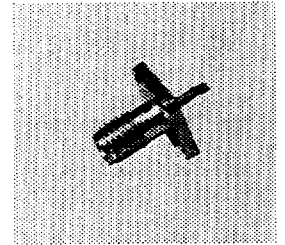
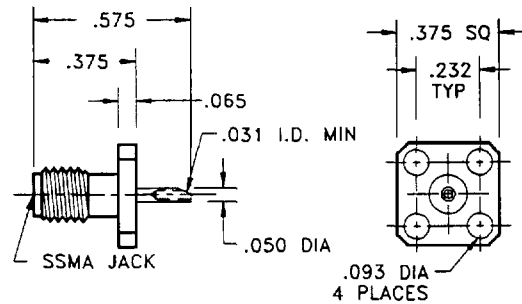

Note: Standard finish is passivated stainless steel, for gold plating change -02 suffix to -00.

### Straight Flange Mount Female Jack Receptacle - 2 Hole

**Model Number**  
**SSM-5240-15-POT-02**

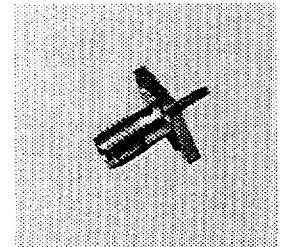
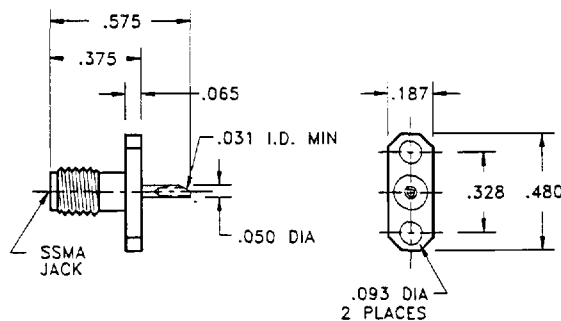

Note: Standard finish is passivated stainless steel, for gold plating change -02 suffix to -00.

### Straight Bulkhead Feedthru Female Jack Receptacle - Rear Mount

**Model Number**  
**SSM-5040-11-POT-02**

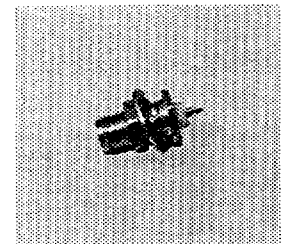
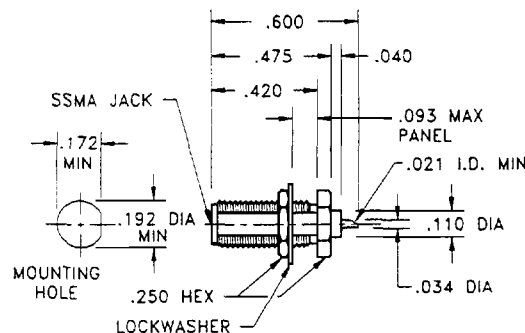

Note: Standard finish is passivated stainless steel, for gold plating change -02 suffix to -00.

### Right Angle Flange Mount Female Jack Receptacle

**Model Number**  
**SSM-5540-16-POT-02**

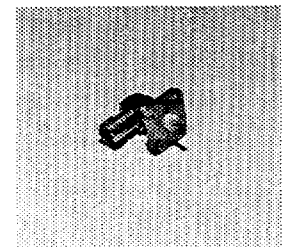
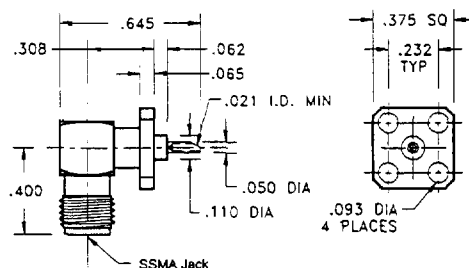

Note: Standard finish is passivated stainless steel, for gold plated coupling nut change -02 suffix to -00.  
Detail interface dimension information can be found in the appendix.