

TRANSISTOR (PNP)

### FEATURES

- NPN Complements to BCX54,BCX55,BCX56
- Low Voltage

### APPLICATIONS

- Medium Power General Purposes
- Driver Stages of Audio Amplifiers

**MARKING:BCX51:AA, BCX51-10:AC, BCX51-16:AD  
BCX52:AE, BCX52-10:AG, BCX52-16:AM  
BCX53:A H, BCX53-10:AK, BCX53-16:AL**

### SOT-89-3L

1. BASE
2. COLLECTOR
3. EMITTER

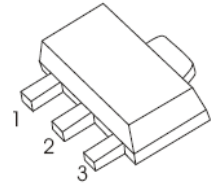

### MAXIMUM RATINGS (T<sub>a</sub>=25°C unless otherwise noted)

Symbol	Parameter	Value	Unit
<b>V<sub>CBO</sub></b>	Collector-Base Voltage	BCX51	-45
		BCX52	-60
		BCX53	-100
<b>V<sub>CEO</sub></b>	Collector-Emitter Voltage	BCX51	-45
		BCX52	-60
		BCX53	-80
<b>V<sub>EBO</sub></b>	Emitter-Base Voltage	-5	V
<b>I<sub>C</sub></b>	Collector Current	-1	A
<b>P<sub>C</sub></b>	Collector Power Dissipation	500	mW
<b>R<sub>θJA</sub></b>	Thermal Resistance From Junction To Ambient	250	°C/W
<b>T<sub>j</sub></b>	Junction Temperature	150	°C
<b>T<sub>stg</sub></b>	Storage Temperature	-55~+150	°C

**ELECTRICAL CHARACTERISTICS ( $T_a=25^\circ\text{C}$  unless otherwise specified)**

Parameter	Symbol	Test conditions	Min	Typ	Max	Unit	
Collector-base breakdown voltage	$V_{(BR)CBO}$	$I_C=-100\mu\text{A}, I_E=0$	BCX51	-45			V
			BCX52	-60			
			BCX53	-100			
Collector-emitter breakdown voltage	$V_{(BR)CEO^*}$	$I_C=-10\text{mA}, I_B=0$	BCX51	-45			V
			BCX52	-60			
			BCX53	-80			
Emitter-base breakdown voltage	$V_{(BR)EBO}$	$I_E=-100\mu\text{A}, I_C=0$	-5			V	
Collector cut-off current	$I_{CBO}$	$V_{CB}=-30\text{V}, I_E=0$			-0.1	$\mu\text{A}$	
Emitter cut-off current	$I_{EBO}$	$V_{EB}=-5\text{V}, I_C=0$			-0.1	$\mu\text{A}$	
DC current gain	$h_{FE(1)^*}$	$V_{CE}=-2\text{V}, I_C=-5\text{mA}$	63				
	$h_{FE(2)^*}$	$V_{CE}=-2\text{V}, I_C=-150\text{mA}$	63		250		
	$h_{FE(3)^*}$	$V_{CE}=-2\text{V}, I_C=-0.5\text{A}$	40				
Collector-emitter saturation voltage	$V_{CE(sat)^*}$	$I_C=-0.5\text{A}, I_B=-50\text{mA}$			-0.5	V	
Base-emitter voltage	$V_{BE^*}$	$V_{CE}=-2\text{V}, I_C=-0.5\text{A}$			-1	V	
Transition frequency	$f_T$	$V_{CE}=-5\text{V}, I_C=-10\text{mA}, f=100\text{MHz}$		50		MHz	

\* Pulse Test

**CLASSIFICATION OF  $h_{FE(2)}$**

<b>RANK</b>	<b>BCX51</b> <b>BCX52</b> <b>BCX53</b>	<b>BCX51-10</b> <b>BCX52-10</b> <b>BCX53-10</b>	<b>BCX51-16</b> <b>BCX52-16</b> <b>BCX53-16</b>
<b>RANGE</b>	63–250	63–160	100–250

# RATING AND CHARACTERISTICS CURVES (BCX51,BCX52,BCX53)

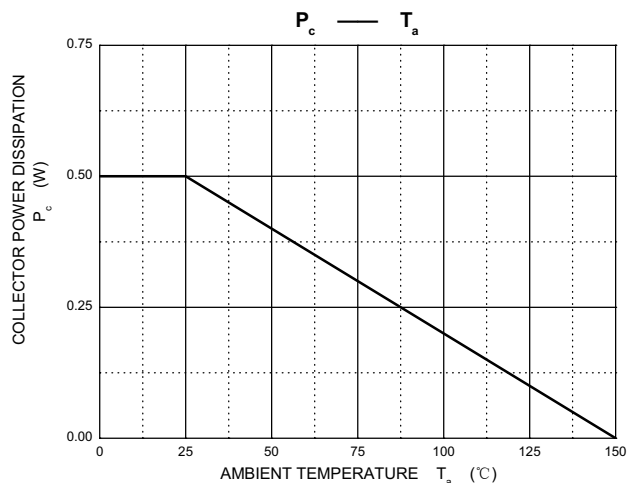
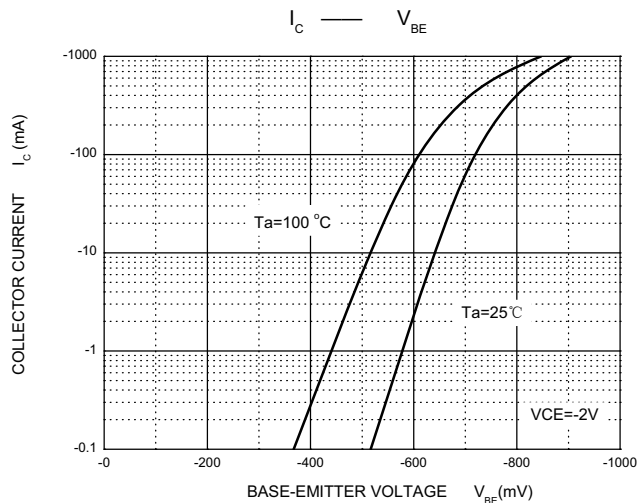
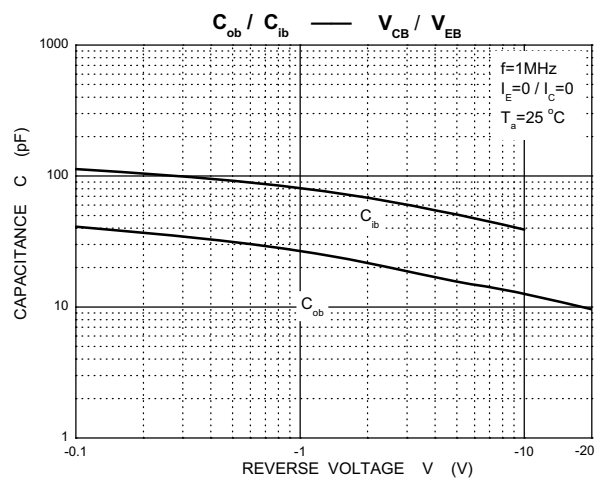
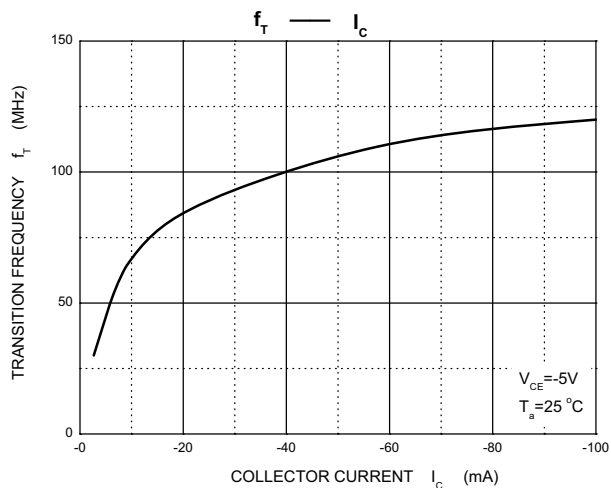
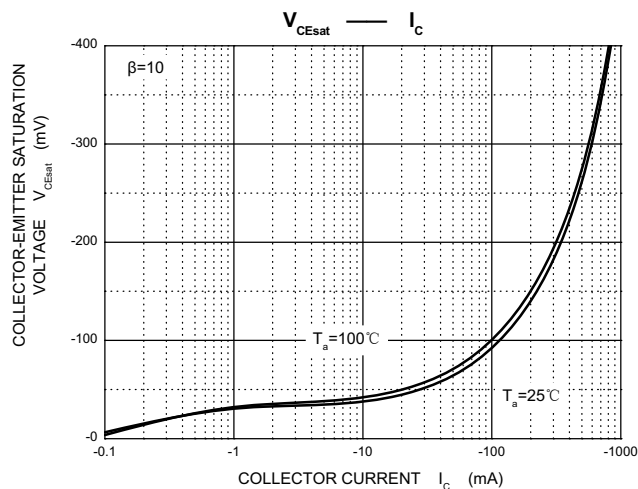
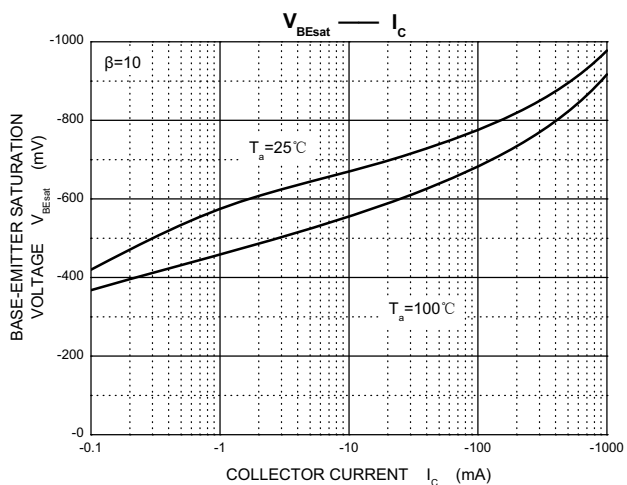
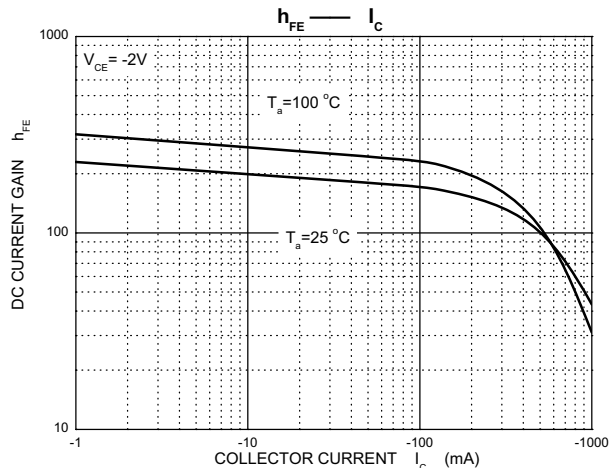
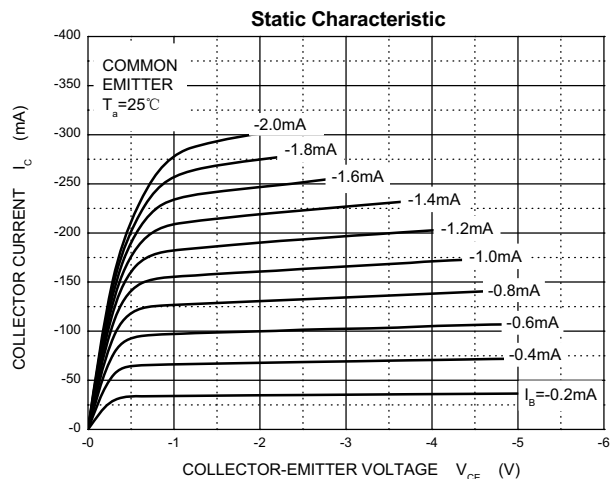

## SOT-89-3L Package Outline Dimensions

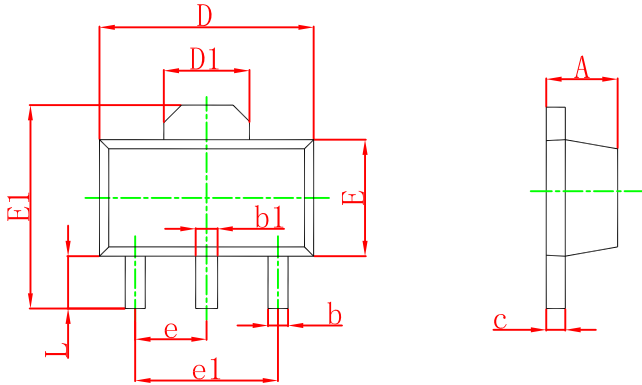

Symbol	Dimensions In Millimeters		Dimensions In Inches	
	Min	Max	Min	Max
A	1.400	1.600	0.055	0.063
b	0.320	0.520	0.013	0.020
b1	0.400	0.580	0.016	0.023
c	0.350	0.440	0.014	0.017
D	4.400	4.600	0.173	0.181
D1	1.550 REF.		0.061 REF.	
E	2.300	2.600	0.091	0.102
E1	3.940	4.250	0.155	0.167
e	1.500 TYP.		0.060 TYP.	
e1	3.000 TYP.		0.118 TYP.	
L	0.900	1.200	0.035	0.047

## SOT-89-3L Suggested Pad Layout

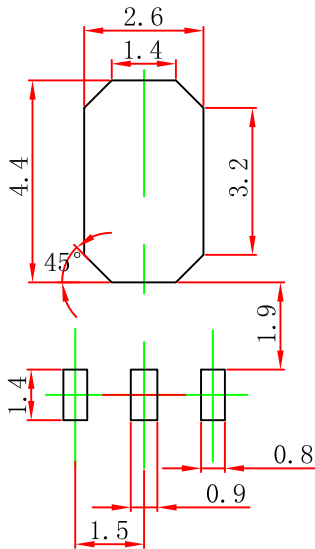

Note:

1. Controlling dimension: in millimeters.
2. General tolerance:  $\pm 0.05$  mm.
3. The pad layout is for reference purposes only.

# SOT-89-3L Tape and Reel

## SOT-89-3L Embossed Carrier Tape

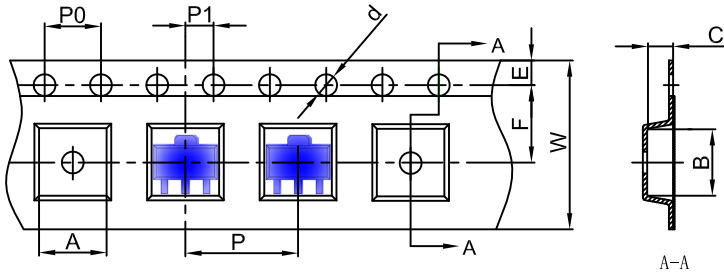

**Packaging Description:**  
 SOT-89-3L parts are shipped in tape. The carrier tape is made from a dissipative (carbon filled) polycarbonate resin. The cover tape is a multilayer film (Heat Activated Adhesive in nature) primarily composed of polyester film, adhesive layer, sealant, and anti-static sprayed agent. These reeled parts in standard option are shipped with 1,000 units per 7" or 18.0 cm diameter reel. The reels are clear in color and is made of polystyrene plastic (anti-static coated).

Dimensions are in millimeter										
Pkg type	A	B	C	d	E	F	P0	P	P1	W
SOT-89-3L	4.85	4.45	1.85	Ø1.50	1.75	5.50	4.00	8.00	2.00	12.00

## SOT-89-3L Tape Leader and Trailer

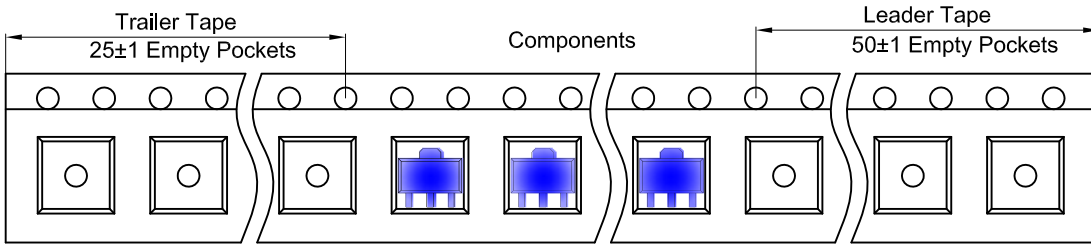

## SOT-89-3L Reel

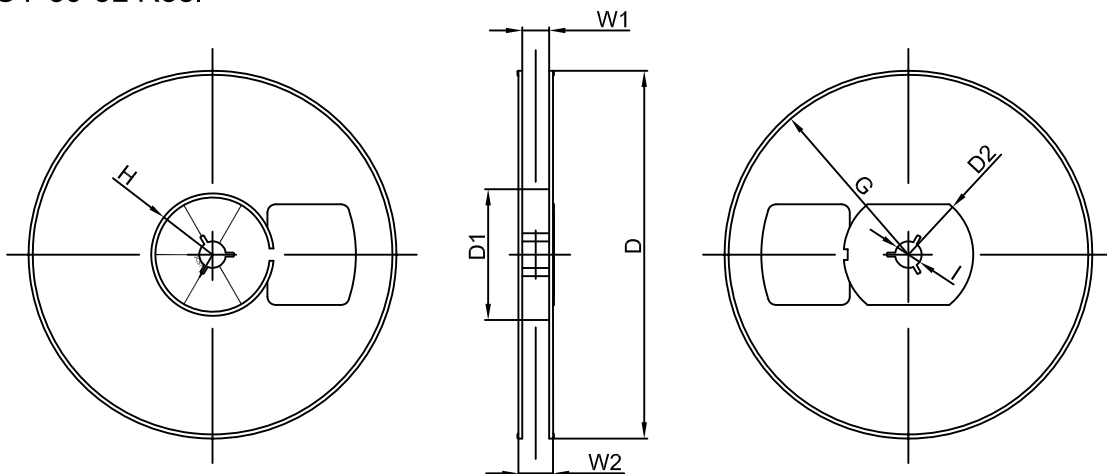

Dimensions are in millimeter								
Reel Option	D	D1	D2	G	H	I	W1	W2
7" Dia	Ø180.00	60.00	R32.00	R86.50	R30.00	Ø13.00	13.20	16.50

REEL	Reel Size	Box	Box Size(mm)	Carton	Carton Size(mm)	G.W.(kg)
1000 pcs	7 inch	10,000 pcs	203×203×195	40,000 pcs	438×438×220	

## DISCLAIMER NOTICE

Rectron Inc reserves the right to make changes without notice to any product specification herein, to make corrections, modifications, enhancements or other changes. Rectron Inc or anyone on its behalf assumes no responsibility or liability for any errors or inaccuracies. Data sheet specifications and its information contained are intended to provide a product description only. "Typical" parameters which may be included on RECTRON data sheets and/ or specifications can and do vary in different applications and actual performance may vary over time. Rectron Inc does not assume any liability arising out of the application or use of any product or circuit.

Rectron products are not designed, intended or authorized for use in medical, life-saving implant or other applications intended for life-sustaining or other related applications where a failure or malfunction of component or circuitry may directly or indirectly cause injury or threaten a life without expressed written approval of Rectron Inc. Customers using or selling Rectron components for use in such applications do so at their own risk and shall agree to fully indemnify Rectron Inc and its subsidiaries harmless against all claims, damages and expenditures.