

## CMOS 8-Stage Shift-and-Store Bus Register

High-Voltage Types (20-Volt Rating)

■ CD4094B is an 8-stage serial shift register having a storage latch associated with each stage for strobing data from the serial input to parallel buffered 3-state outputs. The parallel outputs may be connected directly to common bus lines. Data is shifted on positive clock transitions. The data in each shift register stage is transferred to the storage register when the STROBE input is high. Data in the storage register appears at the outputs whenever the OUTPUT-ENABLE signal is high.

Two serial outputs are available for cascading a number of CD4094B devices. Data is available at the Q<sub>S</sub> serial output terminal on positive clock edges to allow for high-speed operation in cascaded systems in which the clock rise time is fast. The same serial information, available at the Q<sub>S</sub> terminal on the next negative clock edge, provides a means for cascading CD4094B devices when the clock rise time is slow.

The CD4094B types are supplied in 16-lead hermetic dual-in-line ceramic packages (D and F suffixes), 16-lead dual-in-line plastic package (E suffix), 16-lead small-outline package (NSR suffix), and in chip form (H suffix).

### Features:

- 3-state parallel outputs for connection to common bus
- Separate serial outputs synchronous to both positive and negative clock edges for cascading
- Medium speed operation - 5 MHz at 10 V (typ.)
- Standardized, symmetrical output characteristics
- 100% tested for quiescent current at 20 V
- Maximum input current of 1  $\mu$ A at 18 V over full package-temperature range; 100 nA at 18 V and 25°C
- Noise margin (full package temperature range):  
1 V at V<sub>DD</sub> = 5 V      2 V at V<sub>DD</sub> = 10 V  
2.5 V at V<sub>DD</sub> = 15 V
- 5-V, 10-V, and 15-V parametric ratings
- Meets all requirements of JEDEC Tentative Standard No. 13B, "Standard Specifications for Description of 'B' Series CMOS Devices"

### Applications:

- Serial-to-parallel data conversion
- Remote control holding register
- Dual-rank shift, hold, and bus applications

### MAXIMUM RATINGS, Absolute-Maximum Values:

DC SUPPLY-VOLTAGE RANGE, (V <sub>DD</sub> )	.....	-0.5V to +20V
Voltages referenced to V <sub>SS</sub> Terminal)	.....	
INPUT VOLTAGE RANGE, ALL INPUTS	.....	-0.5V to V <sub>DD</sub> + 0.5V
DC INPUT CURRENT, ANY ONE INPUT	.....	±10mA
POWER DISSIPATION PER PACKAGE (P <sub>D</sub> ):		
For T <sub>A</sub> = -55°C to +100°C	.....	500mW
For T <sub>A</sub> = +100°C to +125°C	.....	Derate Linearly at 12mW/°C to 200mW
DEVICE DISSIPATION PER OUTPUT TRANSISTOR		
FOR T <sub>A</sub> = FULL PACKAGE-TEMPERATURE RANGE (All Package Types)	.....	100mW
OPERATING-TEMPERATURE RANGE (T <sub>A</sub> )	.....	-55°C to +125°C
STORAGE TEMPERATURE RANGE (T <sub>stg</sub> )	.....	-65°C to +150°C
LEAD TEMPERATURE (DURING SOLDERING):		
At distance 1/16 ± 1/32 inch (1.59 ± 0.79mm) from case for 10s max	.....	+265°C

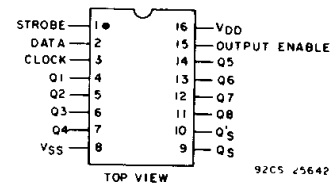
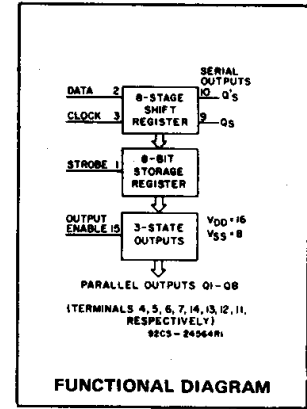

Fig. 1 - Terminal assignment.

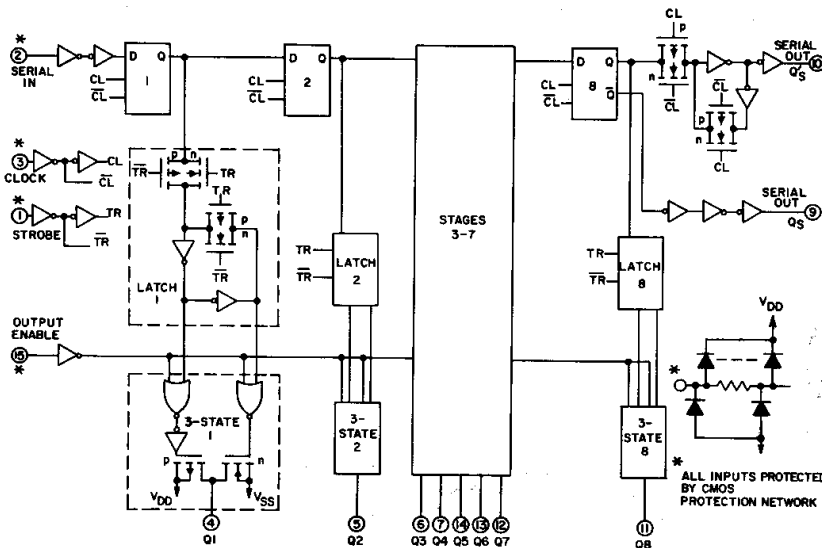

Fig. 2 - CD4094B Logic diagram.

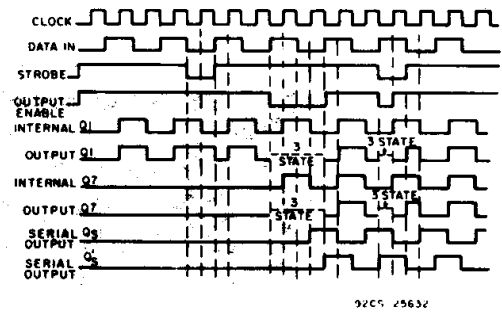

Fig. 3 - Timing diagram.

# CD4094B Types

**RECOMMENDED OPERATING CONDITIONS at  $T_A = 25^\circ\text{C}$ , Except as Noted.**  
 For maximum reliability, nominal operating conditions should be selected so that operation is always within the following ranges:

CHARACTERISTIC	VDD (V)	LIMITS		UNITS
		MIN.	MAX.	
Supply-Voltage Range (For $T_A$ =Full Package-Temperature Range)		3	18	V
Data Setup Time, $t_S$	5	125	—	ns
	10	55	—	
	15	35	—	
Clock Pulse Width, $t_W$	5	200	—	ns
	10	100	—	
	15	83	—	
Clock Input Frequency, $f_{CL}$	5		1.25	MHz
	10	dc	2.5	
	15		3	
Clock Input Rise or Fall time, $t_{rCL}, t_{fCL}$ *	5		15	$\mu\text{s}$
	10	—	5	
	15		5	
Strobe Pulse Width, $t_W$	5	200	—	ns
	10	80	—	
	15	70	—	

\*If more than one unit is cascaded  $t_{rCL}$  (for  $Q_S$  only) should be made less than or equal to the sum of the fixed propagation delay at 50 pF and the transition time of the output driving stage for the estimated capacitive load.

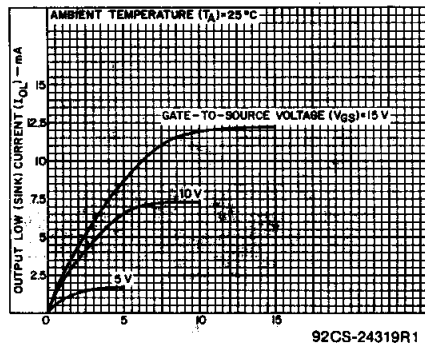

Fig. 5 - Minimum output low (sink) current characteristics.

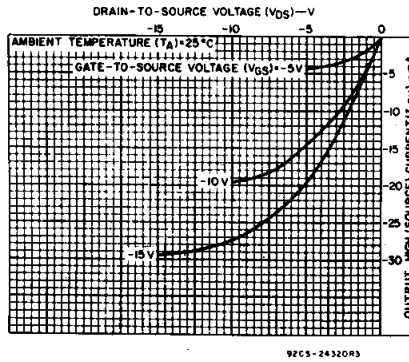

Fig. 6 - Typical output high (source) current characteristics.

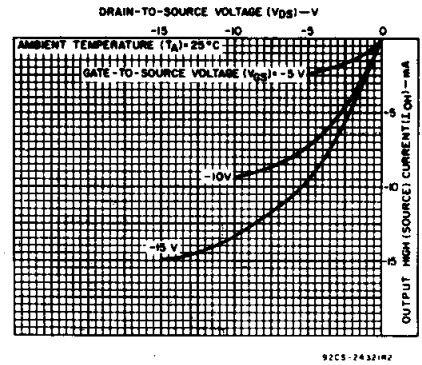

Fig. 7 - Minimum output high (source) current characteristics.

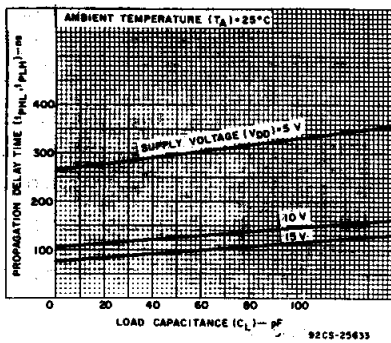

Fig. 8 - Clock-to-serial output  $Q_S$  propagation delay vs  $C_L$ .

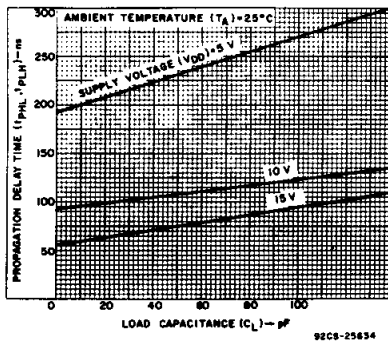

Fig. 9 - Clock-to-serial output  $Q'_S$  propagation delay vs  $C_L$ .

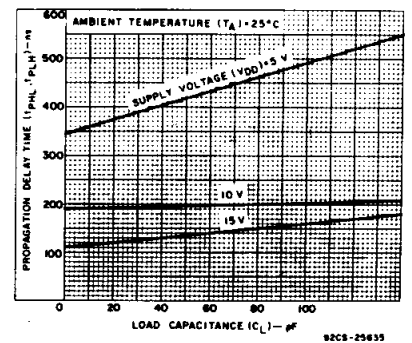

Fig. 10 - Clock-to-parallel output propagation delay vs  $C_L$ .

TRUTH TABLE

CL <sup>▲</sup>	Output Enable	Strobe	Data	Parallel Outputs		Serial Outputs	
				Q1	Q2	Q3*	Q4
[Symbol]	0	X	X	OC	OC	Q7	NC
	0	X	X	OC	OC	NC	Q7
[Symbol]	1	0	X	NC	NC	Q7	NC
	1	1	0	0	QN-1	Q7	NC
[Symbol]	1	1	1	1	QN-1	Q7	NC
	1	1	1	1	NC	NC	Q7

▲ = Level Change  
 X = Don't Care  
 NC = No Change  
 OC = Open Circuit  
 Logic 1  $\equiv$  High  
 Logic 0  $\equiv$  Low

\* At the positive clock edge information in the 7th shift register stage is transferred to the 8th register stage and the  $Q_S$  output.

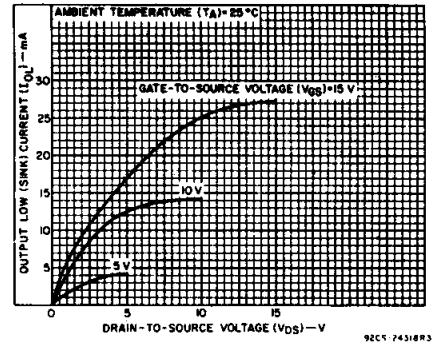

Fig. 4 - Typical output low (sink) current characteristics.

3  
 COMMERCIAL CMOS  
 HIGH VOLTAGE ICs

# CD4094B Types

## STATIC ELECTRICAL CHARACTERISTICS

CHARACTERISTIC	CONDITIONS			LIMITS AT INDICATED TEMPERATURES (°C)							UNITS		
	V <sub>O</sub> (V)	V <sub>IN</sub> (V)	V <sub>DD</sub> (V)							+25			
				-55	-40	+85	+125	Min.	Typ.	Max.			
Quiescent Device Current, I <sub>DD</sub> Max.	-	0.5	5	5	5	150	150	-	0.04	5	μA		
	-	0.10	10	10	10	300	300	-	0.04	10			
	-	0.15	15	20	20	600	600	-	0.04	20			
	-	0.20	20	100	100	3000	3000	-	0.08	100			
Output Low (Sink) Current, I <sub>OL</sub> Min.	0.4	0.5	5	0.64	0.61	0.42	0.36	0.51	1	-	mA		
	0.5	0.10	10	1.6	1.5	1.1	0.9	1.3	2.6	-			
	1.5	0.15	15	4.2	4	2.8	2.4	3.4	6.8	-			
Output High (Source) Current, I <sub>OH</sub> Min.	4.6	0.5	5	-0.64	-0.61	-0.42	-0.36	-0.51	-1	-	mA		
	2.5	0.5	5	-2	-1.8	-1.3	-1.15	-1.6	-3.2	-			
	9.5	0.10	10	-1.6	-1.5	-1.1	-0.9	-1.3	-2.6	-			
	13.5	0.15	15	-4.2	-4	-2.8	-2.4	-3.4	-6.8	-			
Output Voltage: Low-Level, V <sub>OL</sub> Max.	-	0.5	5	0.05			-	0	0.05	-	V		
	-	0.10	10	0.05			-	0	0.05	-			
	-	0.15	15	0.05			-	0	0.05	-			
Output Voltage: High-Level, V <sub>OH</sub> Min.	-	0.5	5	4.95			4.95	5	-	-	V		
	-	0.10	10	9.95			9.95	10	-	-			
	-	0.15	15	14.95			14.95	15	-	-			
Input Low Voltage, V <sub>IL</sub> Max.	0.5, 4.5	-	5	1.5			-	-	1.5	-	V		
	1.9	-	10	3			-	-	3	-			
	1.5, 13.5	-	15	4			-	-	4	-			
Input High Voltage, V <sub>IH</sub> Min.	0.5, 4.5	-	5	3.5			3.5	-	-	-	V		
	1.9	-	10	7			7	-	-	-			
	1.5, 13.5	-	15	11			11	-	-	-			
Input Current I <sub>IN</sub> Max.	-	0.18	18	±0.1	±0.1	±1	±1	-	±10 <sup>-5</sup>	±0.1	μA		
3-State Output Leakage Current I <sub>OUT</sub> Max.	0.18	0.18	18	±0.4	±0.4	±12	±12	-	±10 <sup>-4</sup>	±0.4	μA		

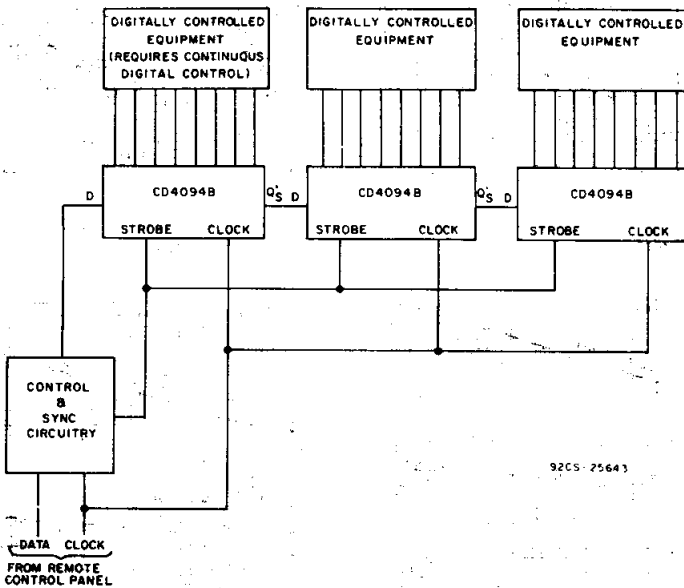

Fig. 14 - Remote control holding register.

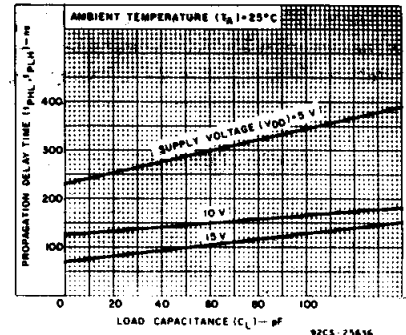

Fig. 11 - Strobe-to-parallel output propagation delay vs. C<sub>L</sub>.

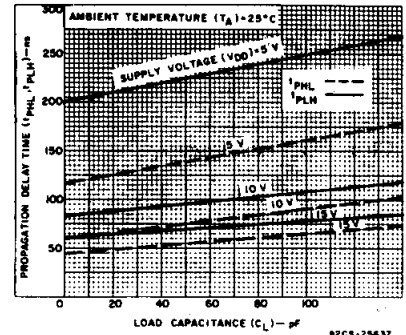

Fig. 12 - Output enable-to-parallel output propagation delay vs. C<sub>L</sub>.

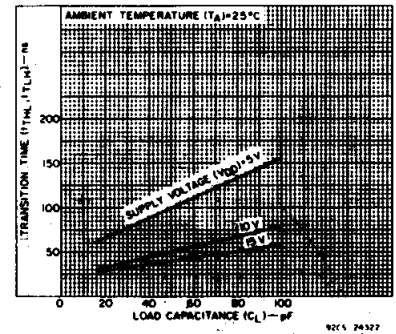

Fig. 13 - Typical transition time vs. load capacitance.

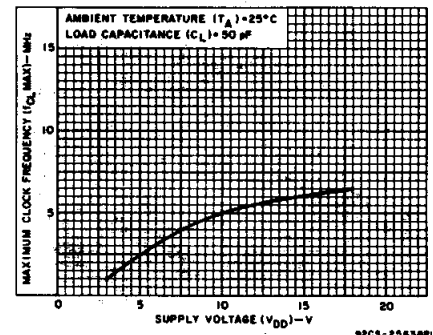

Fig. 15 - Typical maximum-clock-frequency vs. supply voltage.

# CD4094B Types

## DYNAMIC ELECTRICAL CHARACTERISTICS

At  $T_A = 25^\circ\text{C}$ ; Input  $t_r, t_f = 20\text{ ns}$ ,  $C_L = 50\text{ pF}$ ,  $R_L = 200\text{ k}\Omega$

CHARACTERISTIC	VDD (V)	LIMITS			UNITS
		MIN.	TYP.	MAX.	
Propagation Delay Time, $t_{PHL}, t_{PLH}$ Clock to Serial Output $Q_S$	5	—	300	600	ns
	10	—	125	250	
	15	—	95	190	
Clock to Serial Output $Q'_S$	5	—	230	460	ns
	10	—	110	220	
	15	—	75	150	
Clock to Parallel Output	5	—	420	840	ns
	10	—	195	390	
	15	—	135	270	
Strobe to Parallel Output	5	—	290	580	ns
	10	—	145	290	
	15	—	100	200	
Output Enable to Parallel Output: $t_{PHZ}, t_{PZH}$	5	—	140	280	ns
	10	—	60	120	
	15	—	45	90	
$t_{PLZ}, t_{PZL}$	5	—	100	200	ns
	10	—	50	100	
	15	—	40	80	
Minimum Strobe Pulse Width, $t_W$	5	—	100	200	ns
	10	—	40	80	
	15	—	35	70	
Minimum Clock Pulse Width, $t_W$	5	—	100	200	ns
	10	—	50	100	
	15	—	40	83	
Minimum Data Setup Time, $t_S$	5	—	60	125	ns
	10	—	30	55	
	15	—	20	35	
Transition Time; $t_{THL}, t_{TLH}$	5	—	100	200	ns
	10	—	50	100	
	15	—	40	80	
Maximum Clock Input Rise or Fall Time, $t_{rCL}, t_{fCL}$	5	15	—	—	$\mu\text{s}$
	10	5	—	—	
	15	5	—	—	
Maximum Clock Input Frequency, $f_{CL}$	5	1.25	2.5	—	MHz
	10	2.5	5	—	
	15	3	6	—	
Input Capacitance $C_{iN}$ (Any Input)	—	—	5	7.5	pF

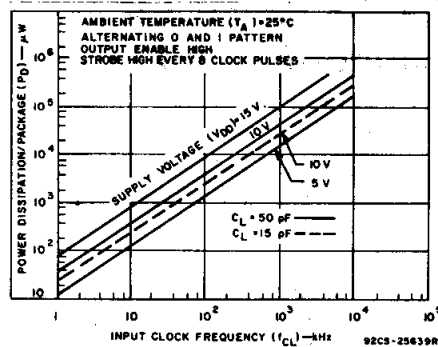

Fig. 16 — Dynamic power dissipation vs input clock frequency.

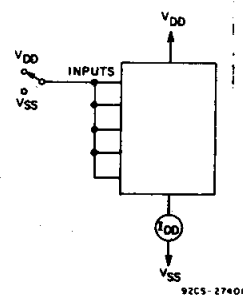

Fig. 17 — Quiescent device current test circuit.

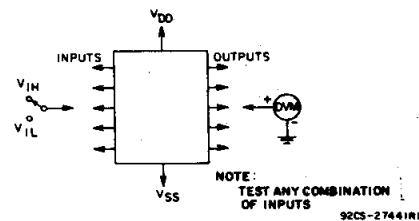

Fig. 18 — Input voltage test circuit.

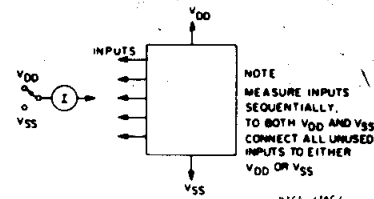
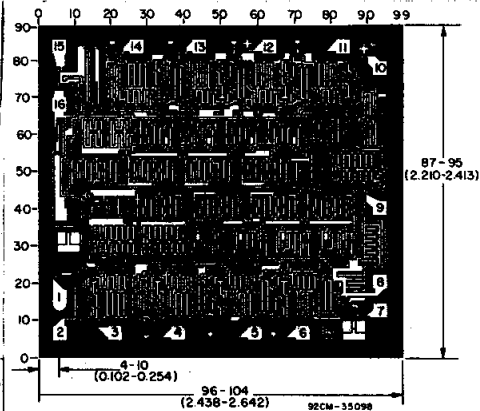

Fig. 19 — Input current test circuit.



Dimensions and Pad Layout for CD4094B Chip.

Dimensions in parentheses are in millimeters and are derived from the basic inch dimensions as indicated. Grid graduations are in mils ( $10^{-3}$  inch).

## IMPORTANT NOTICE

Texas Instruments Incorporated and its subsidiaries (TI) reserve the right to make corrections, modifications, enhancements, improvements, and other changes to its products and services at any time and to discontinue any product or service without notice. Customers should obtain the latest relevant information before placing orders and should verify that such information is current and complete. All products are sold subject to TI's terms and conditions of sale supplied at the time of order acknowledgment.

TI warrants performance of its hardware products to the specifications applicable at the time of sale in accordance with TI's standard warranty. Testing and other quality control techniques are used to the extent TI deems necessary to support this warranty. Except where mandated by government requirements, testing of all parameters of each product is not necessarily performed.

TI assumes no liability for applications assistance or customer product design. Customers are responsible for their products and applications using TI components. To minimize the risks associated with customer products and applications, customers should provide adequate design and operating safeguards.

TI does not warrant or represent that any license, either express or implied, is granted under any TI patent right, copyright, mask work right, or other TI intellectual property right relating to any combination, machine, or process in which TI products or services are used. Information published by TI regarding third-party products or services does not constitute a license from TI to use such products or services or a warranty or endorsement thereof. Use of such information may require a license from a third party under the patents or other intellectual property of the third party, or a license from TI under the patents or other intellectual property of TI.

Reproduction of information in TI data books or data sheets is permissible only if reproduction is without alteration and is accompanied by all associated warranties, conditions, limitations, and notices. Reproduction of this information with alteration is an unfair and deceptive business practice. TI is not responsible or liable for such altered documentation.

Resale of TI products or services with statements different from or beyond the parameters stated by TI for that product or service voids all express and any implied warranties for the associated TI product or service and is an unfair and deceptive business practice. TI is not responsible or liable for any such statements.

### Mailing Address:

Texas Instruments  
Post Office Box 655303  
Dallas, Texas 75265



REAL WORLD SIGNAL PROCESSING™

Search TI

[PRODUCTS](#) ▶ [APPLICATIONS](#) ▶ [SUPPORT](#) ▶ [TI&ME](#) ▶

[Advanced Search](#)

**PRODUCT FOLDER** | PRODUCT INFO: [FEATURES](#) | [DESCRIPTION](#) | [DATASHEETS](#) | [PRICING/AVAILABILITY/PKG](#) | [SAMPLES](#)  
 | [APPLICATION NOTES](#) | [RELATED DOCUMENTS](#)

PRODUCT SUPPORT: [TRAINING](#)

## CD4094B, CMOS 8-Stage Shift-and-Store Bus Register

DEVICE STATUS: **ACTIVE**

PARAMETER NAME	CD4094B
Voltage Nodes (V)	5, 10, 15

### FEATURES

[Back to Top](#)

- 3-state parallel outputs for connection to common bus
- Separate serial outputs synchronous to both positive and negative clock edges for cascading
- Medium speed operation - 5 MHz at 10 V (typ.)
- Standardized, symmetrical output characteristics
- 100% tested for quiescent current at 20 V
- Maximum input current of 1 uA at 18 V over full package-temperature range; 100 nA at 18 V and 25°C
- Noise margin (full package temperature range):
  - 1 V at  $V_{DD} = 5$  V
  - 2 V at  $V_{DD} = 10$  V
  - 2.5 V at  $V_{DD} = 15$  V
- 5-V, 10-V, and 15-V parametric ratings
- Meets all requirements of JEDEC Tentative Standard No. 13B, "Standard Specifications for Description of 'B' Series CMOS Devices"
- Applications
  - Serial-to-parallel data conversion
  - Remote control holding register
  - Dual-rank shift, hold, and bus applications

### DESCRIPTION

[Back to Top](#)

CD4094B is an 8-stage serial shift register having a storage latch associated with each stage for strobing data from the serial input to parallel buffered 3-state outputs. The parallel outputs may be connected directly to common bus lines. Data is shifted on positive clock transitions. The data in each shift register stage is transferred to the storage register when the STROBE input is high. Data in the storage register appears at the outputs whenever the OUTPUT-ENABLE signal is high.

Two serial outputs are available for cascading a number of CD4094B devices. Data is available at the  $Q_S$  serial output terminal on positive clock edges to allow for high-speed operation in cascaded systems in which the clock rise time is fast. The same serial information, available at the  $Q'_S$  terminal on the next negative clock edge, provides a means for cascading CD4094B devices when the clock rise time is slow.

The CD4094B types are supplied in 16-lead hermetic dual-in-line ceramic packages (D and F suffixes), 16-lead dual-in-line plastic package (E suffix), 16-lead small-outline package (NSR suffix), and in chip form (H suffix).

### TECHNICAL RESOURCES

[Back to Top](#)

To view the following documents, [Acrobat Reader 4.0](#) is required.

To download a document to your hard drive, right-click on the link and choose 'Save'.

### DATASHEET

[Back to Top](#)

Full datasheet in Acrobat PDF: [cd4094b.pdf](#) (271 KB, Rev. A) (Updated: 03/15/2002)**APPLICATION NOTES**[▲ Back to Top](#)View Application Reports for [Digital Logic](#)

- [Evaluation of Nickel/Palladium/Gold-Finished Surface-Mount Integrated Circuits](#) (SZZA026 - Updated: 06/20/2001)

**RELATED DOCUMENTS**[▲ Back to Top](#)

- [Advanced Bus Interface Logic Selection Guide](#) (SCYT126, 448 KB - Updated: 01/09/2001)
- [Documentation Rules \(SAP\) And Ordering Information \(Rev. B\)](#) (SZZU001B, 13 KB - Updated: 05/06/1999)
- [Logic Selection Guide First Half 2002 \(Rev. Q\)](#) (SDYU001Q, 3368 KB - Updated: 12/17/2001)
- [MicroStar Junior BGA Design Summary](#) (SCET004, 167 KB - Updated: 07/28/2000)
- [More Power In Less Space - Technical Article \(Rev. A\)](#) (SCAU001A, 850 KB - Updated: 03/01/1996)
- [Overview of IEEE Std 91-1984, Explanation of Logic Symbols Training Booklet \(Rev. A\)](#) (SDYZ001A, 138 KB - Updated: 07/01/1996)

**SAMPLES**[▲ Back to Top](#)

ORDERABLE DEVICE	PACKAGE	PINS	TEMP (°C)	STATUS	DSCC NUMBER	SAMPLES
CD4094BE	<a href="#">N</a>	16	-55 TO 125	ACTIVE		<a href="#">Request Samples</a>

**PRICING/AVAILABILITY/PKG**[▲ Back to Top](#)

ORDERABLE DEVICE	PACKAGE	PINS	TEMP (°C)	STATUS	BUDGETARY PRICE US\$/UNIT QTY=1000+	PACK QTY	DSCC NUMBER	PRICING/AVAILABILITY/PKG
CD4094BE	<a href="#">N</a>	16	-55 TO 125	ACTIVE	0.29	25		<a href="#">Check stock or order</a>
CD4094BF	<a href="#">J</a>	16	-55 TO 125	ACTIVE	2.77	1		<a href="#">Check stock or order</a>
CD4094BF3A	<a href="#">J</a>	16	-55 TO 125	ACTIVE	3.28	1	7702501EA	<a href="#">Check stock or order</a>
CD4094BNSR	<a href="#">NS</a>	16	-55 TO 125	ACTIVE	0.49	2000		<a href="#">Check stock or order</a>
CD4094BPW	<a href="#">PW</a>	16	-55 TO 125	OBSOLETE				
CD4094BPWR	<a href="#">PW</a>	16	-55 TO 125	ACTIVE	0.29	2000		<a href="#">Check stock or order</a>

Table Data Updated on: 5/1/2002

[Products](#) | [Applications](#) | [Support](#) | [TI&ME](#) TEXAS INSTRUMENTS © Copyright 1995-2002 Texas Instruments Incorporated. All rights reserved.[Trademarks](#) | [Privacy Policy](#) | [Terms of Use](#)