

## GPO Blindmate Interconnects

Catalog Number  
A1A1-0001-02

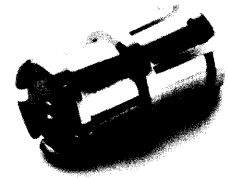
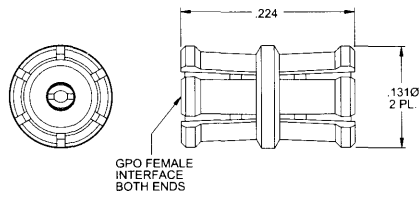

Female Blindmate Interconnect  
0.224 R/P to R/P

## GPO Within Series Adapters

Catalog Number	A
A1A3-0503-01	FD
A1A4-0503-01	LD
A1A5-0503-01	SB

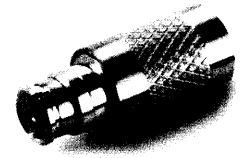
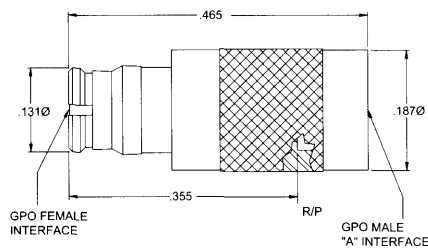

F-M Within Series Adapter

Catalog Number	A	B
A3A3-0539-01	FD	FD
A3A6-0539-01	CM	FD

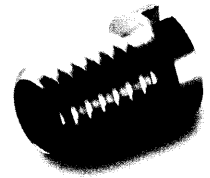
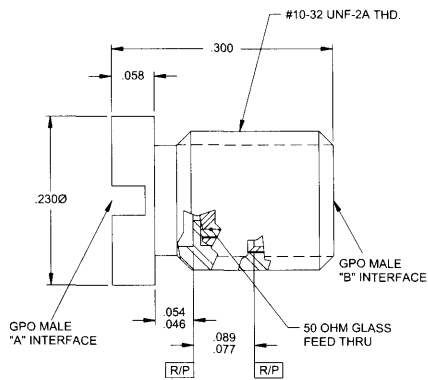

M-M Within Series Adapter

## GPO Between Series Adapters

Catalog Number	A
1A3C1-0503-01	FD

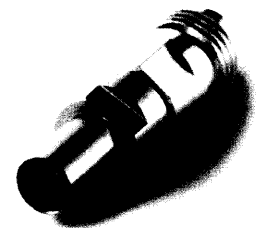
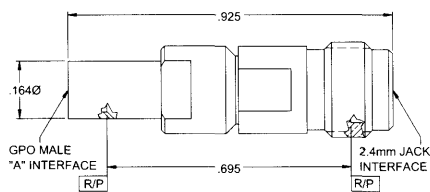

GPO to 2.4mm M-F Adapter