

Optocoupler, Phototransistor Output, With Base Connection

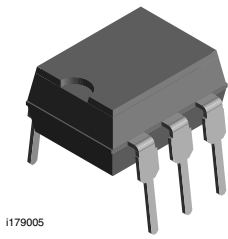

H179005

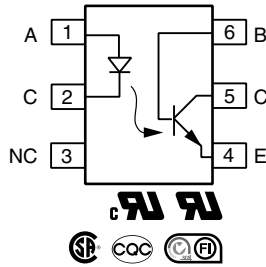

FEATURES

- Current transfer ratio (see order information)
- Isolation test voltage 4420 V_{RMS}
- Material categorization: for definitions of compliance please see www.vishay.com/doc?99912

RoHS
COMPLIANT

AGENCY APPROVALS

- [UL / cUL](#) 1577
- [CSA](#)
- [CQC GB4943.1-2011](#)
- [CQC GB8898-2011](#)
- [FIMKO](#)

LINKS TO ADDITIONAL RESOURCES



DESCRIPTION

The IL2 is an optically coupled isolated pairs employing GaAs infrared LEDs and silicon NPN phototransistor. Signal information, including a DC level, can be transmitted by the drive while maintaining a high degree of electrical isolation between input and output. The IL2 is especially designed for driving medium-speed logic and can be used to eliminate troublesome ground loop and noise problems. This coupler can be used also to replace relays and transformers in many digital interface applications such as CRT modulation.

ORDERING INFORMATION	
<div style="display: flex; justify-content: space-around; align-items: center;"> <div style="border: 1px solid black; padding: 2px 5px;">I</div> <div style="border: 1px solid black; padding: 2px 5px;">L</div> <div style="border: 1px solid black; padding: 2px 5px;">2</div> <div style="border: 1px solid black; padding: 2px 5px;">-</div> <div style="border: 1px solid black; padding: 2px 5px;">X</div> <div style="border: 1px solid black; padding: 2px 5px;">0</div> <div style="border: 1px solid black; padding: 2px 5px;">0</div> <div style="border: 1px solid black; padding: 2px 5px;">9</div> <div style="border: 1px solid black; padding: 2px 5px;">T</div> </div> <p style="text-align: center;"> PART NUMBER PACKAGE OPTION PACKAGE OPTION </p>	
AGENCY CERTIFIED / PACKAGE	CTR (%)
UL, cUL, CSA, CQC, FIMKO	> 100
SMD-6, option 9	IL2-X009T

Note

- Additional options may be possible, please contact sales office

ABSOLUTE MAXIMUM RATINGS (T _{amb} = 25 °C, unless otherwise specified)				
PARAMETER	TEST CONDITION	SYMBOL	VALUE	UNIT
INPUT				
Reverse voltage		V _R	6	V
Forward current		I _F	60	mA
Surge current		I _{FSM}	2.5	A
Power dissipation		P _{diss}	100	mW
Derate linearly from 25 °C			1.33	mW/°C



ABSOLUTE MAXIMUM RATINGS ($T_{amb} = 25\text{ }^{\circ}\text{C}$, unless otherwise specified)				
PARAMETER	TEST CONDITION	SYMBOL	VALUE	UNIT
OUTPUT				
Collector emitter breakdown voltage		BV_{CEO}	70	V
Emitter base breakdown voltage		BV_{EBO}	7	V
Collector base breakdown voltage		BV_{CBO}	70	V
Collector current		I_C	50	mA
	$t < 1.0\text{ ms}$	I_C	400	mA
Power dissipation		P_{diss}	200	mW
Derate linearly from 25 °C			2.6	mW/°C
COUPLER				
Package power dissipation		P_{tot}	250	mW
Derate linearly from 25 °C			3.3	mW/°C
Storage temperature		T_{stg}	-40 to +150	°C
Operating temperature		T_{amb}	-40 to +100	°C
Junction temperature		T_j	125	°C
Soldering temperature ⁽¹⁾	2.0 mm from case bottom	T_{sld}	260	°C

Notes

- Stresses in excess of the absolute maximum ratings can cause permanent damage to the device. Functional operation of the device is not implied at these or any other conditions in excess of those given in the operational sections of this document. Exposure to absolute maximum ratings for extended periods of the time can adversely affect reliability
- ⁽¹⁾ Refer to reflow profile for soldering conditions for surface mounted devices (SMD). Refer to wave profile for soldering conditions for through hole devices (DIP)

ELECTRICAL CHARACTERISTICS ($T_{amb} = 25\text{ }^{\circ}\text{C}$, unless otherwise specified)						
PARAMETER	TEST CONDITION	SYMBOL	MIN.	TYP.	MAX.	UNIT
INPUT						
Forward voltage	$I_F = 60\text{ mA}$	V_F	-	1.25	1.65	V
Breakdown voltage	$I_R = 10\text{ }\mu\text{A}$	V_{BR}	6	30	-	V
Reverse current	$V_R = 6.0\text{ V}$	I_R	-	0.01	10	μA
Capacitance	$V_R = 0\text{ V}$, $f = 1.0\text{ MHz}$	C_O	-	40	-	pF
Thermal resistance junction to lead		R_{thjl}	-	750	-	K/W
OUTPUT						
Collector emitter capacitance	$V_{CE} = 5.0\text{ V}$, $f = 1.0\text{ MHz}$	C_{CE}	-	6.8	-	pF
Collector base capacitance	$V_{CB} = 5.0\text{ V}$, $f = 1.0\text{ MHz}$	C_{CB}	-	8.5	-	pF
Emitter base capacitance	$V_{EB} = 5.0\text{ V}$, $f = 1.0\text{ MHz}$	C_{EB}	-	11	-	pF
Collector emitter leakage voltage	$V_{CE} = 10\text{ V}$	I_{CEO}	-	5	50	nA
Collector emitter saturation voltage	$I_{CE} = 1.0\text{ mA}$, $I_B = 20\text{ }\mu\text{A}$	V_{CEsat}	-	0.25	-	V
Base emitter voltage	$V_{CE} = 10\text{ V}$, $I_B = 20\text{ }\mu\text{A}$	V_{BE}	-	0.65	-	V
DC forward current gain	$V_{CE} = 10\text{ V}$, $I_B = 20\text{ }\mu\text{A}$	h_{FE}	200	650	1800	
DC forward current gain saturated	$V_{CE} = 0.4\text{ V}$, $I_B = 20\text{ }\mu\text{A}$	h_{FEsat}	120	400	600	
Thermal resistance junction to lead		R_{thjl}	-	500	-	K/W
COUPLER						
Capacitance (input to output)	$V_{I-O} = 0\text{ V}$, $f = 1.0\text{ MHz}$	C_{IO}	-	0.6	-	pF
Insulation resistance	$V_{I-O} = 500\text{ V}$	R_S	-	10^{14}	-	Ω

Note

- Minimum and maximum values are testing requirements. Typical values are characteristics of the device and are the result of engineering evaluation. Typical values are for information only and are not part of the testing requirements



CURRENT TRANSFER RATIO						
PARAMETER	TEST CONDITION	SYMBOL	MIN.	TYP.	MAX.	UNIT
Current transfer ratio (collector emitter saturated)	$I_F = 10 \text{ mA}, V_{CE} = 0.4 \text{ V}$	CTR_{CEsat}	-	170	-	%
Current transfer ratio (collector emitter)	$I_F = 10 \text{ mA}, V_{CE} = 10 \text{ V}$	CTR_{CE}	100	200	500	%
Current transfer ratio (collector base)	$I_F = 10 \text{ mA}, V_{CB} = 9.3 \text{ V}$	CTR_{CB}	-	0.25	-	%

SWITCHING CHARACTERISTICS						
PARAMETER	TEST CONDITION	SYMBOL	MIN.	TYP.	MAX.	UNIT
NON-SATURATED						
Current time	$V_{CE} = 5 \text{ V}, R_L = 75 \Omega$, t_p measured at 50 % of output	I_F	-	4	-	mA
Delay time	$V_{CE} = 5 \text{ V}, R_L = 75 \Omega$, t_p measured at 50 % of output	t_D	-	1.7	-	μs
Rise time	$V_{CE} = 5 \text{ V}, R_L = 75 \Omega$, t_p measured at 50 % of output	t_r	-	2.6	-	μs
Storage time	$V_{CE} = 5 \text{ V}, R_L = 75 \Omega$, t_p measured at 50 % of output	t_s	-	0.4	-	μs
Fall time	$V_{CE} = 5 \text{ V}, R_L = 75 \Omega$, t_p measured at 50 % of output	t_f	-	2.2	-	μs
Propagation H to L	$V_{CE} = 5 \text{ V}, R_L = 75 \Omega$, t_p measured at 50 % of output	t_{PHL}	-	1.2	-	μs
Propagation L to H	$V_{CE} = 5 \text{ V}, R_L = 75 \Omega$, t_p measured at 50 % of output	t_{PLH}	-	2.3	-	μs
SATURATED						
Current time	$V_{CE} = 0.4 \text{ V}, R_L = 1.0 \text{ k}\Omega$, $V_{CL} = 5 \text{ V}, V_{TH} = 1.5 \text{ V}$	I_F	-	5	-	mA
Delay time	$V_{CE} = 0.4 \text{ V}, R_L = 1.0 \text{ k}\Omega$, $V_{CL} = 5 \text{ V}, V_{TH} = 1.5 \text{ V}$	t_D	-	1	-	μs
Rise time	$V_{CE} = 0.4 \text{ V}, R_L = 1.0 \text{ k}\Omega$, $V_{CL} = 5 \text{ V}, V_{TH} = 1.5 \text{ V}$	t_r	-	2	-	μs
Storage time	$V_{CE} = 0.4 \text{ V}, R_L = 1.0 \text{ k}\Omega$, $V_{CL} = 5 \text{ V}, V_{TH} = 1.5 \text{ V}$	t_s	-	5.4	-	μs
SATURATED						
Fall time	$V_{CE} = 0.4 \text{ V}, R_L = 1.0 \text{ k}\Omega$, $V_{CL} = 5 \text{ V}, V_{TH} = 1.5 \text{ V}$	t_f	-	13.5	-	μs
Propagation H to L	$V_{CE} = 0.4 \text{ V}, R_L = 1.0 \text{ k}\Omega$, $V_{CL} = 5 \text{ V}, V_{TH} = 1.5 \text{ V}$	t_{PHL}	-	5.4	-	μs
Propagation L to H	$V_{CE} = 0.4 \text{ V}, R_L = 1.0 \text{ k}\Omega$, $V_{CL} = 5 \text{ V}, V_{TH} = 1.5 \text{ V}$	t_{PLH}	-	7.4	-	μs

COMMON MODE TRANSIENT IMMUNITY						
PARAMETER	TEST CONDITION	SYMBOL	MIN.	TYP.	MAX.	UNIT
Common mode rejection output high	$V_{CM} = 50 \text{ V}_{P-P}, R_L = 1 \text{ k}\Omega, I_F = 10 \text{ mA}$	$ CM_H $	-	5000	-	V/ μs
Common mode rejection output low	$V_{CM} = 50 \text{ V}_{P-P}, R_L = 1 \text{ k}\Omega, I_F = 10 \text{ mA}$	$ CM_L $	-	5000	-	V/ μs
Common mode coupling capacitance		C_{CM}	-	0.01	-	pF



SAFETY AND INSULATION RATINGS				
PARAMETER	TEST CONDITION	SYMBOL	VALUE	UNIT
Climatic classification	According to IEC 68 part 1		40 / 100 / 21	
Comparative tracking index		CTI	175	
Maximum rated withstanding isolation voltage	t = 1 min	V _{ISO}	4420	V _{RMS}
Maximum transient isolation voltage		V _{IOTM}	10 000	V _{peak}
Maximum repetitive peak isolation voltage		V _{IORM}	890	V _{peak}
Isolation resistance	V _{IO} = 500 V, T _{amb} = 25 °C	R _{IO}	≥ 10 ¹²	Ω
	V _{IO} = 500 V, T _{amb} = 100 °C	R _{IO}	≥ 10 ¹¹	Ω
Output safety power		P _{SO}	400	mW
Input safety current		I _{SI}	275	mA
Safety temperature		T _S	175	°C
Creepage distance			≥ 7	mm
Clearance distance			≥ 7	mm
Insulation thickness		DTI	≥ 0.4	mm

Note

- As per IEC 60747-5-5, § 7.4.3.8.2, this optocoupler is suitable for “safe electrical insulation” only within the safety ratings. Compliance with the safety ratings shall be ensured by means of protective circuits

TYPICAL CHARACTERISTICS ($T_{amb} = 25\text{ }^{\circ}\text{C}$, unless otherwise specified)

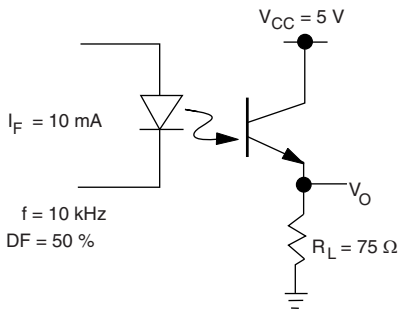

iii1_01

Fig. 1 - Non-Saturated Switching Schematic

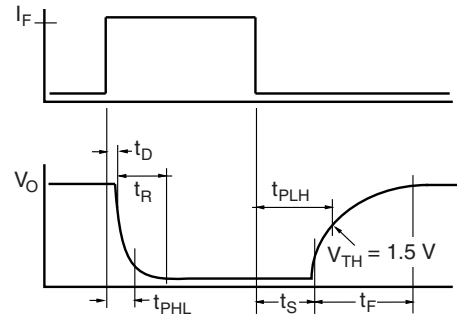

iii1_04

Fig. 4 - Saturated Switching Timing

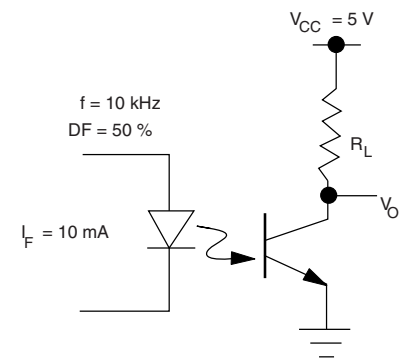

iii1_02

Fig. 2 - Saturated Switching Schematic

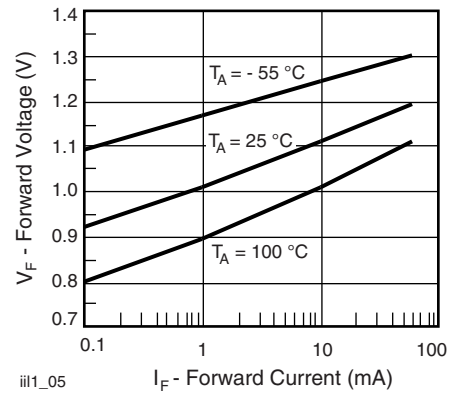

iii1_05

Fig. 5 - Forward Voltage vs. Forward Current

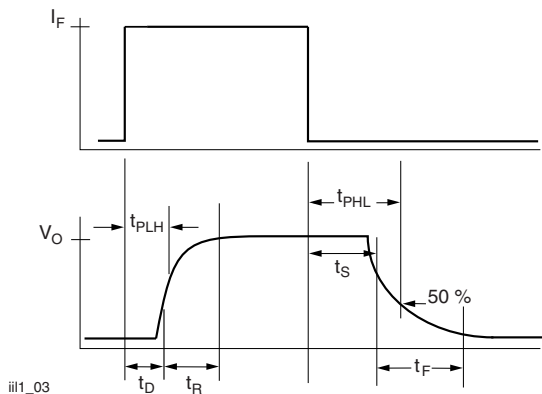

iii1_03

Fig. 3 - Non-Saturated Switching Timing

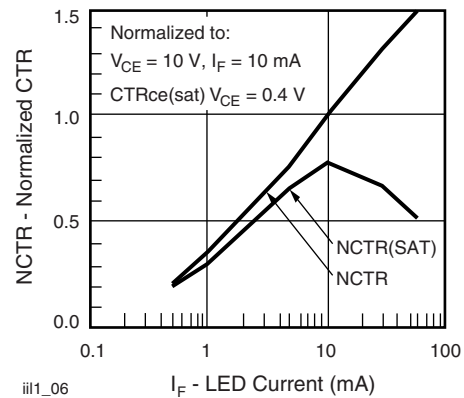

iii1_06

Fig. 6 - Normalized Non-Saturated and Saturated CTR vs. LED Current

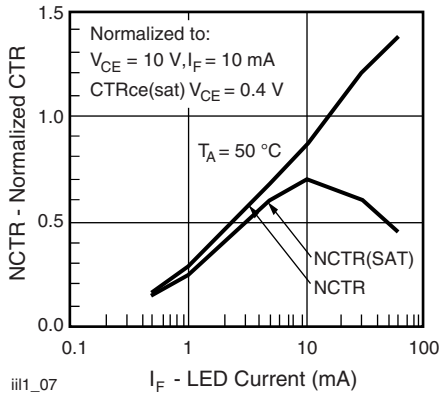

Fig. 7 - Normalized Non-Saturated and Saturated CTR vs. LED Current

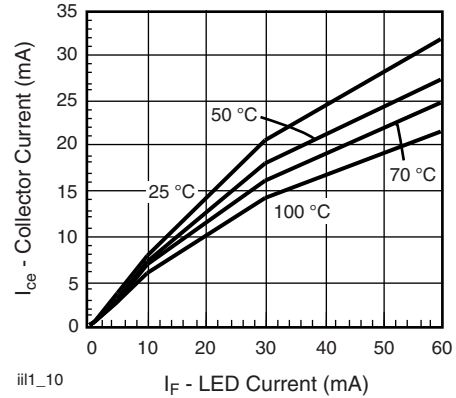

Fig. 10 - Collector Emitter Current vs. Temperature and LED Current

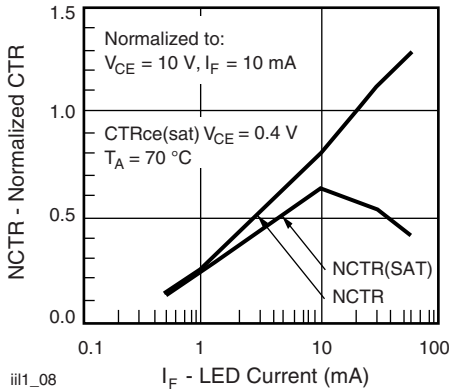

Fig. 8 - Normalized Non-Saturated and Saturated CTR vs. LED Current

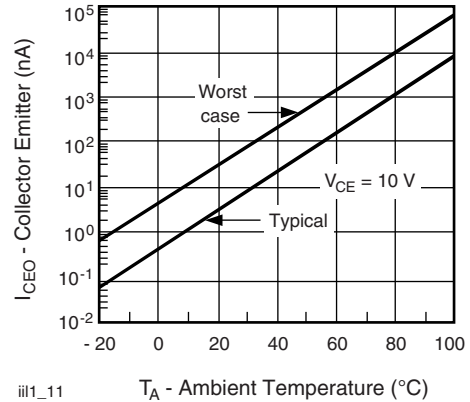

Fig. 11 - Collector Emitter Leakage Current vs. Temperature

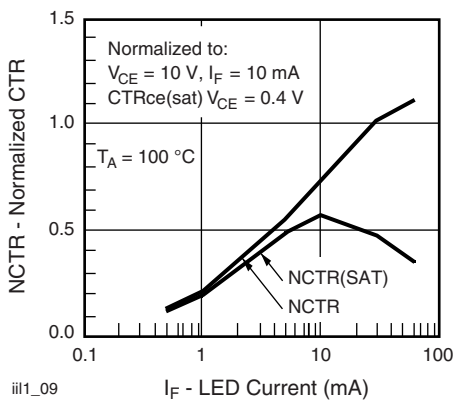

Fig. 9 - Normalized Non-Saturated and Saturated CTR, $T_{amb} = 100\text{ °C}$ vs. LED Current

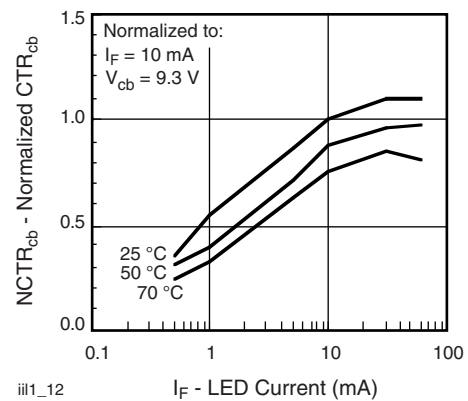

Fig. 12 - Normalized CTR_{cb} vs. LED Current and Temperature

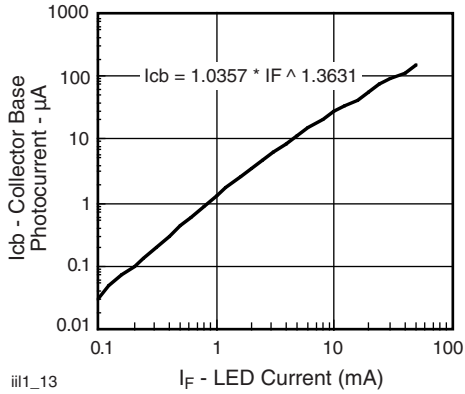

Fig. 13 - Collector Base Photocurrent vs. LED Current

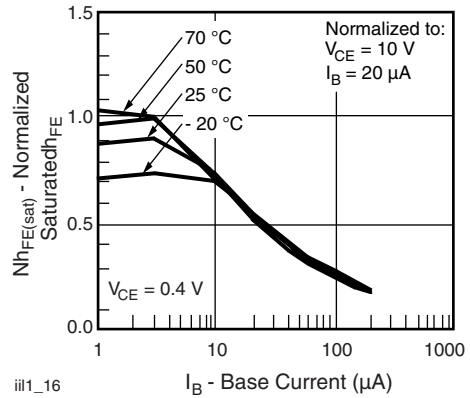

Fig. 16 - Normalized Saturated h_{FE} vs. Base Current and Temperature

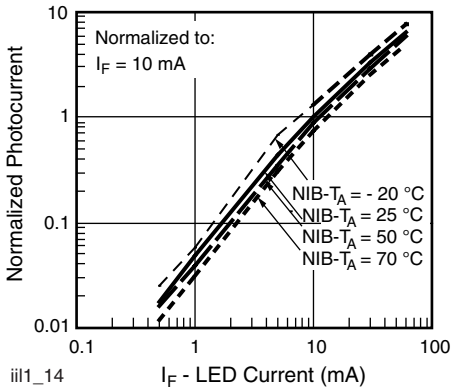

Fig. 14 - Normalized Photocurrent vs. I_F and Temperature

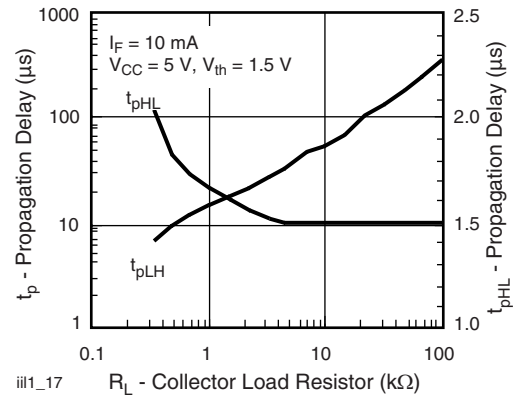

Fig. 17 - Propagation Delay vs. Collector Load Resistor

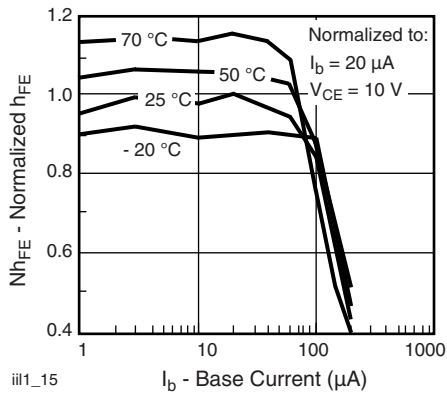
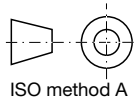
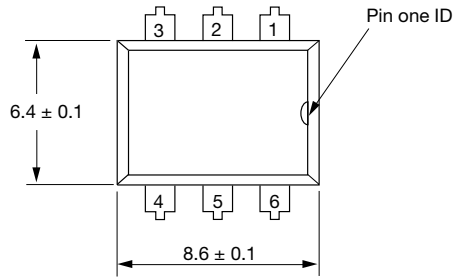
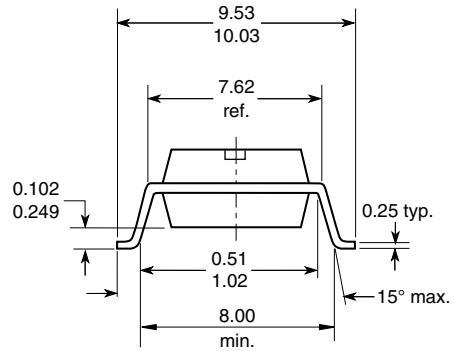

Fig. 15 - Normalized Non-Saturated h_{FE} vs. Base Current and Temperature

PACKAGE DIMENSIONS in millimeters



Option 9





Disclaimer

ALL PRODUCT, PRODUCT SPECIFICATIONS AND DATA ARE SUBJECT TO CHANGE WITHOUT NOTICE TO IMPROVE RELIABILITY, FUNCTION OR DESIGN OR OTHERWISE.

Vishay Intertechnology, Inc., its affiliates, agents, and employees, and all persons acting on its or their behalf (collectively, "Vishay"), disclaim any and all liability for any errors, inaccuracies or incompleteness contained in any datasheet or in any other disclosure relating to any product.

Vishay makes no warranty, representation or guarantee regarding the suitability of the products for any particular purpose or the continuing production of any product. To the maximum extent permitted by applicable law, Vishay disclaims (i) any and all liability arising out of the application or use of any product, (ii) any and all liability, including without limitation special, consequential or incidental damages, and (iii) any and all implied warranties, including warranties of fitness for particular purpose, non-infringement and merchantability.

Statements regarding the suitability of products for certain types of applications are based on Vishay's knowledge of typical requirements that are often placed on Vishay products in generic applications. Such statements are not binding statements about the suitability of products for a particular application. It is the customer's responsibility to validate that a particular product with the properties described in the product specification is suitable for use in a particular application. Parameters provided in datasheets and / or specifications may vary in different applications and performance may vary over time. All operating parameters, including typical parameters, must be validated for each customer application by the customer's technical experts. Product specifications do not expand or otherwise modify Vishay's terms and conditions of purchase, including but not limited to the warranty expressed therein.

Hyperlinks included in this datasheet may direct users to third-party websites. These links are provided as a convenience and for informational purposes only. Inclusion of these hyperlinks does not constitute an endorsement or an approval by Vishay of any of the products, services or opinions of the corporation, organization or individual associated with the third-party website. Vishay disclaims any and all liability and bears no responsibility for the accuracy, legality or content of the third-party website or for that of subsequent links.

Except as expressly indicated in writing, Vishay products are not designed for use in medical, life-saving, or life-sustaining applications or for any other application in which the failure of the Vishay product could result in personal injury or death. Customers using or selling Vishay products not expressly indicated for use in such applications do so at their own risk. Please contact authorized Vishay personnel to obtain written terms and conditions regarding products designed for such applications.

No license, express or implied, by estoppel or otherwise, to any intellectual property rights is granted by this document or by any conduct of Vishay. Product names and markings noted herein may be trademarks of their respective owners.