

INTRODUCTION:

Adam Tech DJ Series Circular DIN Jacks continue to be a popular interface for many applications. They are especially suitable for applications that require reliable transfer of low level signals. Available in a wide selection of positions they feature a choice of an all plastic body or a plastic body with metal face shield. Mounting selections include Right Angle or Vertical PCB mount and Panel Mount with or without mounting flange. Adam Tech DJ series jacks features an exclusive high reliability contact design which utilizes a dual wipe, extended fork contact. The jacks overall contact area is increased primarily in the mating area which helps maintain a constant contact pressure for superior electrical performance.

FEATURES:

Wide range of styles
Offered in 3 thru 13 positions
Standard and shielded versions available
Excellent for Low Level signal applications

MATING PLUGS:

All industry standard circular DIN plugs.

SPECIFICATIONS:

Material:

Standard insulator: PBT glass filled, rated UL94V-0
Optional Hi-Temp insulator: Nylon 6T, rated UL94V-0
Insulator Color: Black
Contacts: Brass
Shield: Copper Alloy, Bright Nickel plated

Contact Plating:

Tin over Copper underplate overall

Electrical:

Operating voltage: 20V DC max.
Current rating: 2 Amps max
Contact resistance: 20 mΩ max. initial
Insulation resistance: 500 MΩ min.
Dielectric withstanding voltage: 1000V AC for 1 minute

Mechanical:

Insertion force: 15 lb max.
Withdrawal force: 0.8 lb min
Mating durability: 5000 cycles min.

Temperature Rating:

Operating temperature: -55°C to +85°C
Soldering process temperature:
Standard insulator: 235°C
Hi-Temp insulator: 260°C

PACKAGING:

Anti-ESD plastic trays

APPROVALS AND CERTIFICATIONS:

UL Recognized & CSA Certified, File no. E224053

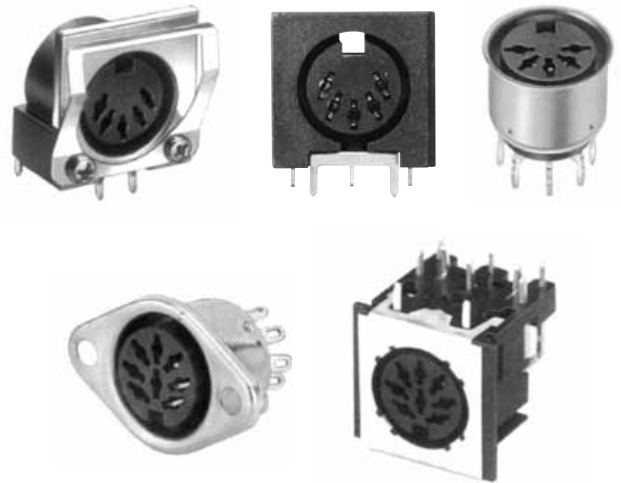

ORDERING INFORMATION RIGHT ANGLE PC BOARD MOUNT

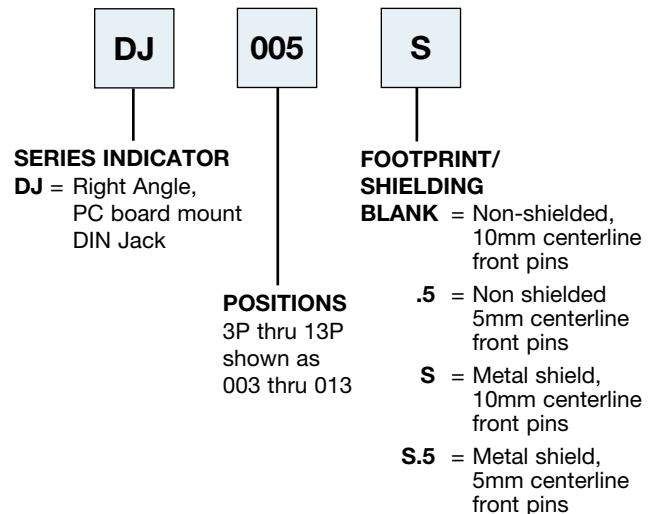

STRAIGHT PC BOARD MOUNT AND PANEL MOUNT VERSIONS

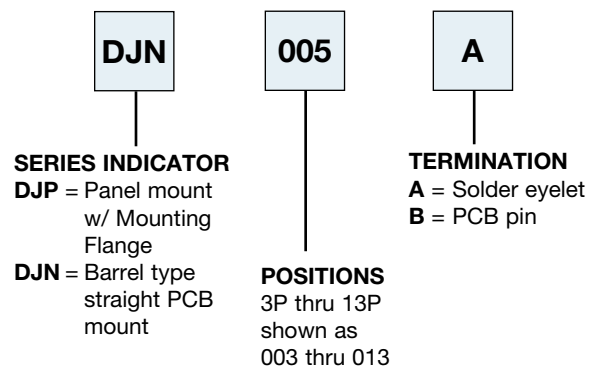

DIN JACK SHIELDED 5 POSITION

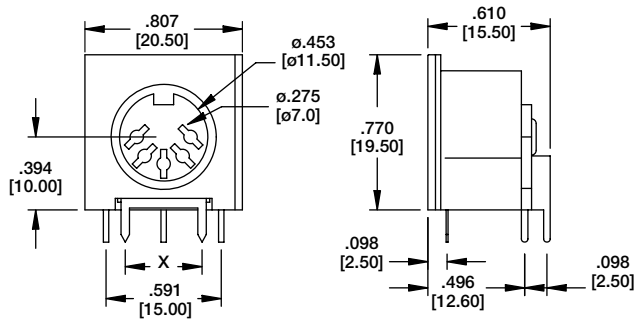

X = PITCH $.197$ [5.00] OR $.394$ [10.00]

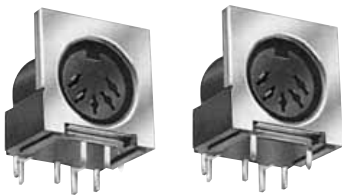

DJ-005-S.5

DJ-005-S

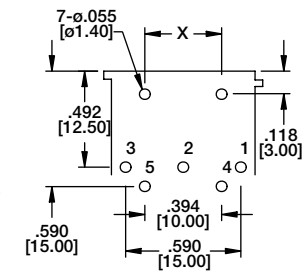

DIN JACK NON-SHIELDED 5 POSITION

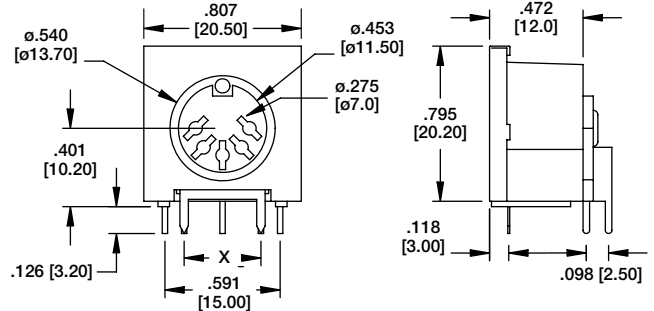

X = PITCH $.197$ [5.00] OR $.394$ [10.00]

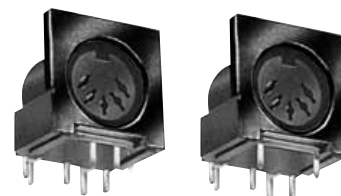

DJ-005-.5

DJ-005

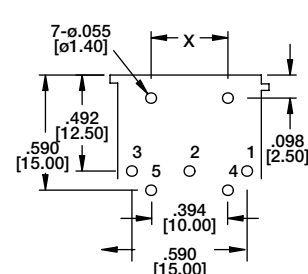

DIN JACKS NON-SHIELDED, POSITIONS: 3P, 4P, 6P, 7P, 8P

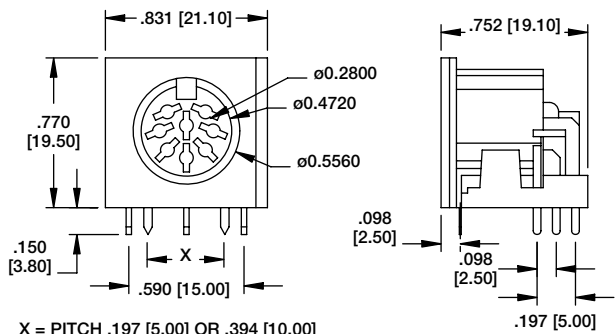

X = PITCH $.197$ [5.00] OR $.394$ [10.00]



DJ-008

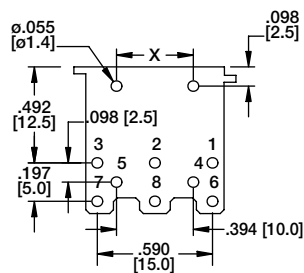

Recommended PCB Layout

DIN JACK SHIELDED, POSITIONS: 3P, 4P, 6P, 7P, 8P

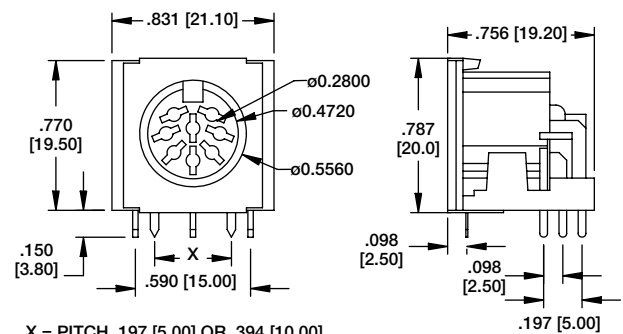

X = PITCH $.197$ [5.00] OR $.394$ [10.00]



DJ-008-S

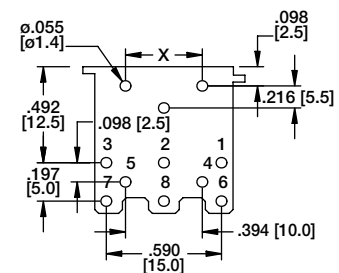

Recommended PCB Layout

MATING FACE CONFIGURATIONS

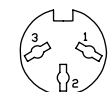

3 Position

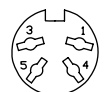

4 Position



5 Position











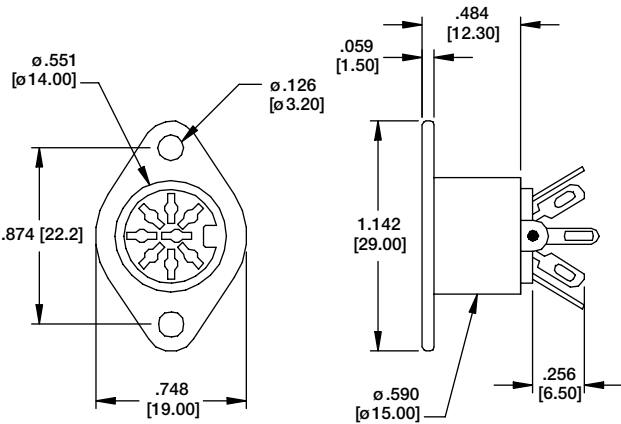

6 Position

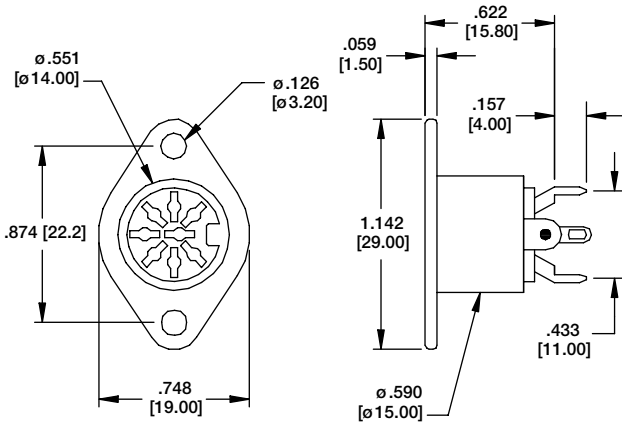

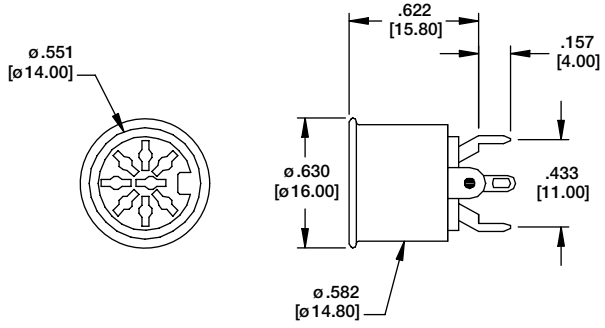
7 Position

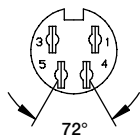
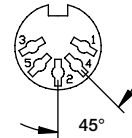
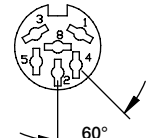
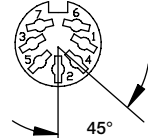
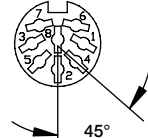

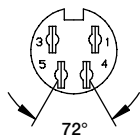
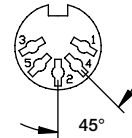
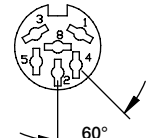
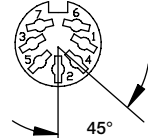
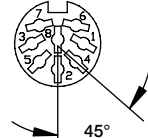
8 Position

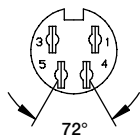
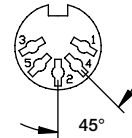
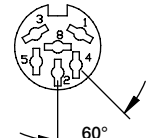
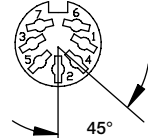
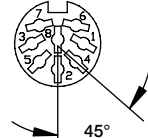
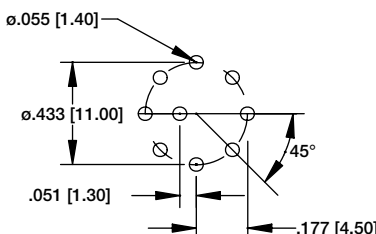
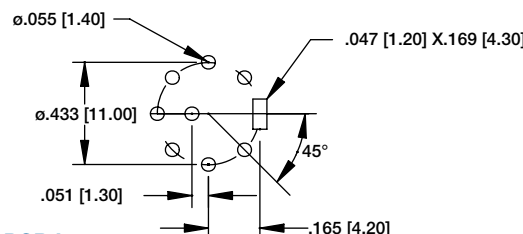
<p>DJP SERIES PANEL MOUNT DIN JACK WITH SOLDER EYELETS</p>  <p>DJP-008-A</p>  <p>Dimensions: $\phi .551$ [$\phi 14.00$], $\phi .126$ [$\phi 3.20$], $.059$ [1.50], $.484$ [12.30], $.874$ [22.2], 1.142 [29.00], $\phi .590$ [$\phi 15.00$], $.256$ [6.50], $.748$ [19.00].</p>	<p>DJP SERIES PCB MOUNT DIN JACK</p>  <p>DJP-008-B</p>  <p>Dimensions: $\phi .551$ [$\phi 14.00$], $\phi .126$ [$\phi 3.20$], $.059$ [1.50], $.622$ [15.80], $.874$ [22.2], 1.142 [29.00], $\phi .590$ [$\phi 15.00$], $.433$ [11.00], $.157$ [4.00], $.748$ [19.00].</p>							
<p>DJN SERIES PCB MOUNT DIN JACK</p>  <p>DJN-005-B</p>  <p>Dimensions: $\phi .551$ [$\phi 14.00$], $\phi .630$ [$\phi 16.00$], $.622$ [15.80], $.157$ [4.00], $\phi .582$ [$\phi 14.80$], $.433$ [11.00].</p>	<table border="1"> <tr> <td data-bbox="831 949 1188 1186"> <p>3 Position</p>  </td> <td data-bbox="1188 949 1555 1186"> <p>4 Position</p>  <p>72°</p> </td> </tr> <tr> <td data-bbox="831 1186 1188 1438"> <p>5 Position</p>  <p>45°</p> </td> <td data-bbox="1188 1186 1555 1438"> <p>6 Position</p>  <p>60°</p> </td> </tr> <tr> <td data-bbox="831 1438 1188 1648"> <p>7 Position</p>  <p>45°</p> </td> <td data-bbox="1188 1438 1555 1648"> <p>8 Position</p>  <p>45°</p> </td> </tr> </table>		<p>3 Position</p> 	<p>4 Position</p>  <p>72°</p>	<p>5 Position</p>  <p>45°</p>	<p>6 Position</p>  <p>60°</p>	<p>7 Position</p>  <p>45°</p>	<p>8 Position</p>  <p>45°</p>
<p>3 Position</p> 	<p>4 Position</p>  <p>72°</p>							
<p>5 Position</p>  <p>45°</p>	<p>6 Position</p>  <p>60°</p>							
<p>7 Position</p>  <p>45°</p>	<p>8 Position</p>  <p>45°</p>							
<p>DJN Series (Type A)</p>  <p>Dimensions: $\phi .055$ [1.40], $\phi .433$ [11.00], $.051$ [1.30], $.433$ [11.00], $.177$ [4.50], 45°.</p> <p>DJP Series</p>  <p>Dimensions: $\phi .055$ [1.40], $\phi .433$ [11.00], $.047$ [1.20] X $.169$ [4.30], $.051$ [1.30], $.165$ [4.20], 45°.</p> <p>Recommended PCB Layouts</p>								