

Package: SOF-26



Product Description

RFMD's SZP-3026Z is a high-linearity, single-stage, class AB Heterojunction Bipolar Transistor (HBT) power amplifier. It is designed with InGaP-on-GaAs device technology and fabricated with MOCVD for an ideal combination of low cost and high reliability. This product is specifically designed for use as a driver or final stage power amp for 802.16 equipment in the 3.0GHz to 3.8GHz bands. It is pre-matched on both ports to simplify external application circuit design. It features an input power detector, on/off power control, ESD protection, excellent overall robustness, and a hand reworkable and thermally enhanced surface-mount SOF-26 package.

Optimum Technology Matching® Applied

- GaAs HBT
- GaAs MESFET
- InGaP HBT
- SiGe BiCMOS
- Si BiCMOS
- SiGe HBT
- GaAs pHEMT
- Si CMOS
- Si BJT
- GaN HEMT
- InP HBT
- RF MEMS
- LDMOS

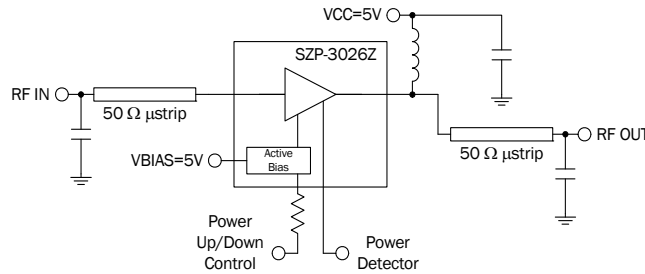

Features

- $P_{1dB} = 33.6\text{dBm}$ at 5V
- 802.11g 54 Mb/s Class AB Performance
- $P_{OUT} = 26\text{dBm}$ at 2.5% EVM, $V_{CC} = 5\text{V}$, 570mA
- $P_{OUT} = 27\text{dBm}$ at 2.5% EVM, $V_{CC} = 6\text{V}$, 513mA
- On-Chip Output Power Detector
- Input Prematched to $\sim 5\Omega$
- Proprietary Low Thermal Resistance Package
- Hand Solderable and Easy Rework
- Power Up/Down Control $< 1\mu\text{s}$

Applications

- 802.16 WiMAX Driver or Output Stage
- WLL

Parameter	Specification			Unit	Condition
	Min.	Typ.	Max.		
Frequency of Operation	3000		3800	MHz	
Output Power at 1dB Compression		33.2		dBm	3.5GHz
Small Signal Gain	10.5	12.0		dB	3.5GHz
EVM (802.11g 54 Mb/s) at $P_{OUT} = 26\text{dBm}$		2.5		%	3.5GHz
Third Order Suppression ($P_{OUT} = 23\text{dBm}$ per tone)		-43	-40	dBc	3.5GHz
Noise Figure		5.1		dB	3.5GHz
Worst Case Input Return Loss	14	18		dB	3.4GHz to 3.6GHz
Worst Case Output Return Loss	7	10		dB	3.4GHz to 3.6GHz
Output Voltage Range for $P_{OUT} = 10\text{dBm}$ to 33dBm		0.9 to 2.2		V	
Quiescent Current ($V_{CC} = 5\text{V}$)	347	385	424	mA	
Power Up Control Current ($V_{PC} = 5\text{V}$)		2.3		mA	
V_{CC} Leakage Current ($V_{CC} = 5\text{V}$, $V_{PC} = 0\text{V}$)			100	μA	
Thermal Resistance		12		$^{\circ}\text{C}/\text{W}$	Junction to lead

Test Conditions: $Z_0 = 50\Omega$, $V_{CC} = 5\text{V}$, $I_Q = 385\text{mA}$, $T_{BP} = 30^{\circ}\text{C}$

Absolute Maximum Ratings

Parameter	Rating	Unit
VC1 Collector Bias Current (I_{VC1})	1500	mA
**Device Voltage (V_D)	7.0	V
Power Dissipation	6	W
Operating Lead Temperature (T_L)	-40 to +85	°C
*Max RF Output Power for 50Ω continuous long term operation	30	dBm
Max Modulated (***)OFDM RF Input Power for 50Ω Output Load, $V_{CC}=+6V$	27	dBm
Max Modulated (***)OFDM RF Input Power for 10:1 VSWR Output Load, $V_{CC}=+6V$	20	dBm
Storage Temperature Range	-40 to +150	°C
Operating Junction Temp (T_J)	+150	°C
ESD Rating - Human Body Model	1000	V

*With specified application circuit
 **No RF Drive
 ***Modulation schemes include 802.11a/g, 802.16

Operation of this device beyond any one of these limits may cause permanent damage. For reliable continuous operation, the device voltage and current must not exceed the maximum operating values specified in the table on page one.

Bias conditions should also satisfy the following expression:
 $I_D V_D < (T_J - T_L) / R_{TH, j-H}$



Caution! ESD sensitive device.

Exceeding any one or a combination of the Absolute Maximum Rating conditions may cause permanent damage to the device. Extended application of Absolute Maximum Rating conditions to the device may reduce device reliability. Specified typical performance or functional operation of the device under Absolute Maximum Rating conditions is not implied.

RoHS status based on EU Directive 2002/95/EC (at time of this document revision).

The information in this publication is believed to be accurate and reliable. However, no responsibility is assumed by RF Micro Devices, Inc. ("RFMD") for its use, nor for any infringement of patents, or other rights of third parties, resulting from its use. No license is granted by implication or otherwise under any patent or patent rights of RFMD. RFMD reserves the right to change component circuitry, recommended application circuitry and specifications at any time without prior notice.

Typical 5V Performance with Appropriate App Circuit ($V_{CC}=5V$, $I_{CQ}=385mA$, *802.11g 54Mb/s)

Parameter	Unit	3.0 GHz	3.3 GHz	3.4 GHz	3.5 GHz	3.6 GHz	3.7 GHz	3.8 GHz
Gain @ $P_{OUT}=26dBm$	dB	12.4	12.4	12.4	12.2	12.0	11.5	11.0
P1dB	dBm	33.9	33.9	33.6	33.2	32.9	32.6	32.1
P_{OUT} @ 2.5% EVM*	dBm	26.5	26.5	26.5	26.0	25.5	25.5	25.0
Current @ P_{OUT} 2.5% EVM*	mA	590	580	580	570	560	560	550
Input Return Loss	dB	21.8	21.8	20.6	19.6	18.3	15.9	15.9
Output Return Loss	dB	9.0	9.0	10.0	11.2	11.7	10.3	10.3

Measured 3.4GHz to 3.6GHz, 5V Application Circuit Data ($V_{CC}=V_{PC}=5.0V$, $I_Q=385mA$, $T=25^\circ C$)

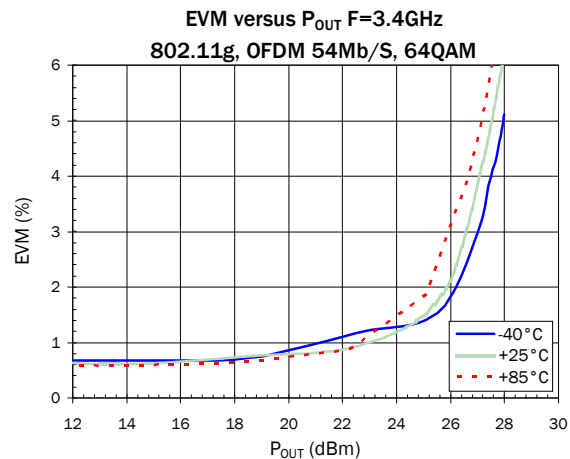
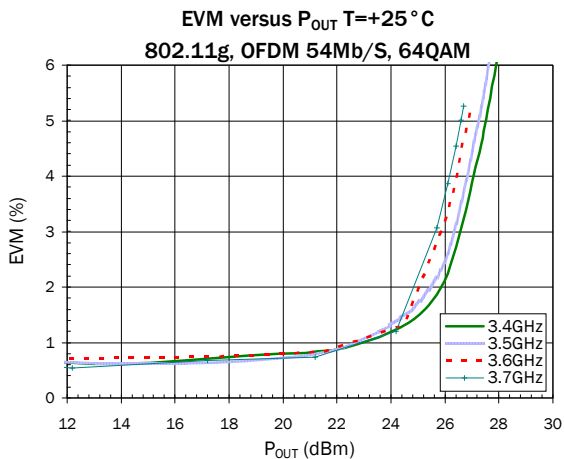

Measured 3.4GHz to 3.6GHz, 5V Application Circuit Data ($V_{CC}=V_{PC}=5.0V$, $I_Q=385mA$, $T=25^\circ C$)

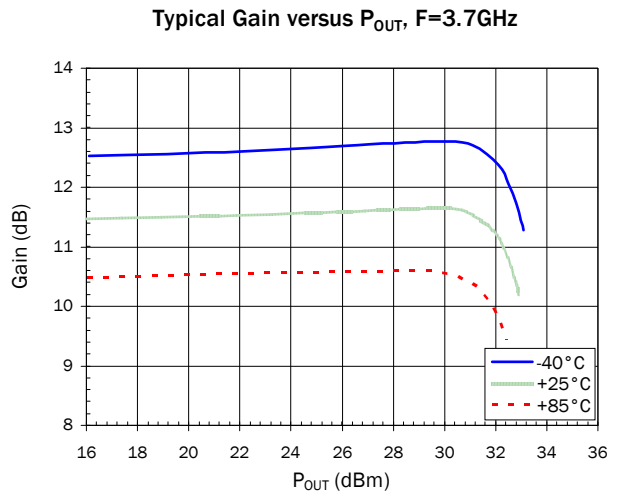
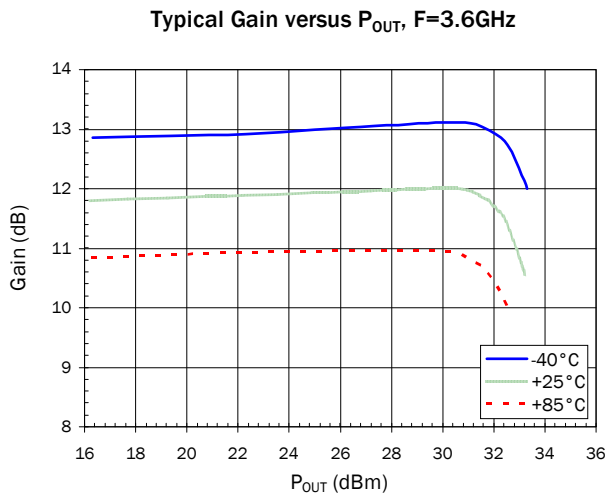
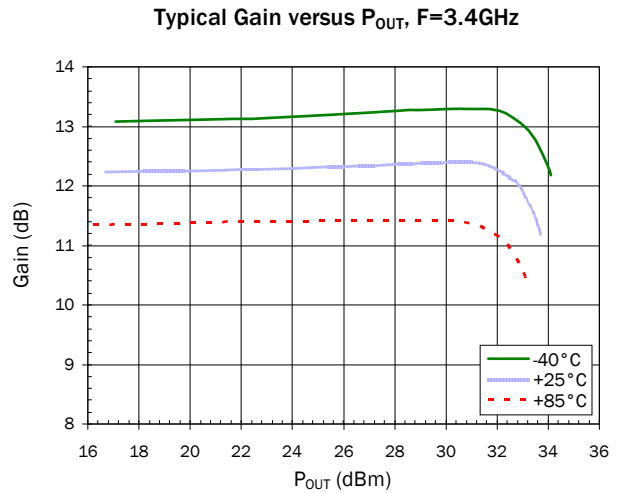
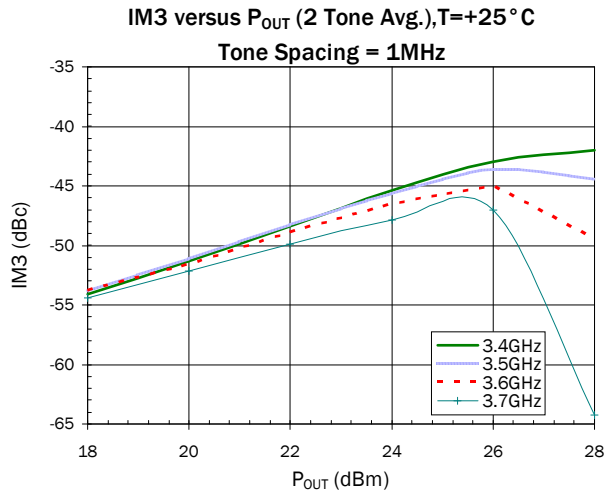
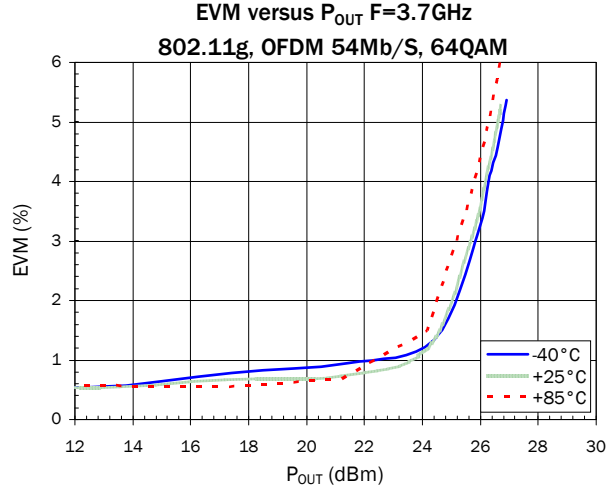
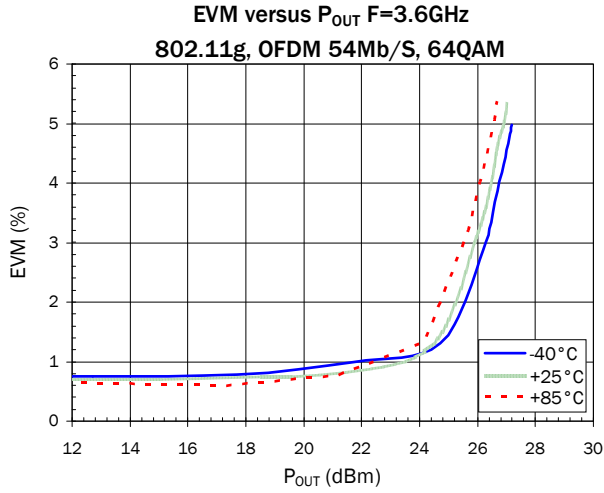

Measured 3.4GHz to 3.6GHz, 5V Application Circuit Data ($V_{CC}=V_{PC}=5.0V$, $I_Q=385mA$, $T=25^\circ C$)

Narrowband S11 - Input Return Loss

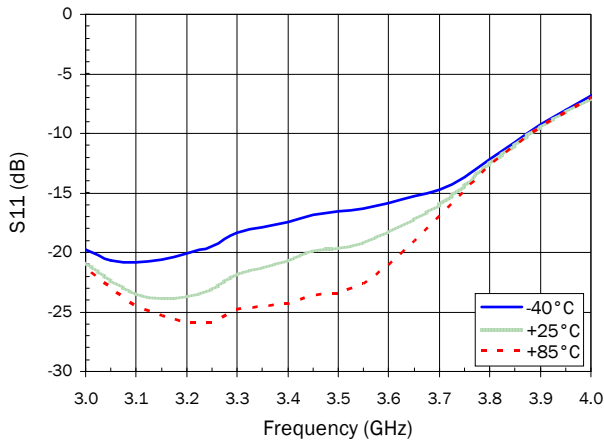

Narrowband S21 - Forward Gain

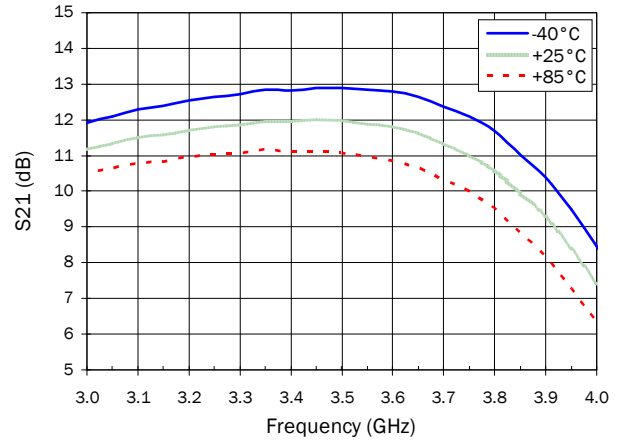

Narrowband S12 - Reverse Isolation

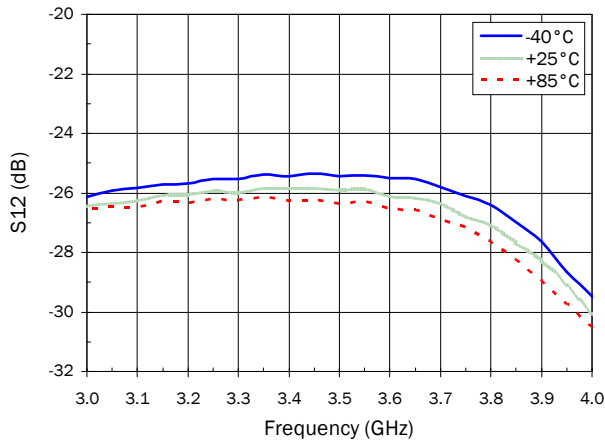

Narrowband S22 - Output Return Loss

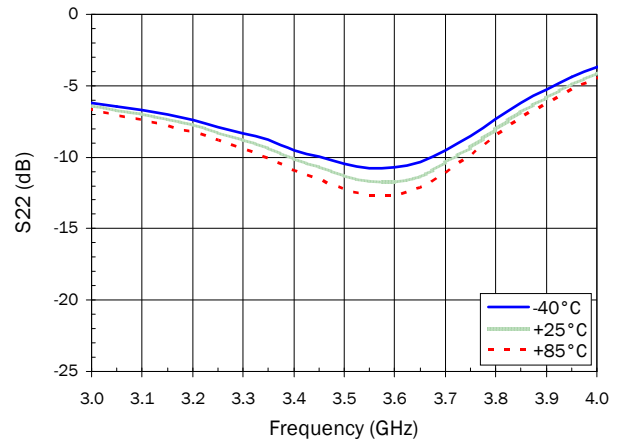

DC Supply Current versus P_{OUT} , $T=+25^\circ C$

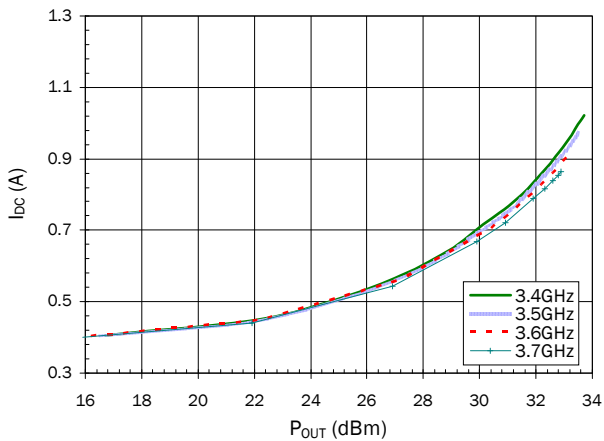

DC Supply Current versus P_{OUT} , $F=3.5GHz$

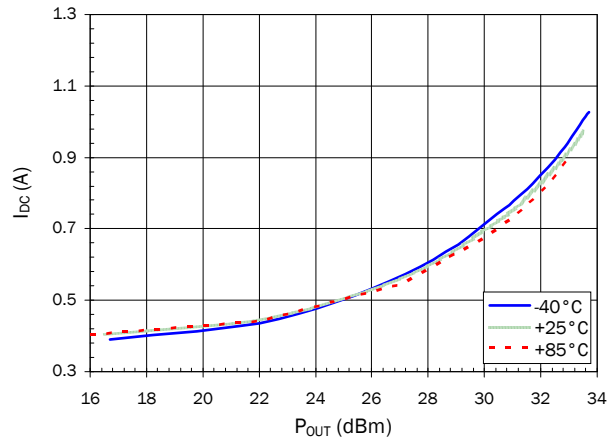

Measured 3.4GHz to 3.6GHz, 5V Application Circuit Data ($V_{CC}=V_{PC}=5.0V$, $I_Q=385mA$, $T=25^\circ C$)

Noise Figure versus Frequency, O.T.

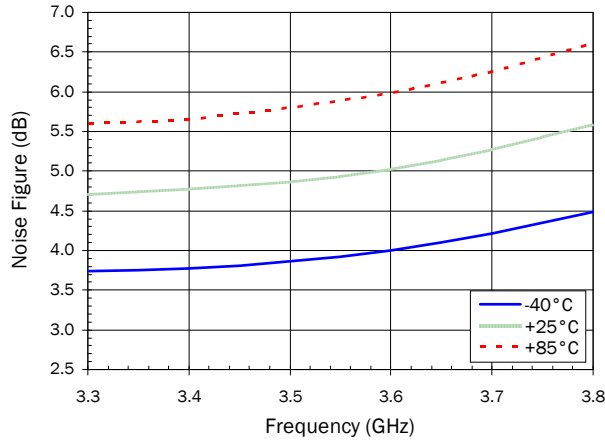

RF Power Detector (V_{DET}) versus P_{OUT} , F=3.4GHz

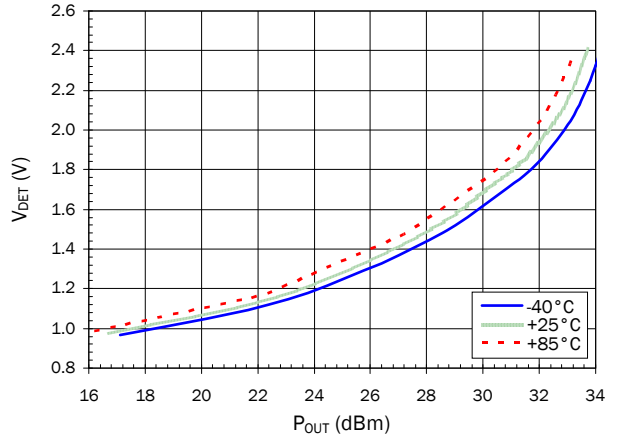

RF Power Detector (V_{DET}) versus P_{OUT} , F=3.6GHz

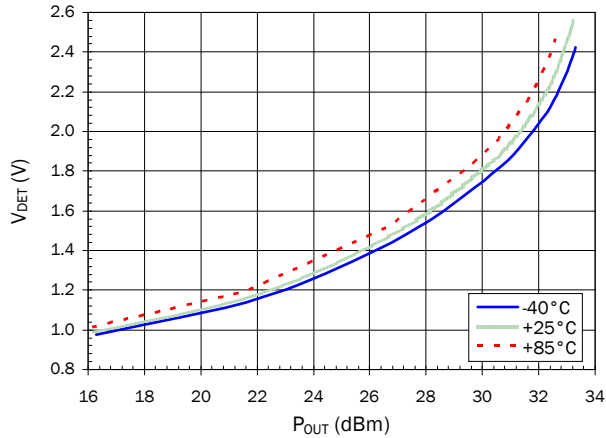

RF Power Detector (V_{DET}) versus P_{OUT} , F=3.7GHz

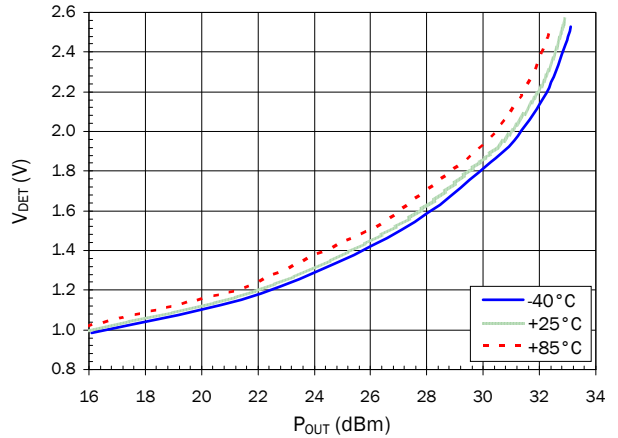

Measured 3.4GHz to 3.6GHz, 5V Application Circuit Data ($V_{CC}=V_{PC}=5.0V$, $I_Q=385mA$, $T=25^\circ C$)

Broadband S11 - Input Return Loss

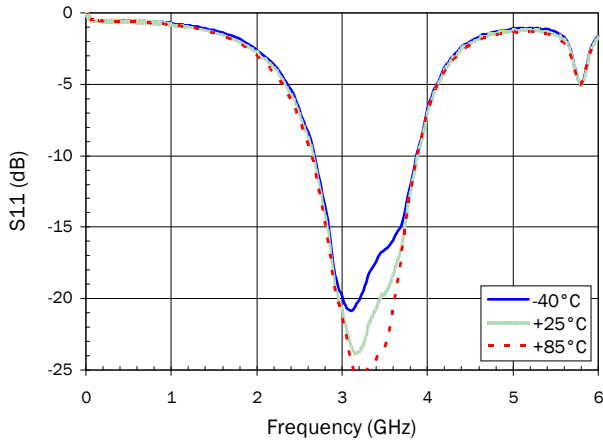

Broadband S21 - Forward Gain

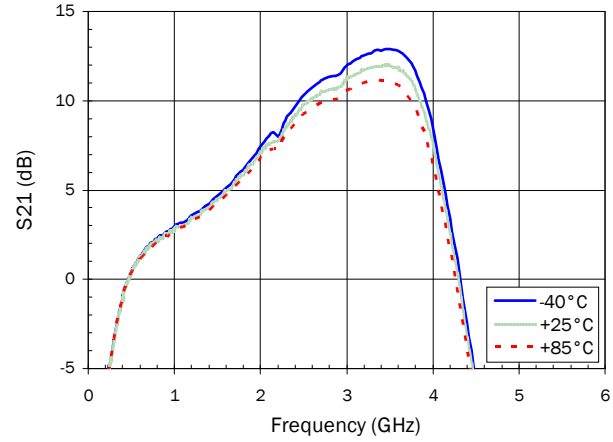

Broadband S12 - Reverse Isolation

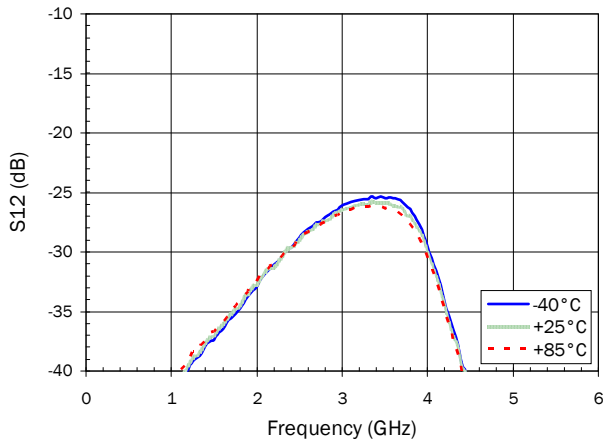

Broadband S22 - Output Return Loss

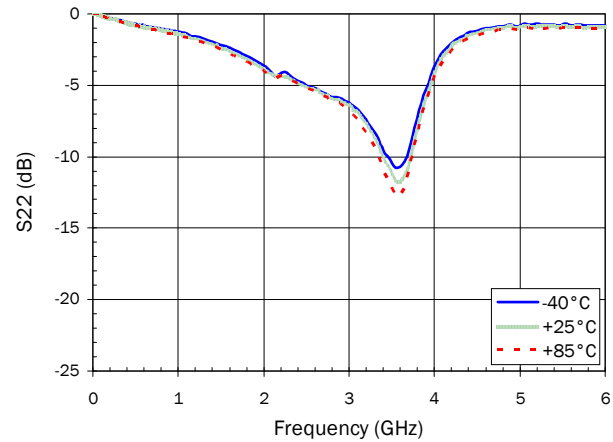

Pin	Function	Description
1	VBIAS	This is the supply voltage for the active bias circuit.
2	RFIN	This is the RF input pin and has a DC voltage present. An external DC block is required.
3	VPC	Power up/down control pin. The voltage on this pin should never exceed the voltage on pin 1 by more than 0.5V unless the supply current from pin 3 is limited < 10mA.
4	VDET	This is the output port for the power detector. It samples the power at the input of the amplifier.
5	RFOUT/VCC	This is the RF output pin and DC connection to the collector.
6	NC	This pin is not connected internal to the package. Buss it to pin 5 as shown on the app circuit to achieve the specified performance.
GND	GND	These pins are DC connected to the backside paddle. They provide good thermal connection to the backside paddle for hand soldering and rework. Many thermal and electrical GND vias are recommended as shown in the landing pattern.

Simplified Device Schematic

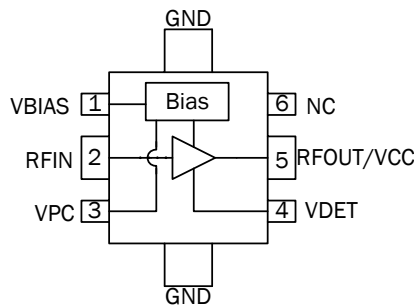

Application Schematic

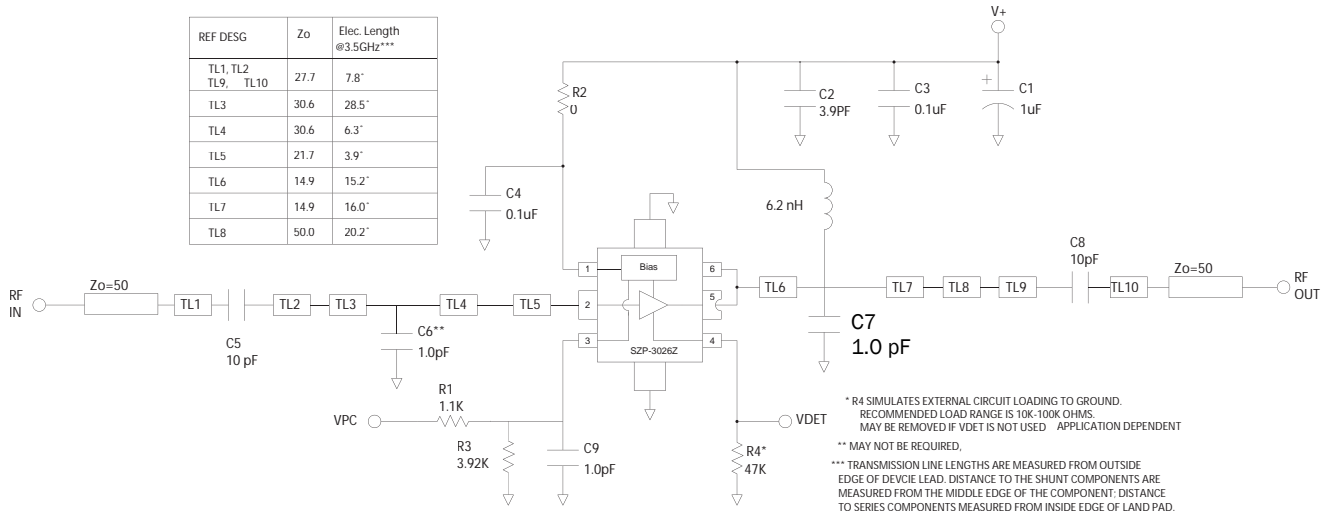

Evaluation Board Layout

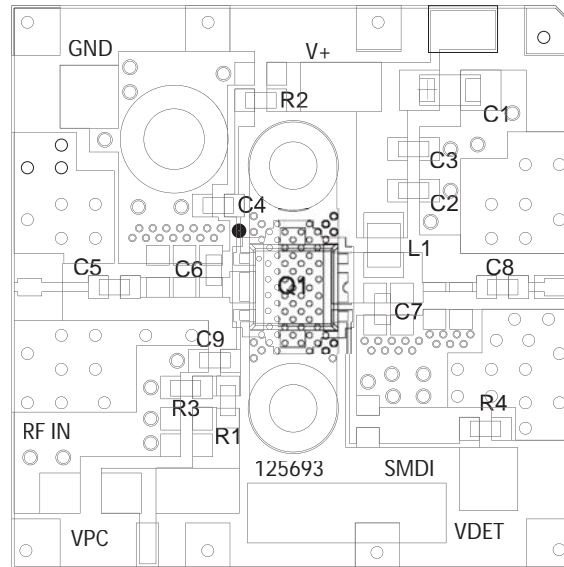

** Replace resistors R1 and R3 for 6V operation

PCB Notes: Do not use less than the recommended number of via holes under the device ground paddle. RF layers thicker than 0.020 inches (0.5mm) not recommended.

Bill of Materials

DESG	Description	Notes
Q1	SZP-3026Z	S0F-26
R1**	1.1K Ω , 0603 1%	0402 may be used.
R2	0 Ω , 0603	0402 may be used.
R3**	3.92K Ω , 0603 1%	0402 may be used.
R4	47K Ω , 0603	0402 may be used.
C1	1uF 16V MLCC CAP	Tantulum ok for EVM performance. Use MLCC type for best IM3 levels.
C2	3.9pF CAP, 0603	NPO ROHM MCH185A3R9DK or equiv.
C3, 4	0.1uF CAP, 0603	X7R 0402 ok, ROHM MCH182CN104K or equiv.
C5, 8	10pF CAP, 0603	NPO, low ESR ATC 600S100JW250X or equiv.
C6, 7, 9	1.0pF CAP, 0603	NPO, 0402 ok ROHM MCH185A1R0DK or equiv.
L1	6.2nH IND, 0805	Coilcraft 0805 HQ-6N2XJBB

App circuit VCC=VPC=6V resistor values

R1**	1.37k Ω , 0603 1%	0402 may be used.
R3**	2.21k Ω , 0603 1%	0402 may be used.

Typical Performance with 6V Application Circuit

$V_{CC}=6V$, $I_{CQ}=326mA$, *802.11g 54Mb/s 64QAM

Parameter	Unit	3.0 GHz	3.3 GHz	3.4 GHz	3.5 GHz	3.6 GHz	3.7 GHz	3.8 GHz
Gain at $P_{OUT}=26dBm$	dB	11.5	11.5	11.3	11.3	11.3	11.4	11.2
P1dB	dBm	35.2	35.2	35.2	35.2	35.0	34.5	33.9
P_{OUT} at 2.5% EVM*	dBm	27.0	27.0	27.0	27.1	27.0	26.9	26.2
Current at P_{OUT} 2.5% EVM*	mA	529	529	523	513	501	487	467
Input Return Loss	dB	15.9	15.9	14.2	13.9	14.5	17.3	21.7
Output Return Loss	dB	8.7	8.7	10.3	12.0	13.5	12.8	10.2

Measured 3.4GHz to 3.6GHz, 6V Application Circuit Data ($V_{CC}=V_{PC}=6.0V$, $I_Q=326mA$, $T=25^\circ C$)

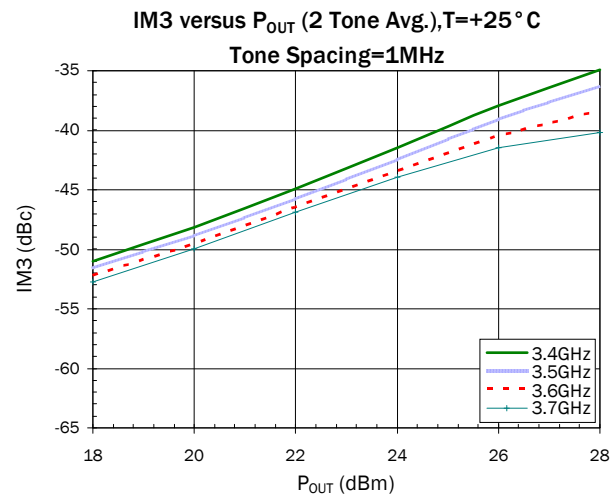
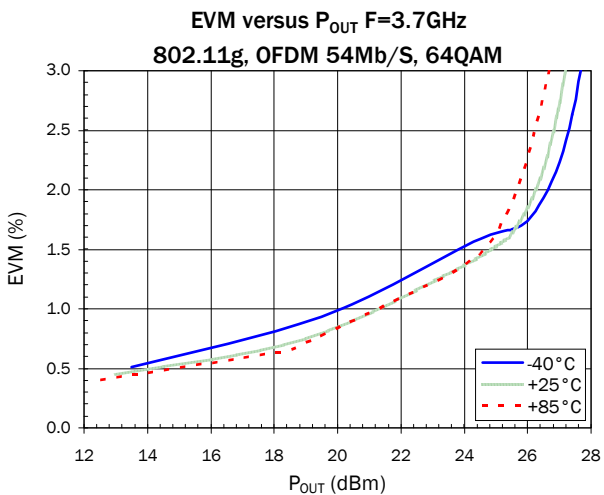
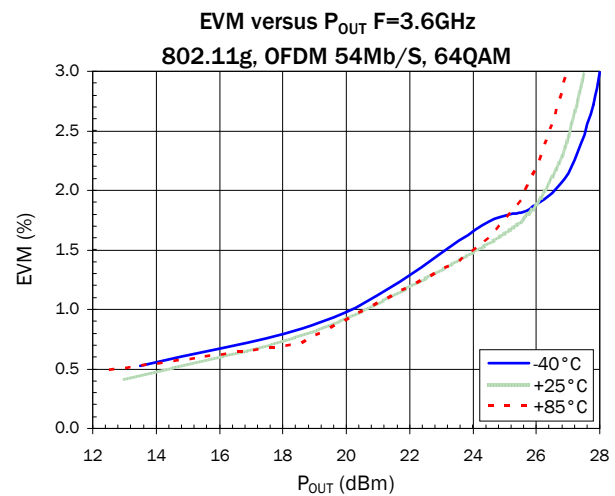
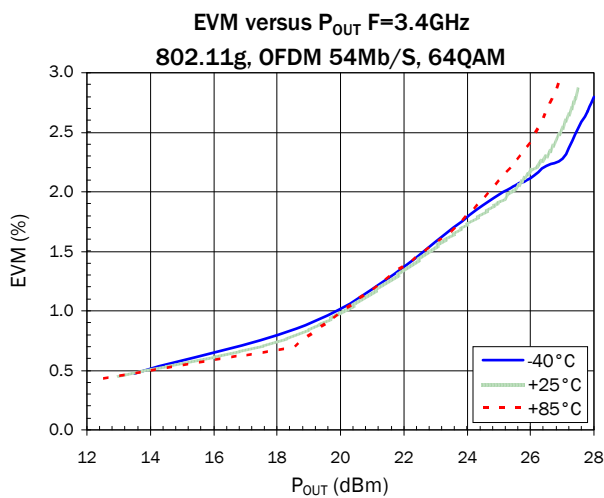

Measured 3.4GHz to 3.6GHz, 6V Application Circuit Data ($V_{CC}=V_{PC}=6.0V$, $I_Q=326mA$, $T=25^\circ C$)

Typical Gain versus P_{OUT} , F=3.4GHz

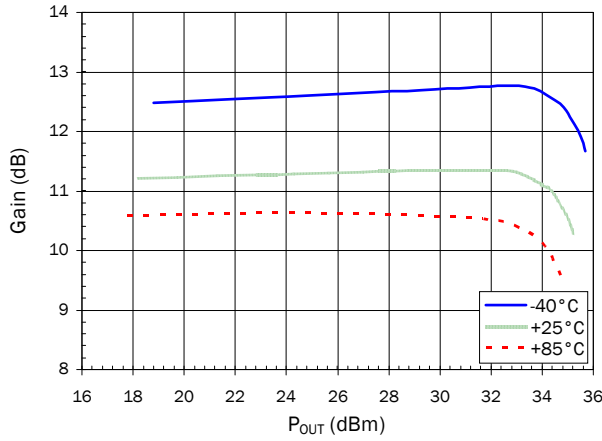

Typical Gain versus P_{OUT} , F=3.6GHz

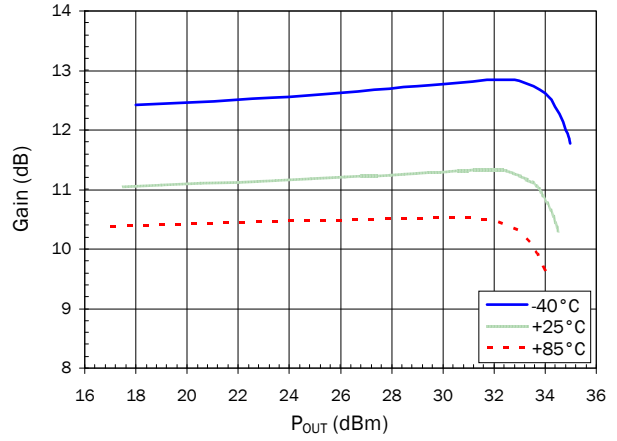

DC Supply Current versus P_{OUT} , F=3.5GHz

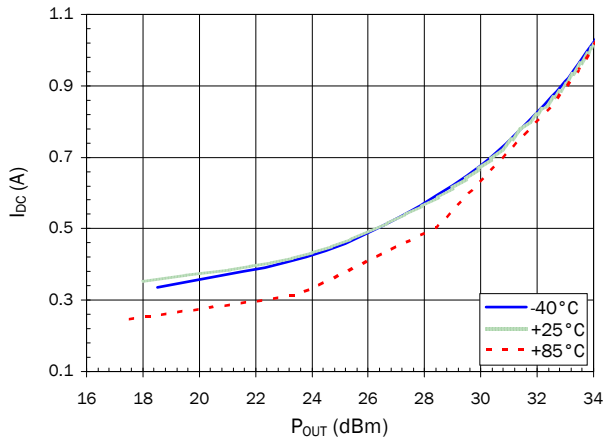

RF Power Detector (V_{DET}) versus P_{OUT} , F=3.4GHz

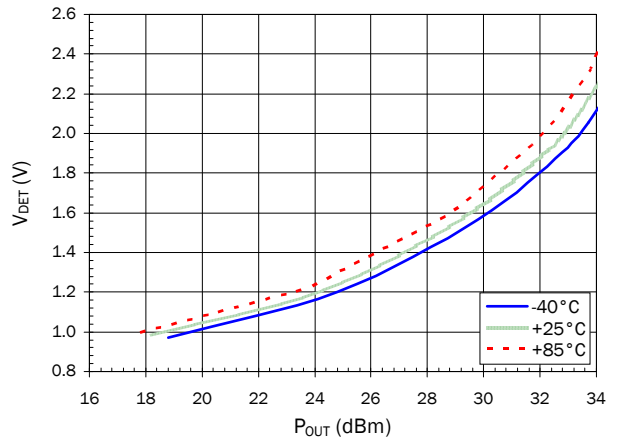

RF Power Detector (V_{DET}) versus P_{OUT} , F=3.6GHz

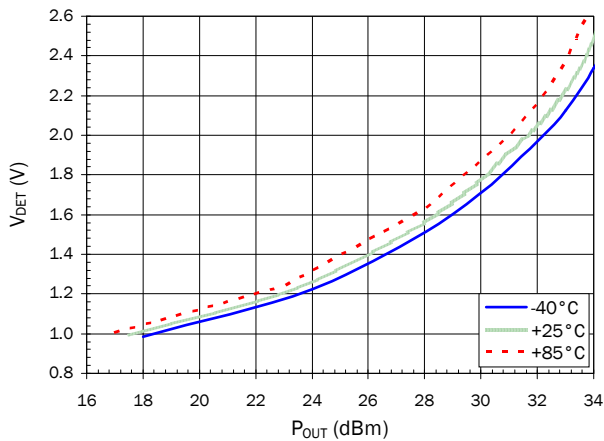

Package Drawing

Dimensions in millimeters (inches)

Refer to drawing posted at www.rfmd.com for tolerances.

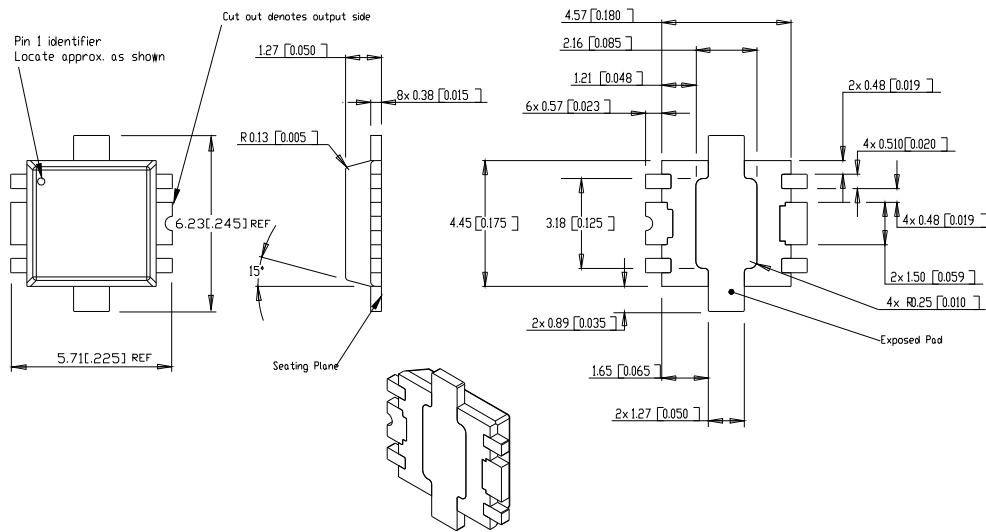

Part Symbolization

The part will be symbolized with a "SZP-3026Z" to designate it as a RoHS green compliant product. Marking designator will be on the top surface of the package.

Recommended Metal Land Pattern

Dimensions in millimeters (inches)

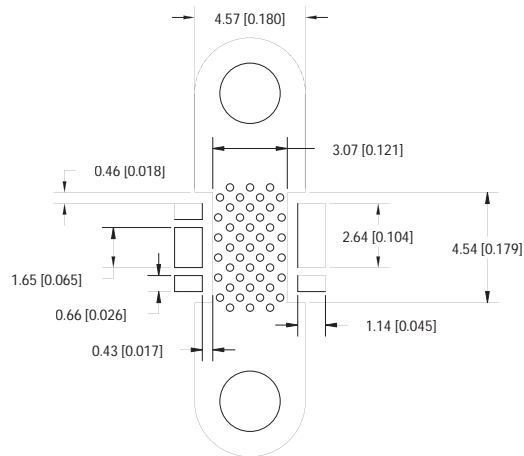

Ordering Information

Ordering Code	Description
SZP3026ZSQ	Standard 25 piece bag
SZP3026ZSR	Standard 100 piece reel
SZP3026Z	Standard 1000 piece reel
SZP3026Z-EVB1	Evaluation Board