



# BUF-01

## PRECISION BUFFER/VOLTAGE FOLLOWER WITH OVERVOLTAGE PROTECTION

### FEATURES

- Output Error Fully Specified ..... 250 $\mu$ V Maximum
- Low Input Offset Voltage ..... 60 $\mu$ V Typical
- Pin Compatible with LM110
- Drives 10k $\Omega$  Load to  $\pm$ 10V
- Low Voltage Gain Error ..... 0.001%
- Excellent Power Supply Rejection Ratio ..... 106dB Typical
- Low Output Impedance ..... 0.03 $\Omega$  Typical
- Low Input Noise Voltage ..... 0.8 $\mu$ V<sub>p-p</sub> Maximum

### GENERAL DESCRIPTION

The BUF-01 is the first precision voltage follower tested and guaranteed with a **Maximum Output Error** specification. **Maximum Output Error** includes errors introduced by offset

voltage, input bias current, gain, CMRR and output loading. This ensures that the **TOTAL** output error will not exceed the maximum under any combination of input or output.

Pin compatible with the LM110, the BUF-01 features low output impedance (0.03 $\Omega$  typical), high gain and excellent power supply rejection (106dB typical) with extremely low input voltage noise.

Fabricated with Precision Monolithics' exclusive Silicon-Nitride "Triple Passivation"™ Process, the BUF-01 utilizes on-chip zener-zap trimming to achieve very low offset voltage with excellent long-term stability. This eliminates the need for offset nulling in all but the most stringent applications.

### ORDERING INFORMATION†

T <sub>A</sub> = 25°C V <sub>OS</sub> MAX ( $\mu$ V)	HERMETIC PACKAGE		OPERATING TEMPERATURE RANGE
	TO-99 8-PIN	DIP 8-PIN	
100	BUF01AJ*	BUF01AZ*	MIL
100	BUF01EJ	BUF01EZ	COM
150	BUF01BJ*	BUF01BZ*	MIL
150	BUF01FJ	BUF01FZ	COM

\* Also available with MIL-STD-883B processing. To order add/883 as a suffix to the part number.

† All listed parts are available with 160 hour burn-in. See Ordering Information, Section 2.

### PIN CONNECTIONS

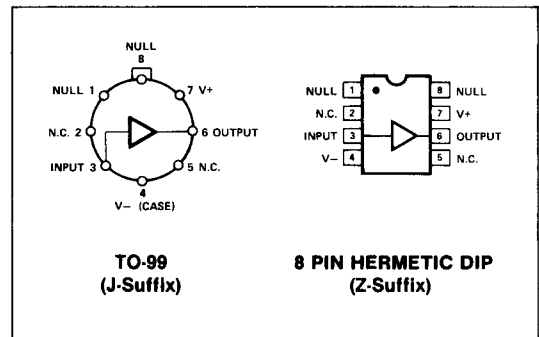

### SIMPLIFIED SCHEMATIC

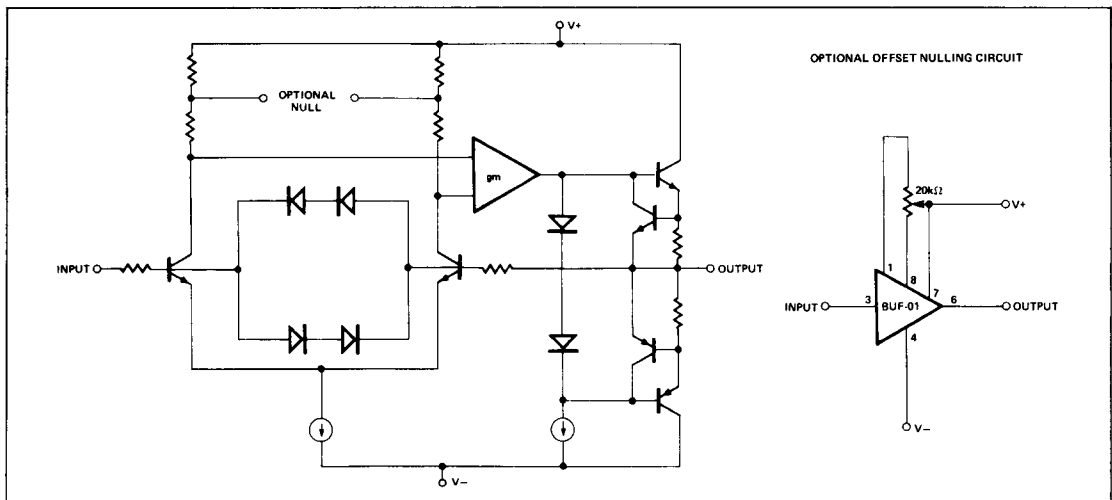

**ABSOLUTE MAXIMUM RATINGS** (Note 3)

Supply Voltage	±22V
Internal Power Dissipation (Note 1)	500mW
Input Voltage (Note 2)	±22V
Output Short Circuit Duration	Indefinite
Storage Temperature Range	-65°C to +150°C
Operating Temperature Range	
BUF-01A, BUF-01B	-55°C to +125°C
BUF-01E, BUF-01F	0°C to +70°C
DICE Junction Temperature (T <sub>J</sub> )	-65°C to +150°C
Lead Temperature Range (Soldering, 60 sec)	300°C

**NOTES:**

- See table for maximum ambient temperature rating and derating factor.
- For supply voltages less than ±22V, the absolute maximum input voltage is equal to the supply voltage.
- Absolute ratings apply to both DICE and packaged parts unless otherwise noted.

Package Type	Maximum Ambient Temperature Rating	Derate Above Maximum Ambient Temperature
TO-99(J)	80°C	7.1mW/°C
8 PIN HERMETIC DIP (Z)	75°C	6.7mW/°C

**ELECTRICAL CHARACTERISTICS** at V<sub>S</sub> = ±15V, T<sub>A</sub> = +25°C, unless otherwise noted.

PARAMETER	SYMBOL	CONDITIONS	BUF-01A BUF-01E			BUF-01B BUF-01F			UNITS
			MIN	TYP	MAX	MIN	TYP	MAX	
Maximum Output Error	OUT <sub>error</sub>	V <sub>IN</sub> = +10V, 0V, -10V R <sub>S</sub> = 0 to 20kΩ R <sub>L</sub> ≥ 10kΩ (in all combinations.)	—	0.1	0.25	—	0.2	0.5	mV
Input Offset Voltage	V <sub>OS</sub>	V <sub>IN</sub> = 0V, R <sub>S</sub> = 50Ω	—	60	100	—	80	150	μV
Input Current	I <sub>IN</sub>		—	±2.0	±7.0	—	±2.0	±7.0	nA
Input Resistance	R <sub>IN</sub>		—	10 <sup>11</sup>	—	—	10 <sup>11</sup>	—	Ω
Large-Signal Voltage Gain Error	A <sub>VE</sub>	R <sub>L</sub> ≥ 10kΩ, V <sub>O</sub> = ±10V	—	0.001	0.0025	—	0.001	0.005	%
Output Resistance	R <sub>O</sub>	V <sub>O</sub> = 0, I <sub>O</sub> = 0	—	0.03	—	—	0.03	—	Ω
Input Voltage Range	V <sub>IN</sub>		±12.0	±13.0	—	±12.0	±13.0	—	V
Output Current	I <sub>O</sub>	-5V ≤ V <sub>O</sub> ≤ +5V	—	±13	—	—	±13	—	mA
Power Supply Rejection Ratio	PSRR	±3V ≤ V <sub>S</sub> ≤ ±18V	—	5	20	—	7	32	μV/V
Small Signal Bandwidth	BW	(Note 1)	0.4	0.7	—	0.4	0.7	—	MHz
Input Noise Voltage	e <sub>n p-p</sub>	0.1Hz to 10Hz (Note 2)	—	0.5	0.8	—	0.5	0.8	μV <sub>p-p</sub>
Input Noise Current	i <sub>n p-p</sub>	0.1Hz to 10Hz (Note 2)	—	15	40	—	15	40	pA <sub>p-p</sub>
Slew Rate	SR	R <sub>L</sub> ≥ 10kΩ (Note 1)	0.1	0.2	—	0.1	0.2	—	V/μs
Power Consumption	P <sub>d</sub>	V <sub>S</sub> = ±15V, V <sub>O</sub> = 0	—	75	120	—	80	150	mW
		V <sub>S</sub> = ±3V, V <sub>O</sub> = 0	—	6	—	—	8	—	

**ELECTRICAL CHARACTERISTICS** at V<sub>S</sub> = ±15V, -55°C ≤ T<sub>A</sub> ≤ +125°C for BUF-01A and BUF-01B, 0°C ≤ T<sub>A</sub> ≤ +70°C for BUF-01E and BUF-01F, unless otherwise noted.

PARAMETER	SYMBOL	CONDITIONS	BUF-01A BUF-01E			BUF-01B BUF-01F			UNITS
			MIN	TYP	MAX	MIN	TYP	MAX	
Maximum Output Error	OUT <sub>error</sub>	V <sub>IN</sub> = +10V, 0V, -10V; R <sub>S</sub> = 0 to 20kΩ R <sub>L</sub> ≥ 10kΩ (in all combinations)	—	0.2	0.35	—	0.4	0.8	mV
Input Offset Voltage	V <sub>OS</sub>	V <sub>IN</sub> = 0V, R <sub>S</sub> = 50Ω	—	80	280	—	120	400	μV
Large-Signal Voltage Gain Error	A <sub>VE</sub>	R <sub>L</sub> ≥ 10kΩ, V <sub>O</sub> = ±10V	—	0.002	0.0035	—	0.002	0.008	%
Average Input Offset Voltage Drift	TCV <sub>OS</sub>	(Note 2)	—	0.2	1.8	—	0.3	2.5	μV/°C
Input Current	I <sub>IN</sub>		—	—	±12	—	—	±12	nA
Average Input Current Drift	TCI <sub>IN</sub>	(Note 2)	—	10	120	—	12	120	pA/°C
Input Voltage Range	V <sub>IN</sub>		±11.5	±12.6	—	±11.0	±12.6	—	V
Power Supply Rejection Ratio	PSRR	V <sub>S</sub> = ±3V to ±18V	—	7	32	—	10	51	μV/V
Power Consumption	P <sub>d</sub>	V <sub>O</sub> = 0	—	80	150	—	90	180	mW

**NOTES:**

- Guaranteed by design.
- Sample tested.

TYPICAL PERFORMANCE CURVES

BUF-01 LOW FREQUENCY NOISE

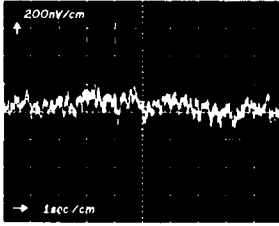

SMALL-SIGNAL TRANSIENT RESPONSE

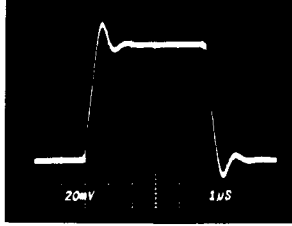

LARGE-SIGNAL TRANSIENT RESPONSE

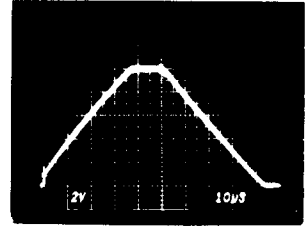

TOTAL INPUT NOISE VOLTAGE vs FREQUENCY

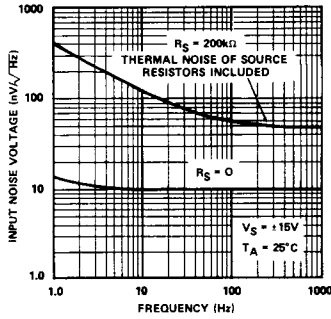

INPUT WIDEBAND NOISE vs BANDWIDTH (0.1Hz TO FREQUENCY INDICATED)

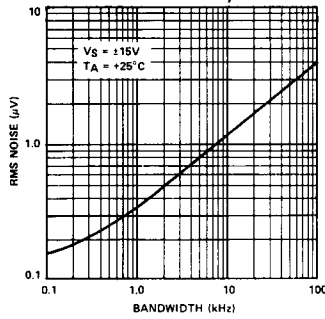

OFFSET VOLTAGE STABILITY vs TIME

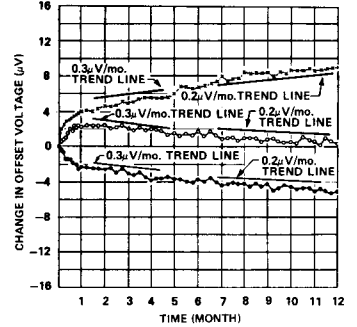

TRIMMED OFFSET VOLTAGE vs TEMPERATURE

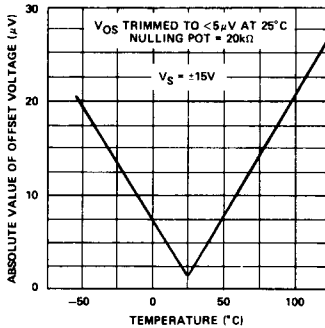

INPUT BIAS CURRENT vs TEMPERATURE

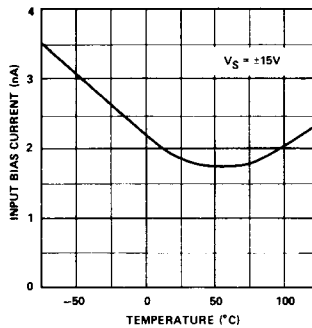

POWER CONSUMPTION vs POWER SUPPLY

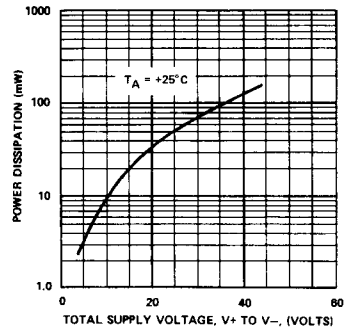

TYPICAL PERFORMANCE CURVES

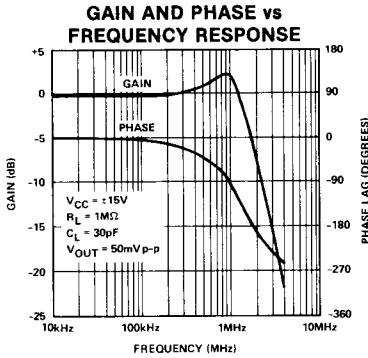
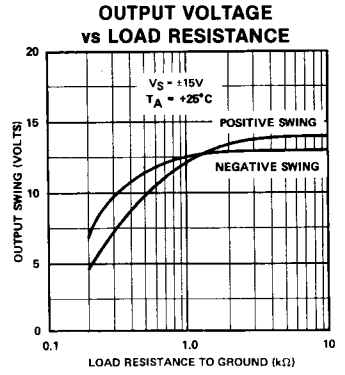
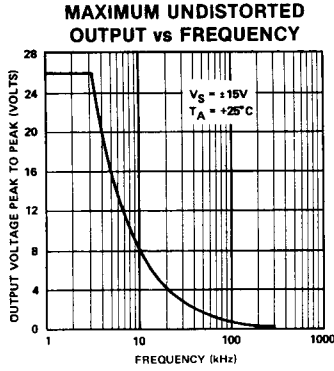
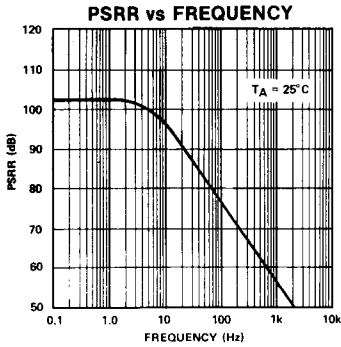

SECOND-ORDER LOWPASS FILTER

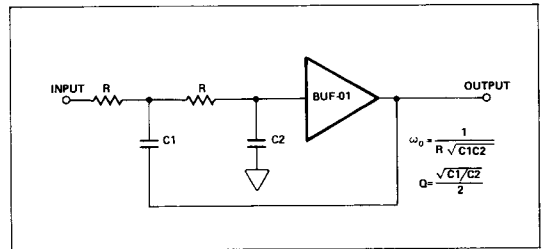

TYPICAL APPLICATIONS

SECOND-ORDER HIGHPASS FILTER

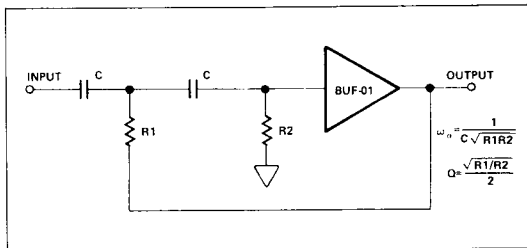

HIGH-IMPEDANCE DIFFERENTIAL AMPLIFIER

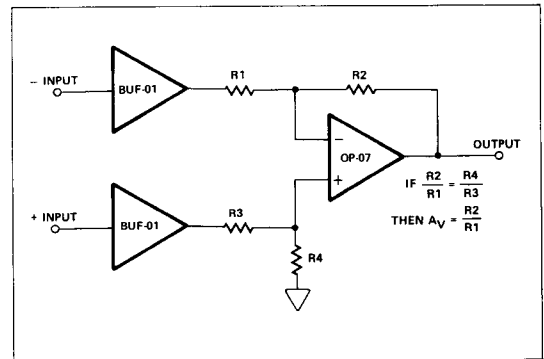

**BUFFERED REFERENCE**

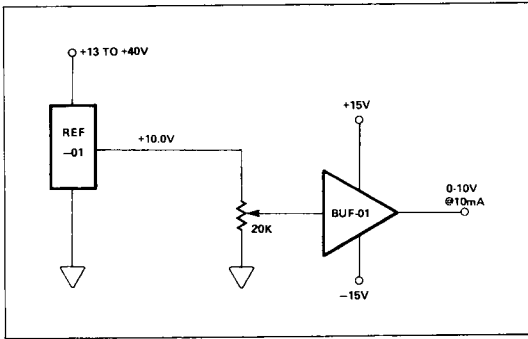

**TRANSIENT RESPONSE TEST CIRCUIT**

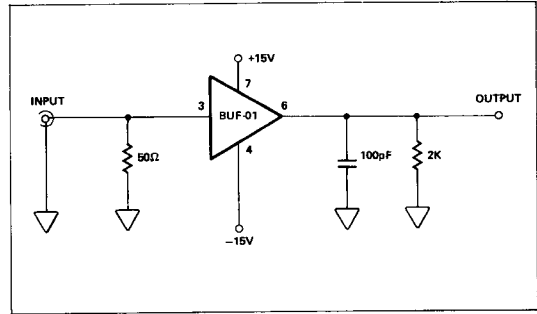

**HIGH RESOLUTION ADC INPUT BUFFER**

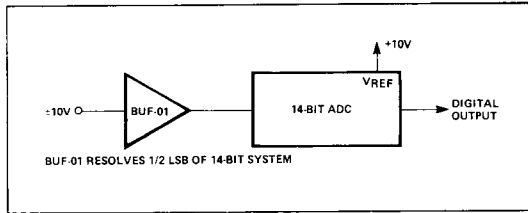

**MAXIMUM OUTPUT ERROR**

The **Maximum Output Error** specification combines errors introduced by offset voltage, input bias current, gain, CMRR, and device output impedance. The specification is 100% tested for a given combination of source resistance, load resistance, and input voltages. The tedious chore of performing a worst case summation of component error terms is not necessary.

**BURN-IN CIRCUIT**

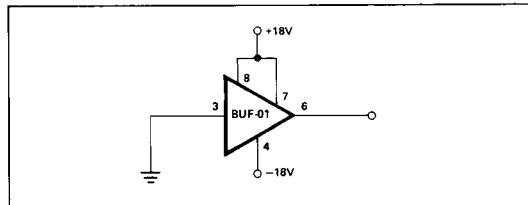

To assist the designer who has a specific application, the individual parameters of offset voltage, input current, voltage gain and PSRR are also given.

It should be noted that an error analysis may yield a figure higher than the Maximum Output Error specification. This is due to the potential cancellation of the effects of one error source by another. In situations such as this, the Maximum Output Error specification supersedes results from any error analysis.