

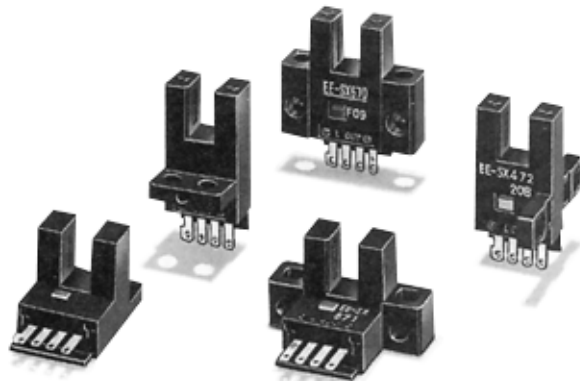



EE-SX470/471/472/473/474/670/671/672/673/674(P)

Photomicrosensor with 50 mA (PNP) or 100 mA (NPN) Switching Capacity that can be Built into Equipment

- New PNP models are now available
- Standard, L-shaped, T-shaped, and close mounting models available
- Models available with Light-ON or Light-ON/Dark-ON output configurations
- Response frequency as high as 1 kHz
- Easy operation monitoring with bright LED indicator
- Wide operating voltage range (5 to 24 VDC) makes smooth connection of the photomicrosensor with TTLs, relays, and programmable controllers (PLC) possible





Ordering Information

Appearance	Sensing method	Slot width	Slot depth	Output configuration	Weight	Part number
	Transmissive	5 mm	9 mm	Light-ON	Approx. 3.1 g	EE-SX470 EE-SX470P
				Light-ON/Dark-ON*		EE-SX670 EE-SX670P
				Light-ON	Approx. 3.0 g	EE-SX471 EE-SX471P
				Light-ON/Dark-ON*		EE-SX671 EE-SX671P
				Light-ON	Approx. 2.4 g	EE-SX472 EE-SX472P
				Light-ON/Dark-ON*		EE-SX672 EE-SX672P

*The EE-SX67□ series models can be used as Light-ON models when the L terminal and positive (+) terminal are short-circuited. To use them as Dark-ON models do not short-circuit these terminals. Connector EE-1001-1 can be used for Light-ON operation.

(This table continues on the next page.)

Ordering Information Table - continued from previous page

Appearance	Sensing method	Slot width	Slot depth	Output configuration	Weight	Part number
	Transmissive	5 mm	9 mm	Light-ON	Approx. 2.3 g	EE-SX473 EE-SX473P
				Light-ON/Dark-ON*		EE-SX673 EE-SX673P
				Light-ON	Approx. 3.0 g	EE-SX474 EE-SX474P
				Light-ON/Dark-ON		EE-SX674 EE-SX674P

*The EE-SX67□ series models can be used as Light-ON models when the L terminal and positive (+) terminal are short-circuited. To use them as Dark-ON models do not short-circuit these terminals. Connector EE-1001-1 can be used for Light-ON operation.

Specifications

RATINGS

Item		Standard	L-shaped	T-shaped	Close-mounting
	NPN output	EE-SX470 EE-SX670	EE-SX471 EE-SX671	EE-SX472 EE-SX672	EE-SX473, EE-SX474 EE-SX673, EE-SX674
	PNP output	EE-SX470P EE-SX670P	EE-SX471P EE-SX671P	EE-SX472P EE-SX672P	EE-SX473P, EE-SX474P EE-SX673P, EE-SX674P
Supply voltage		5 to 24 VDC ±10%, ripple (p-p): 10% max.			
Current consumption		NPN models: 35 mA max., PNP models: 30 mA max.			
Standard reference object		Opaque: 0.8 x 2 mm			
Differential distance		0.025 mm			
Control output		NPN open collector output models: At 5 to 24 VDC: 100 mA load current (I_c) with a residual voltage of 0.8 V max. When driving TTL: 40 mA load current (I_c) with a residual voltage of 0.4 V max. PNP open collector output models: At 5 to 24 VDC: 50 mA load current (I_c) with a residual voltage of 1.3 V max.			
Indicator*	Without detecting object	ON			
	With detecting object	OFF			
Response frequency**		1 kHz max. (3 kHz typ.)			
Light source		GaAs infrared LED with a peak wavelength of 940 nm			
Receiver		Si phototransistor with a sensing wavelength of 850 nm max.			
Connecting method		EE-1001/1006 Connectors; soldering terminals			

*The indicator is GaP red LED (peak emission wavelength: 690 nm).

**The response frequency was measured by detecting the following disks rotating.

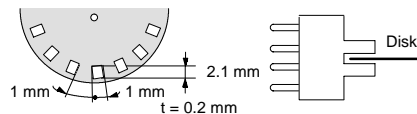

CHARACTERISTICS

Ambient illumination*		Fluorescent light: 1,000 lx max.
Ambient temperature	Operating	-25°C to 55°C (-13°F to 131°F)
	Storage	-30°C to 80°C (-22°F to 176°F)
Ambient humidity	Operating	5% to 85%
	Storage	5% to 95%
Vibration resistance		Destruction: 20 to 2,000 Hz, (with a peak acceleration of 10 G), 1.5-mm double amplitude for 2 hrs (with 4-minute cycles) each in X, Y, and Z directions
Shock resistance		Destruction: 500 m/s ² (approx. 50G) for 3 times each in X, Y, and Z directions
Soldering heat resistance**		260±5°C when the portion between the tip of the terminals and the position 1.5 mm from the terminal base is dipped into the solder for 10±1 seconds
Degree of protection		IEC 60529, IP50
Materials	Case	Polybutylene phthalate (PBT)
	Cover	Polycarbonate (PC)
	Emitter/Receiver	Polycarbonate (PC)

*The ambient luminance is measured on the surface of the receiver.

**This conforms to MIL-STD-750-2031-1.

Engineering Data

SENSING POSITION CHARACTERISTICS (TYPICAL)

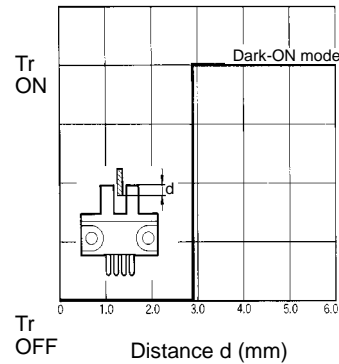
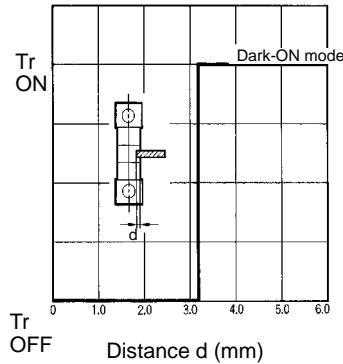

REPEATED SENSING POSITION CHARACTERISTICS (TYPICAL)

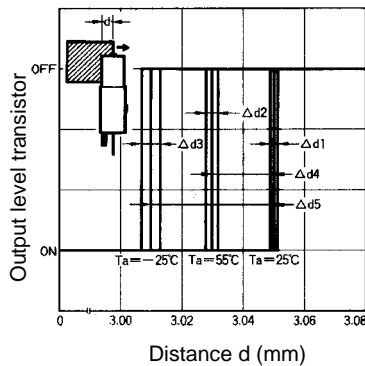

No. of repetitions: 20 at $V_{CC} = 12\text{ V}$

$\Delta d1 = 0.002\text{ mm}$

$\Delta d2 = 0.004\text{ mm}$

$\Delta d3 = 0.005\text{ mm}$

$\Delta d4 = 0.02\text{ mm}$

$\Delta d5 = 0.04\text{ mm}$

Operation

Output configuration	Model	Output transistor operation	Timing charts	Output circuit
NPN output	EE-SX670 EE-SX671 EE-SX672 EE-SX673 EE-SX674	Light-ON	(When terminals L and ⊕ are short circuited) Incident Interrupted Operation indicator (red) ON OFF Output transistor ON OFF Load 1 (relay) Operates Releases Load 2 H L	<p>Note: When using a voltage output, always insert a resistor in R_L.</p>
		Dark-ON	Incident Interrupted Operation indicator (red) ON OFF Output transistor ON OFF Load 1 (relay) Operates Releases Load 2 H L	
NPN output	EE-SX470 EE-SX471 EE-SX472 EE-SX473 EE-SX474	Light-ON	Incident Interrupted Operation indicator (red) ON OFF Output transistor ON OFF Load 1 (relay) Operates Releases Load 2 H L	<p>Note: When using a voltage output, always insert a resistor in R_L.</p>
		Dark-ON	Incident Interrupted Operation indicator (red) ON OFF Output transistor ON OFF Load 1 (relay) Operates Releases Load 2 H L	
PNP output	EE-SX670P EE-SX671P EE-SX672P EE-SX673P EE-SX674P	Light-ON	(When terminals L and ⊕ are short circuited) Incident Interrupted Operation indicator (red) ON OFF Output transistor ON OFF Load (relay) Operates Releases Voltage output H L	<p>Note: When using a voltage output, always insert a resistor in R_L.</p>
		Dark-ON	Incident Interrupted Operation indicator (red) ON OFF Output transistor ON OFF Load 1 (relay) Operates Releases Load 2 H L	
PNP output	EE-SX470P EE-SX471P EE-SX472P EE-SX473P EE-SX474P	Light-ON	Incident Interrupted Operation indicator (red) ON OFF Output transistor ON OFF Load (relay) Operates Releases Voltage output H L	<p>Note: When using a voltage output, always insert a resistor in R_L.</p>
		Dark-ON	Incident Interrupted Operation indicator (red) ON OFF Output transistor ON OFF Load 1 (relay) Operates Releases Load 2 H L	

Dimensions

Unit: mm (inch)

EE-SX470(P), EE-SX670(P)

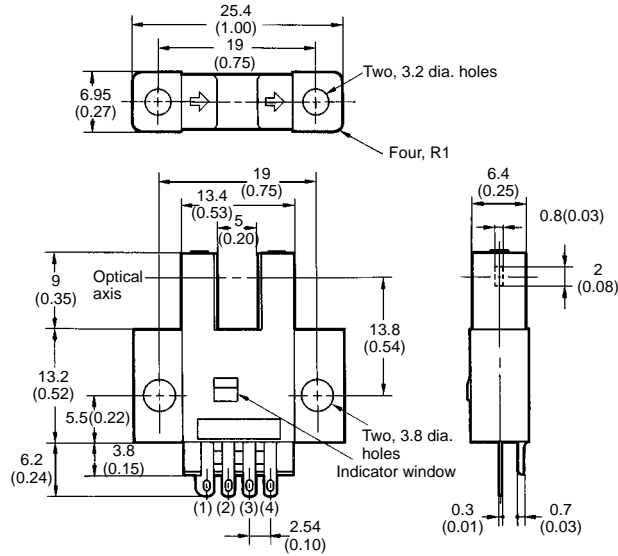
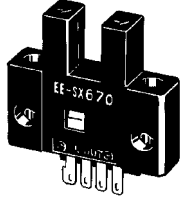

Terminal Arrangement

(1)	⊕	V _{CC}
(2)	L	L (See Note.)
(3)	OUT	OUTPUT
(4)	⊖	GND (0 V)

Note: L Terminal needs no connection for all EE-SX47□ series sensors.

EE-SX471(P), EE-SX671(P)

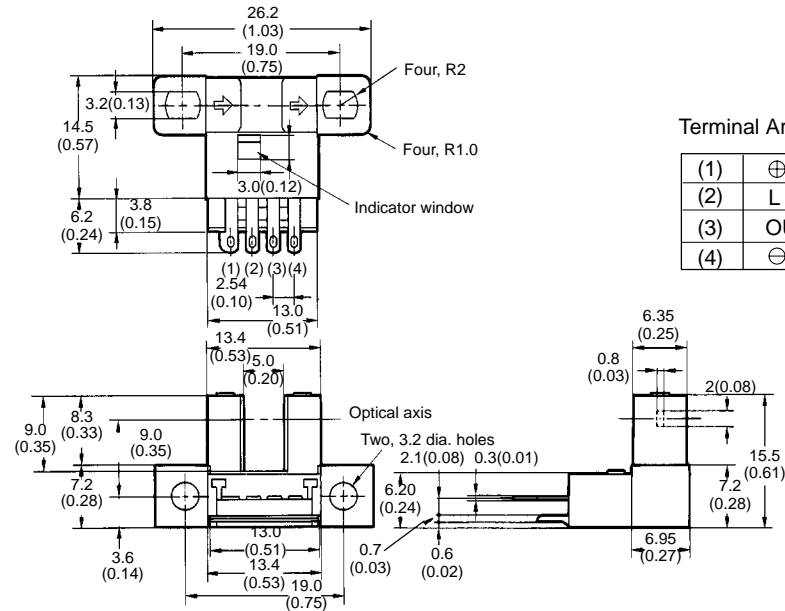
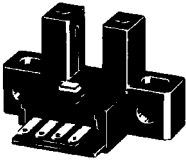

Terminal Arrangement

(1)	⊕	V _{CC}
(2)	L	L (See Note.)
(3)	OUT	OUTPUT
(4)	⊖	GND (0 V)

Note: L Terminal needs no connection for all EE-SX47□ series sensors.

■ EE-SX472(P), EE-SX672(P)

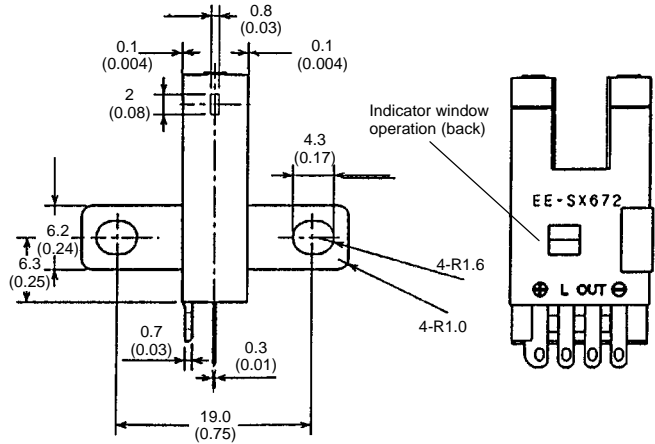
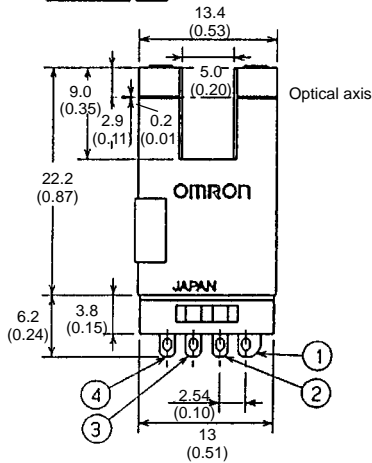
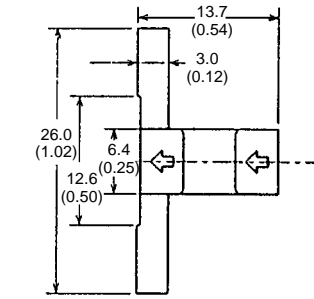
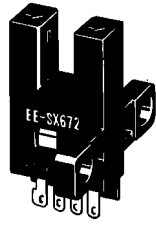

Terminal Arrangement

(1)	⊕	V _{CC}
(2)	L	L (See Note.)
(3)	OUT	OUTPUT
(4)	⊖	GND (0 V)

Note: L Terminal needs no connection for all EE-SX47□ series sensors.

■ EE-SX473(P), EE-SX673(P)

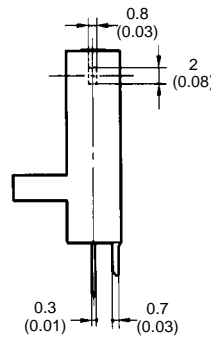
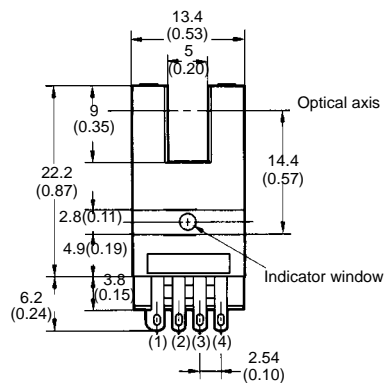
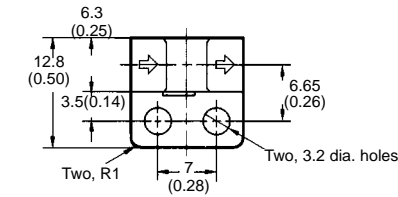
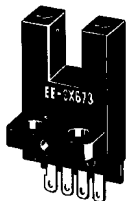

Terminal Arrangement

(1)	⊕	V _{CC}
(2)	L	L (See Note.)
(3)	OUT	OUTPUT
(4)	⊖	GND (0 V)

Note: L Terminal needs no connection for all EE-SX47□ series sensors.

■ EE-SX474(P), EE-SX674(P)

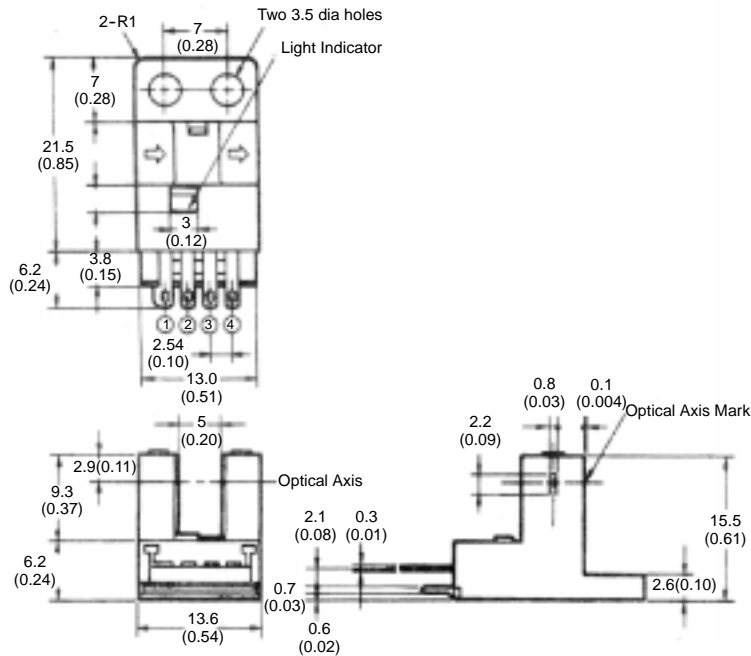
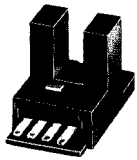

Terminal Arrangement

(1)	⊕	V _{CC}
(2)	L	L (See Note.)
(3)	OUT	OUTPUT
(4)	⊖	GND (0 V)

Note: L Terminal needs no connection for all EE-SX47□ series sensors.

■ EE-1001 CONNECTOR

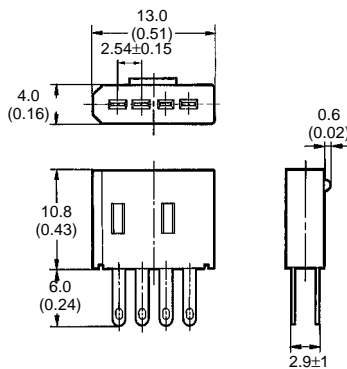
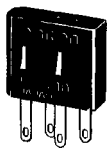

■ EE-SX67□(P) WITH EE-1001 CONNECTOR

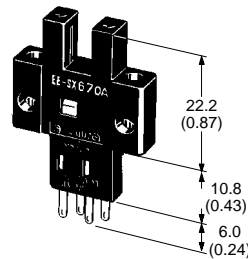

■ EE-1006 CONNECTOR WITH CABLE

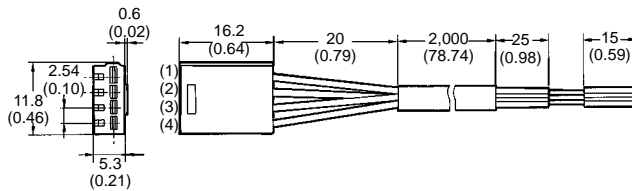
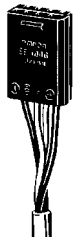

Terminal Arrangement - IEC Colors

(1)	Brown (Red)	⊕	V _{CC}
(2)	Pink (Yellow)	L	L
(3)	Black (White)	OUT	OUTPUT
(4)	Blue (Black)	⊖	GND (0 V)

Note: Older standard colors are shown in parentheses. Connector comes with a 2-m attached cable.

■ **EE-1006A CONNECTOR HOLDER**

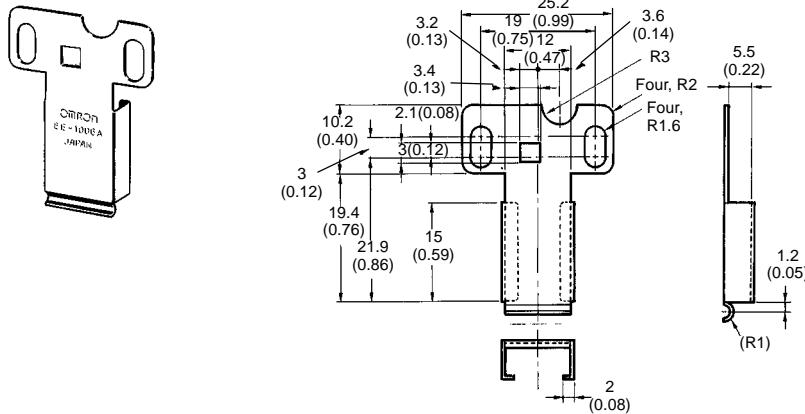

Precautions

Refer to the the Technical Information Section for general precautions.

The sensing window is made of a polycarbonate resin which withstands chloride solvents and strong acids but is soluble in strong alkali, aromatic hydrocarbons, and aliphatic hydrocarbonate chloride solvents.

The casing material uses a PBT resin which withstands chemicals and oil but is soluble in strong acid or alkali solvents.

The temperature of the terminals at the time of soldering must not exceed the following:

Item	Temperature	Permissible time	Remarks
Dip	260°C	10 sec	The portion between the base of the terminals and the position 1.5 mm from the terminal base must not be soldered.
Iron	350°C	3 sec	

The terminal base uses a polycarbonate resin, which could be deformed by excessive soldering heat.

NOTE: DIMENSIONS SHOWN ARE IN MILLIMETERS. To convert millimeters to inches divide by 25.4.

OMRON®
OMRON ELECTRONICS, INC.
 One East Commerce Drive
 Schaumburg, IL 60173
1-800-55-OMRON

OMRON CANADA, INC.
 885 Milner Avenue
 Scarborough, Ontario M1B 5V8
416-286-6465