

## 1 Form A Solid State Relay (Low Capacitance)

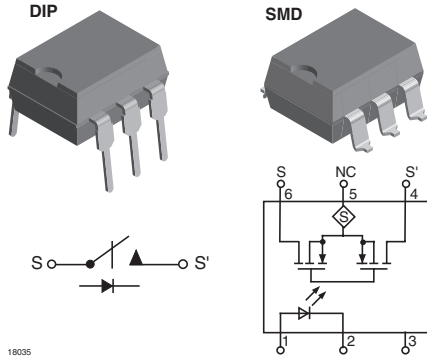

### FEATURES

- Low capacitance switch (5.0 pF)
- Isolation test voltage 5300 V<sub>RMS</sub>
- Extremely high off-resistance (100 GΩ)
- Load voltage 200 V
- Clean bounce free switching
- Low power consumption
- High reliability monolithic receptor
- Lead (Pb)-free component
- Component in accordance to RoHS 2002/95/EC and WEEE 2002/96/EC



**RoHS**  
COMPLIANT

### DESCRIPTION

These SSRs (LH1541, 1 form A) are SPST normally open switches which can replace electromechanical relays in many applications. The relays provide a low capacitance, high-voltage switch contact with high off resistance and low switch-offset voltage. These characteristics, combined with high-speed actuation, result in an SSR which is ideal for small signal and DC instrumentation applications.

The relays are constructed by using a GaAlAs LED for actuation control and an integrated monolithic die for the switch output. The die is comprised of a photodiode array, switch-control circuitry, and low-capacitance MOSFET switches.

### APPLICATIONS

- Instrumentation
  - Thermocouple switching
  - Analog multiplexing
- Reed relay replacement
- Programmable logic controllers
- Data acquisition
- Test equipment

### AGENCY APPROVALS

- UL1577: file no. E52744 system code H or J, double protection
- CSA: certification no. 093751
- BSI/BABT: certification no. 7980
- DIN EN: 60747-5-5 (VDE 0884)
- FIMKO: approval

ORDER INFORMATION		
PART	REMARKS	PACKAGE
LH1541AAB1	Tubes	SMD-6
LH1541AAB1TR	Tape and reel	SMD-6
LH1541AT1	Tubes	DIP-6

ABSOLUTE MAXIMUM RATINGS (1)				
PARAMETER	TEST CONDITION	SYMBOL	VALUE	UNIT
<b>SSR</b>				
LED continuous forward current		I <sub>F</sub>	50	mA
LED reverse voltage	I <sub>R</sub> ≤ 10 μA	V <sub>R</sub>	8.0	V
DC or peak AC load voltage	I <sub>L</sub> ≤ 50 μA	V <sub>L</sub>	200	V
Continuous DC load current - bidirectional operation		I <sub>L</sub>	55	mA
Peak load current (single shot)	t = 100 ms	I <sub>P</sub>	100	mA
Ambient temperature range		T <sub>amb</sub>	- 40 to + 85	°C

# LH1541AAB1/LH1541AAB1TR/LH1541AT1



Vishay Semiconductors 1 Form A Solid State Relay (Low Capacitance)

ABSOLUTE MAXIMUM RATINGS <sup>(1)</sup>				
PARAMETER	TEST CONDITION	SYMBOL	VALUE	UNIT
<b>SSR</b>				
Storage temperature range		T <sub>stg</sub>	- 40 to + 150	°C
Pin soldering temperature <sup>(2)</sup>	t = 10 s max.	T <sub>sld</sub>	260	°C
Input to output isolation voltage		V <sub>ISO</sub>	5300	V <sub>RMS</sub>
Output power dissipation (continuous)		P <sub>diss</sub>	550	mW

## Notes

<sup>(1)</sup> T<sub>amb</sub> = 25 °C, unless otherwise specified.

Stresses in excess of the absolute maximum ratings can cause permanent damage to the device. Functional operation of the device is not implied at these or any other conditions in excess of those given in the operational sections of this document. Exposure to absolute maximum ratings for extended periods of the time can adversely affect reliability.

<sup>(2)</sup> Refer to reflow profile for soldering conditions for surface mounted devices (SMD). Refer to wave profile for soldering conditions for through hole devices (DIP).

ELECTRICAL CHARACTERISTICS						
PARAMETER	TEST CONDITION	SYMBOL	MIN.	TYP.	MAX.	UNIT
<b>INPUT</b>						
LED forward current, switch turn-on	I <sub>L</sub> = 100 mA, t = 10 ms	I <sub>Fon</sub>		0.6	2.0	mA
LED forward current, switch turn-off	V <sub>L</sub> = ± 150 V	I <sub>Foff</sub>	0.1	0.5		mA
LED forward voltage	I <sub>F</sub> = 5.0 mA	V <sub>F</sub>	1.1	1.26	1.45	V
<b>OUTPUT</b>						
On-resistance, AC/DC, pin 4 (±) to 6 (±)	I <sub>F</sub> = 5.0 mA, I <sub>L</sub> = 50 mA	R <sub>ON</sub>	70	110	160	Ω
Off-resistance	I <sub>F</sub> = 0 mA, V <sub>L</sub> = ± 100 V	R <sub>OFF</sub>	0.5	250		GΩ
Off-state leakage current	I <sub>F</sub> = 0 mA, V <sub>L</sub> = ± 100 V	I <sub>O</sub>		0.4	200	nA
	I <sub>F</sub> = 0 mA, V <sub>L</sub> = ± 200 V	I <sub>O</sub>			1.0	μA
Output capacitance pin 4 to 6	I <sub>F</sub> = 0 mA, V <sub>L</sub> = 1.0 V	C <sub>O</sub>		4.8		pF
	I <sub>F</sub> = 0 mA, V <sub>L</sub> = 50 V	C <sub>O</sub>		36		pF
Switch offset	I <sub>F</sub> = 5.0 mA	V <sub>OS</sub>		0.15		μV
<b>TRANSFER</b>						
Capacitance (input to output)	V <sub>ISO</sub> = 1.0 V	C <sub>IO</sub>		0.8		pF
Turn-on time	I <sub>F</sub> = 5.0 mA, I <sub>L</sub> = 50 mA	t <sub>on</sub>		0.2	0.5	ms
Turn-off time	I <sub>F</sub> = 5.0 mA, I <sub>L</sub> = 50 mA	t <sub>off</sub>		0.3	0.5	ms

## Note

T<sub>amb</sub> = 25 °C, unless otherwise specified.

Minimum and maximum values are testing requirements. Typical values are characteristics of the device and are the result of engineering evaluations. Typical values are for information only and are not part of the testing requirements.



### TYPICAL CHARACTERISTICS

$T_{amb} = 25\text{ }^{\circ}\text{C}$ , unless otherwise specified

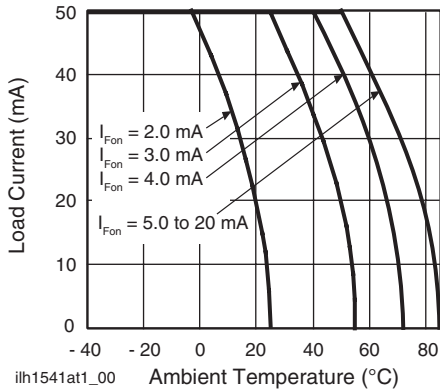

Fig. 1 - Recommended Operating Conditions

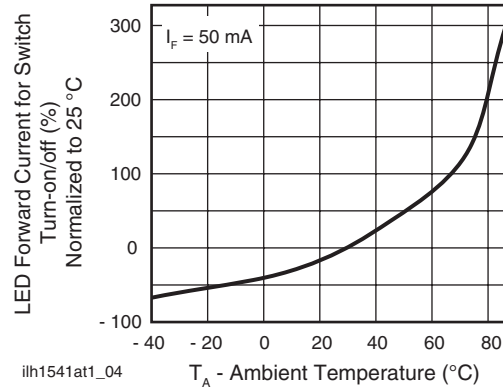

Fig. 4 - LED Current for Switch Turn-on vs. Temperature

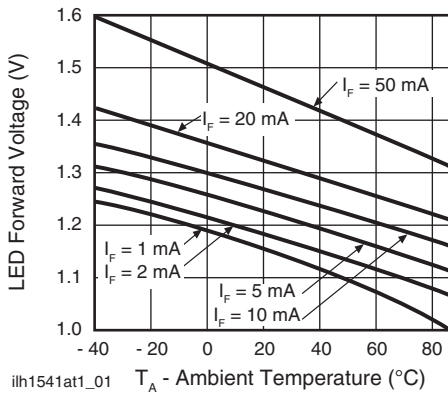

Fig. 2 - LED Voltage vs. Temperature

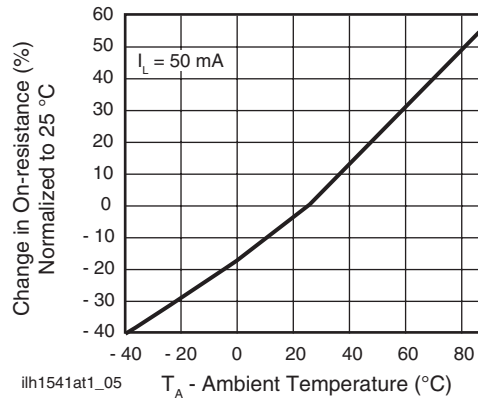

Fig. 5 - On-resistance vs. Temperature

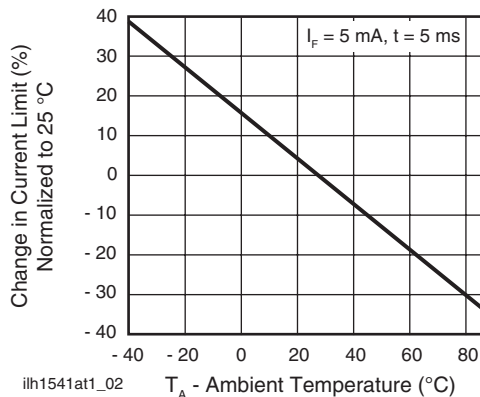

Fig. 3 - Current Limit vs. Temperature

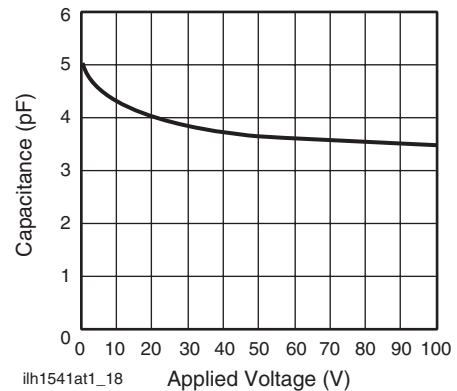

Fig. 6 - Switch Capacitance vs. Applied Voltage

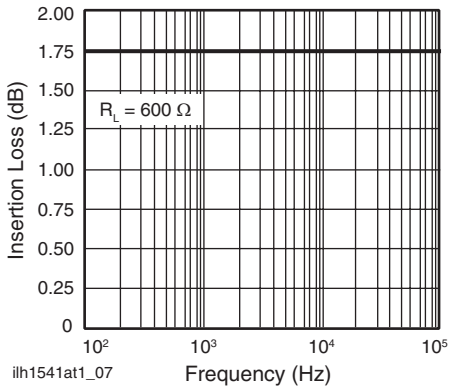

Fig. 7 - Insertion Loss vs. Frequency

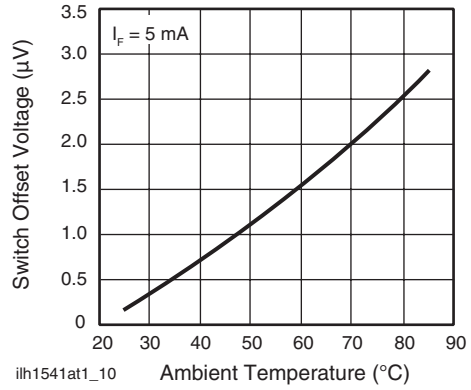

Fig. 10 - Switch Offset Voltage vs. Temperature

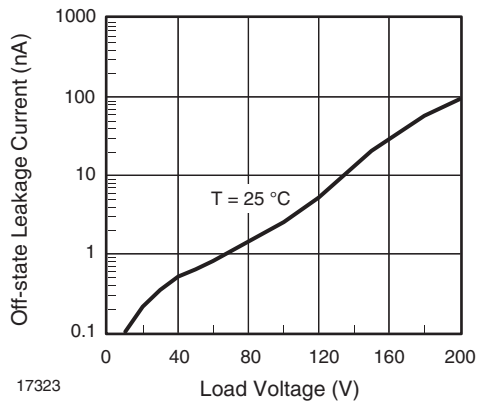

Fig. 8 - Leakage Current vs. Applied Voltage

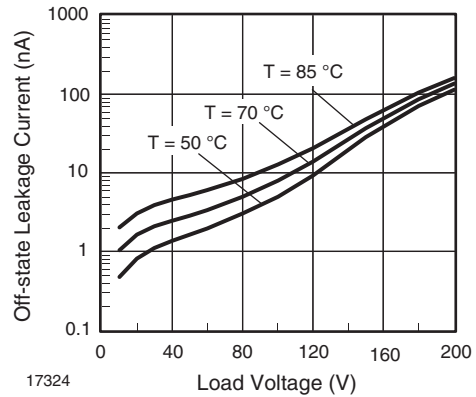

Fig. 11 - Leakage Current vs. Applied Voltage at Elevated Temperatures

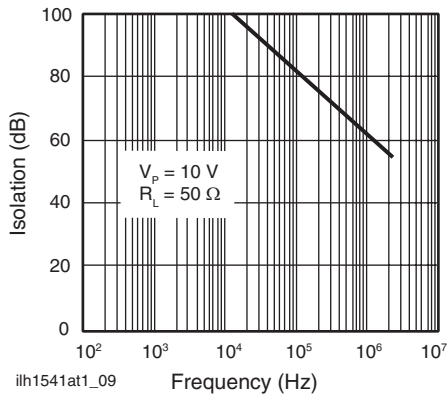

Fig. 9 - Output Isolation

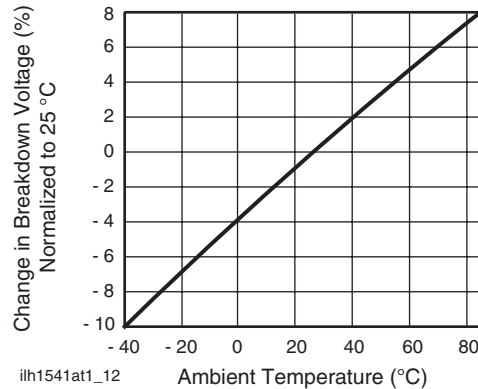

Fig. 12 - Switch Breakdown Voltage vs. Temperature



# LH1541AAB1/LH1541AAB1TR/LH1541AT1

1 Form A Solid State Relay (Low Capacitance)

Vishay Semiconductors

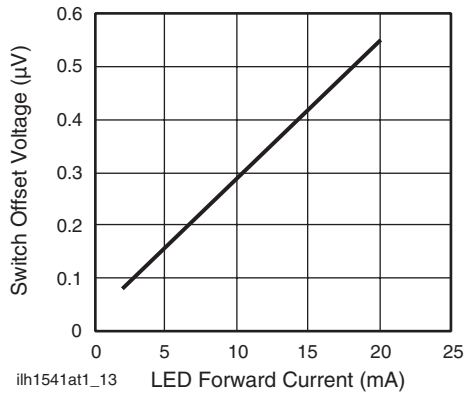

Fig. 13 - Switch Offset Voltage vs. LED Current

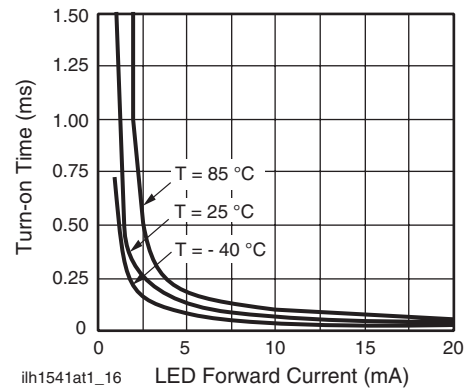

Fig. 16 - Turn-on Time vs. LED Current

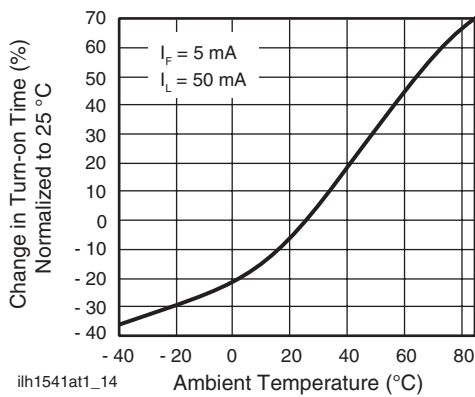

Fig. 14 - Turn-on Time vs. Temperature

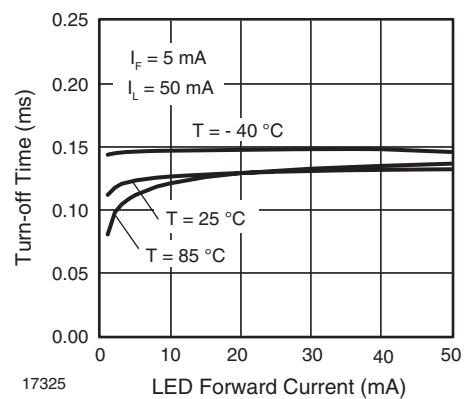

Fig. 17 - Turn-off Time vs. LED Current

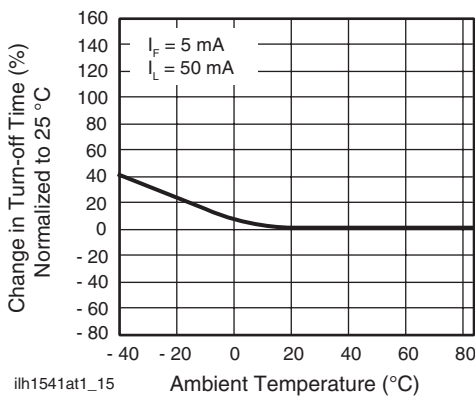

Fig. 15 - Turn-off Time vs. Temperature

# LH1541AAB1/LH1541AAB1TR/LH1541AT1



Vishay Semiconductors 1 Form A Solid State Relay (Low Capacitance)

## PACKAGE DIMENSIONS in inches (millimeters)

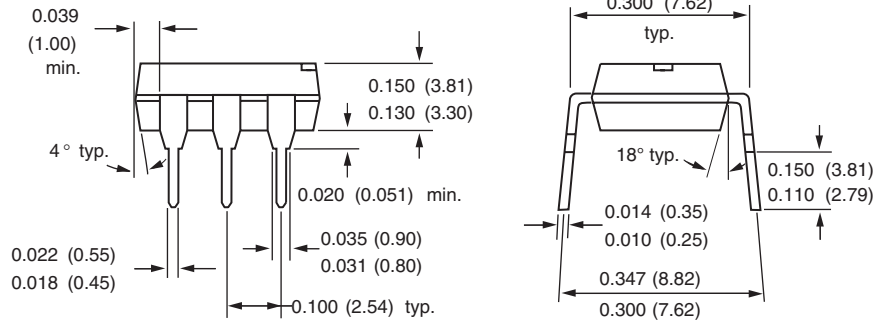
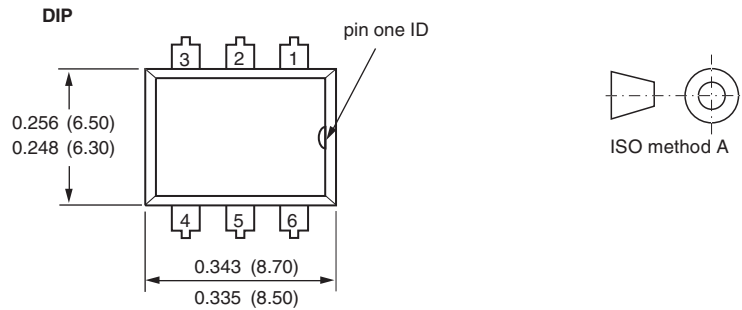

i178001

## SMD

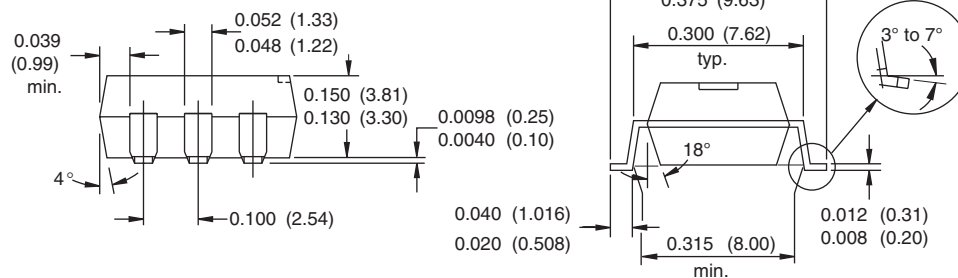
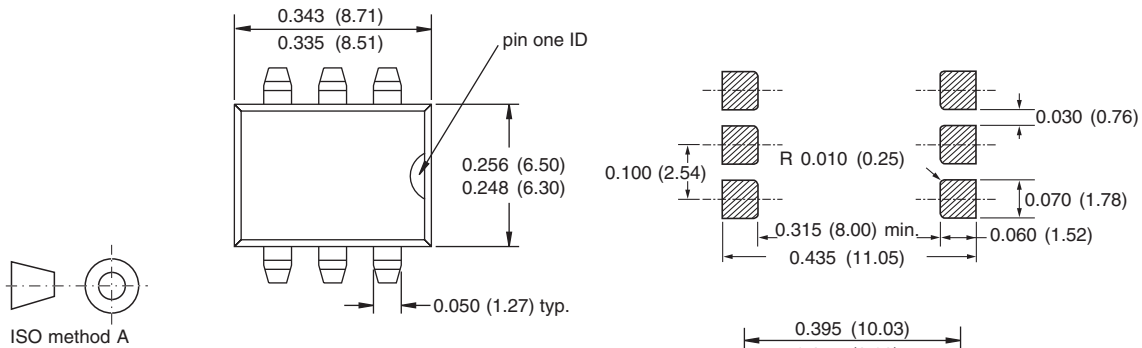

i178002



## OZONE DEPLETING SUBSTANCES POLICY STATEMENT

It is the policy of Vishay Semiconductor GmbH to

1. Meet all present and future national and international statutory requirements.
2. Regularly and continuously improve the performance of our products, processes, distribution and operating systems with respect to their impact on the health and safety of our employees and the public, as well as their impact on the environment.

It is particular concern to control or eliminate releases of those substances into the atmosphere which are known as ozone depleting substances (ODSs).

The Montreal Protocol (1987) and its London Amendments (1990) intend to severely restrict the use of ODSs and forbid their use within the next ten years. Various national and international initiatives are pressing for an earlier ban on these substances.

Vishay Semiconductor GmbH has been able to use its policy of continuous improvements to eliminate the use of ODSs listed in the following documents.

1. Annex A, B and list of transitional substances of the Montreal Protocol and the London Amendments respectively.
2. Class I and II ozone depleting substances in the Clean Air Act Amendments of 1990 by the Environmental Protection Agency (EPA) in the USA.
3. Council Decision 88/540/EEC and 91/690/EEC Annex A, B and C (transitional substances) respectively.

Vishay Semiconductor GmbH can certify that our semiconductors are not manufactured with ozone depleting substances and do not contain such substances.

We reserve the right to make changes to improve technical design  
and may do so without further notice.

Parameters can vary in different applications. All operating parameters must be validated for each customer application by the customer. Should the buyer use Vishay Semiconductors products for any unintended or unauthorized application, the buyer shall indemnify Vishay Semiconductors against all claims, costs, damages, and expenses, arising out of, directly or indirectly, any claim of personal damage, injury or death associated with such unintended or unauthorized use.

Vishay Semiconductor GmbH, P.O.B. 3535, D-74025 Heilbronn, Germany



## Disclaimer

All product specifications and data are subject to change without notice.

Vishay Intertechnology, Inc., its affiliates, agents, and employees, and all persons acting on its or their behalf (collectively, "Vishay"), disclaim any and all liability for any errors, inaccuracies or incompleteness contained herein or in any other disclosure relating to any product.

Vishay disclaims any and all liability arising out of the use or application of any product described herein or of any information provided herein to the maximum extent permitted by law. The product specifications do not expand or otherwise modify Vishay's terms and conditions of purchase, including but not limited to the warranty expressed therein, which apply to these products.

No license, express or implied, by estoppel or otherwise, to any intellectual property rights is granted by this document or by any conduct of Vishay.

The products shown herein are not designed for use in medical, life-saving, or life-sustaining applications unless otherwise expressly indicated. Customers using or selling Vishay products not expressly indicated for use in such applications do so entirely at their own risk and agree to fully indemnify Vishay for any damages arising or resulting from such use or sale. Please contact authorized Vishay personnel to obtain written terms and conditions regarding products designed for such applications.

Product names and markings noted herein may be trademarks of their respective owners.