

Notice for TAIYO YUDEN products

Please read this notice before using the TAIYO YUDEN products.

REMINDERS

- Product information in this catalog is as of October 2013. All of the contents specified herein are subject to change without notice due to technical improvements, etc. Therefore, please check for the latest information carefully before practical application or usage of the Products.

Please note that TAIYO YUDEN CO., LTD. shall not be responsible for any defects in products or equipment incorporating such products, which are caused under the conditions other than those specified in this catalog or individual specification.

- Please contact TAIYO YUDEN CO., LTD. for further details of product specifications as the individual specification is available.

- Please conduct validation and verification of products in actual condition of mounting and operating environment before commercial shipment of the equipment.

- All electronic components or functional modules listed in this catalog are developed, designed and intended for use in general electronics equipment.(for AV, office automation, household, office supply, information service, telecommunications, (such as mobile phone or PC) etc.). Before incorporating the components or devices into any equipment in the field such as transportation,(automotive control, train control, ship control), transportation signal, disaster prevention, medical, public information network (telephone exchange, base station) etc. which may have direct influence to harm or injure a human body, please contact TAIYO YUDEN CO., LTD. for more detail in advance.

Do not incorporate the products into any equipment in fields such as aerospace, aviation, nuclear control, submarine system, military, etc. where higher safety and reliability are especially required.

In addition, even electronic components or functional modules that are used for the general electronic equipment, if the equipment or the electric circuit require high safety or reliability function or performances, a sufficient reliability evaluation check for safety shall be performed before commercial shipment and moreover, due consideration to install a protective circuit is strongly recommended at customer's design stage.

- The contents of this catalog are applicable to the products which are purchased from our sales offices or distributors (so called "TAIYO YUDEN' s official sales channel").

It is only applicable to the products purchased from any of TAIYO YUDEN' s official sales channel.

- Please note that TAIYO YUDEN CO., LTD. shall have no responsibility for any controversies or disputes that may occur in connection with a third party's intellectual property rights and other related rights arising from your usage of products in this catalog. TAIYO YUDEN CO., LTD. grants no license for such rights.

- Caution for export

Certain items in this catalog may require specific procedures for export according to "Foreign Exchange and Foreign Trade Control Law" of Japan, "U.S. Export Administration Regulations", and other applicable regulations. Should you have any question or inquiry on this matter, please contact our sales staff.

BALUN TRANSFORMERS



MB: WAVE MC: REFLOW

PARTS NUMBER

*Operating Temp.: -25~+105°C (Including self-generated heat)

B	U	0	5	M	B	△	0	1	△	△	△
①	②	③	④	⑤	⑥						

△ = Blank space

① Series name

Code	Series name
BU	Balun transformer

② Dimensions of core

Code	Dimensions of core [mm]
05	5.0
	5.3
06	6.0

③ Shape

Code	Shape
MB	Pin type
MC	Surface mount type

④ Product classification code

Code (example)	Product classification code
△01	Product classification code

⑤ Packaging

Code	Packaging
△T	Taping
△△	Bulk (Only pin type)

⑥ Internal code

Code	Internal code
△	Standard

STANDARD EXTERNAL DIMENSIONS / MINIMUM QUANTITY

Pin type MB (BU05MB, BU06MB)	Surface mount type MC (BU05MC)	Recommended Land Patterns (BU05MC)

Unit: mm

Type	A	B	C	D	E	Minimum Quantity [pcs]	
						Box	Taping
BU05MB	5.5 max (0.217 max)	5.5 max (0.217 max)	6.0 max (0.236 max)	1.75±0.2 (0.069±0.008)	3.5 (0.138)	200	—
BU06MB	8.0 max (0.315 max)	8.0 max (0.315 max)	8.0 max (0.315 max)	2.25±0.2 pitch (0.089±0.008)	3.5~5.0 (0.138~0.197)	150	—
BU05MC	5.3±0.5 (0.209±0.020)	5.0±0.3 (0.197±0.012)	2.7±0.2 (0.106±0.008)	1.5±0.2 pitch (0.059±0.008)	—	—	2500

Unit: mm (inch)

ELECTRICAL CHARACTERISTICS

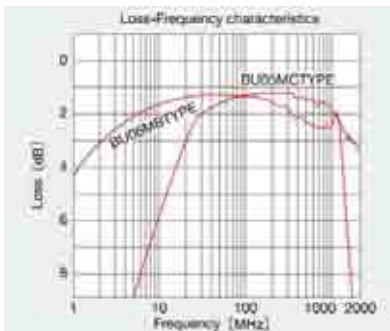

The following chart shows typical ranges for operating characteristics.

Please specify the following when ordering.

- ① loss
- ② standing wave ratio (VSWR)
- ③ operating frequency
- ④ specified test circuit

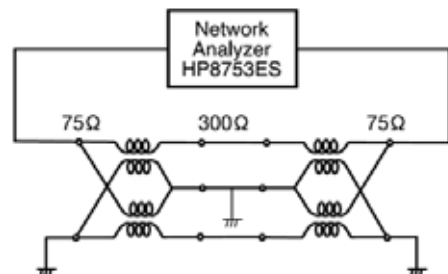

▶ This catalog contains the typical specification only due to the limitation of space. When you consider the purchase of our products, please check our specification. For details of each product (characteristics graph, reliability information, precautions for use, and so on), see our Web site (<http://www.ty-top.com/>).

SMD COMMON MODE CHOKE COILS FOR DC AND SIGNAL LINES, BALUN TRANSFORMERS

PACKAGING

① Minimum Quantity

Type	Minimum Quantity [pcs]	
	Box	Taping
BU05MC	—	2500
BU05MB	200	—
BU06MB	150	—

② Tape material

● Embossed Tape

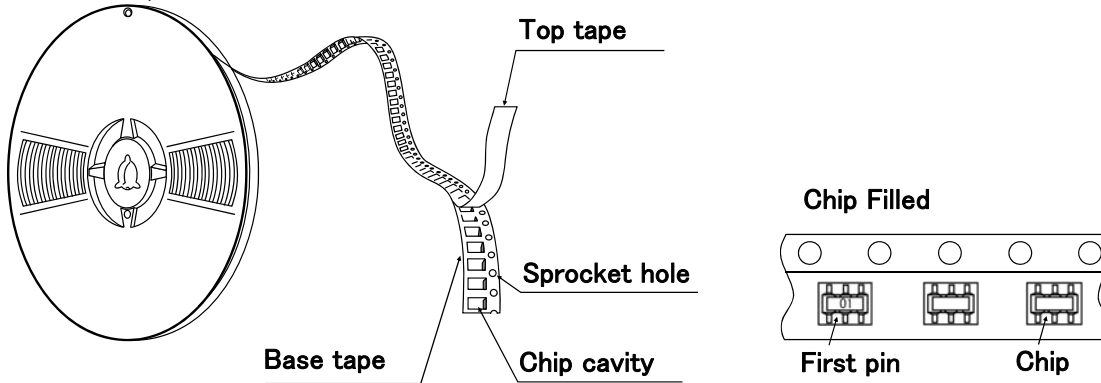

③ Taping dimensions

● Embossed tape 12mm wide (0.472 inches wide)

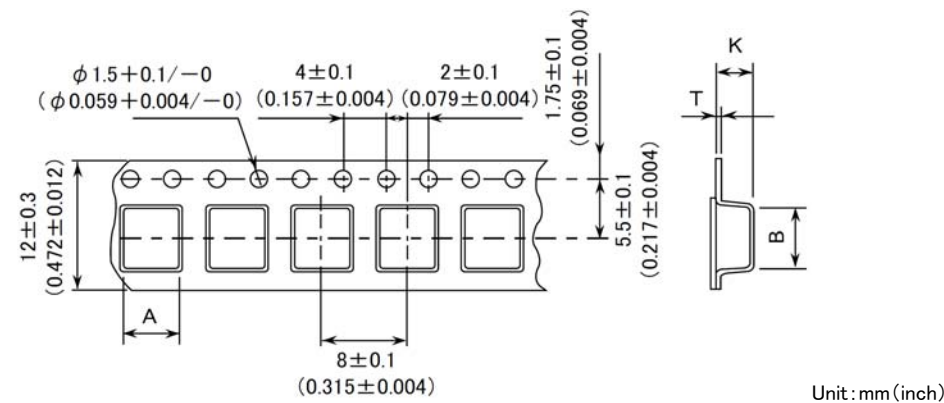

Type	Insertion pitch	Chip cavity		Tape thickness	
		A	B	K	T
BU05MC	8.0 ± 0.1 (0.315 ± 0.004)	5.2 ± 0.1 (0.205 ± 0.004)	5.6 ± 0.1 (0.220 ± 0.004)	3.2 ± 0.1 (0.126 ± 0.004)	0.4 ± 0.05 (0.016 ± 0.002)

Unit: mm (inch)

④ Leader and Blank portion

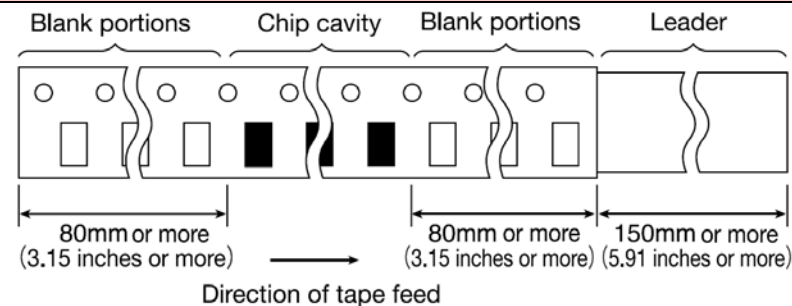

▶ This catalog contains the typical specification only due to the limitation of space. When you consider the purchase of our products, please check our specification. For details of each product (characteristics graph, reliability information, precautions for use, and so on), see our Web site (<http://www.ty-top.com/>).

⑤ Reel size

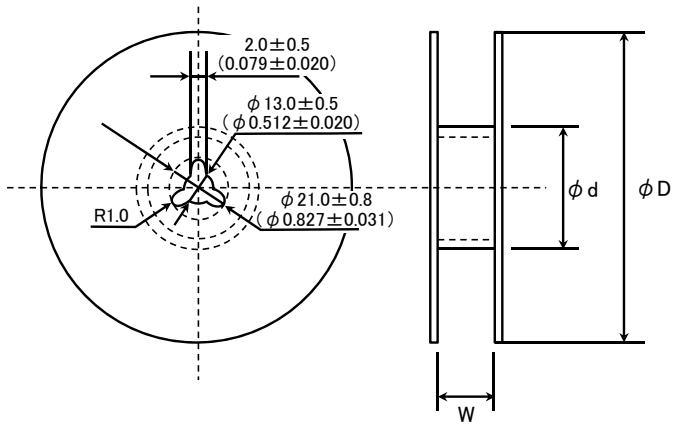

Type	ϕD	ϕd	W
BU05MC	330 ± 2.0 (12.99 \pm 0.079)	80 ± 1.0 (3.15 \pm 0.039)	13.5 ± 1.0 (0.53 \pm 0.039)

Unit : mm (inch)

⑥ Top Tape Strength

The top tape requires a peel-off force of 0.1 to 0.7N in the direction of the arrow as illustrated below.

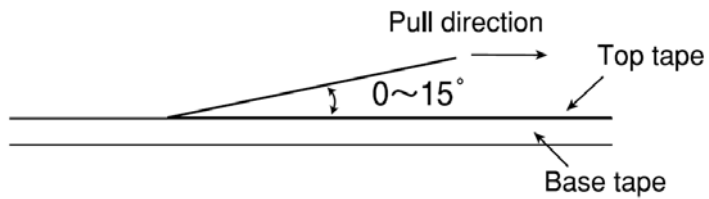

SMD COMMON MODE CHOKE COILS FOR DC AND SIGNAL LINES, BALUN TRANSFORMERS

PRECAUTIONS

1. Circuit Design

Precautions	<p>◆Operating environment</p> <p>1. The products described in this specification are intended for use in general electronic equipment, (office supply equipment, telecommunications systems, measuring equipment, and household equipment). They are not intended for use in mission-critical equipment or systems requiring special quality and high reliability (traffic systems, safety equipment, aerospace systems, nuclear control systems and medical equipment including life-support systems,) where product failure might result in loss of life, injury or damage. For such uses, contact TAIYO YUDEN Sales Department in advance.</p>
-------------	---

2. PCB Design

Precautions	<p>◆Land pattern design</p> <p>1. Please contact any of our offices for a land pattern, and refer to a recommended land pattern of specifications.</p>
Technical considerations	<p>◆Land pattern design</p> <p>Surface Mounting</p> <ul style="list-style-type: none"> • Mounting and soldering conditions should be checked beforehand. • Applicable soldering process to these products is reflow soldering only. • Recommended Land Patterns <p>【BU05MC】</p> <p style="text-align: right;">Unit: mm</p>

3. Considerations for automatic placement

Precautions	<p>◆Adjustment of mounting machine</p> <p>1. Excessive impact load should not be imposed on the products when mounting onto the PC boards.</p> <p>2. Mounting and soldering conditions should be checked beforehand.</p>
Technical considerations	<p>◆Adjustment of mounting machine</p> <p>1. When installing products, care should be taken not to apply distortion stress as it may deform the products.</p>

4. Soldering

Precautions	<p>◆Reflow soldering</p> <p>1. Please contact any of our offices for a reflow soldering, and refer to the recommended condition specified.</p> <p>2. This product can be used reflow soldering only.</p> <p>3. Please do not add any stress to a product until it returns in normal temperature after reflow soldering.</p> <p>◆Lead free soldering</p> <p>1. When using products with lead free soldering, we request to use them after confirming adhesion, temperature of resistance to soldering heat, soldering etc sufficiently.</p> <p>◆Recommended conditions for using a soldering iron</p> <p>【BU05MC】</p> <ul style="list-style-type: none"> • Put the soldering iron on the land-pattern. • Soldering iron's temperature - Below 350°C • Duration - 3 seconds or less • The soldering iron should not directly touch the inductor.
Technical considerations	<p>◆Reflow soldering</p> <p>1. If products are used beyond the range of the recommended conditions, heat stresses may deform the products, and consequently degrade the reliability of the products.</p> <p>◆Recommended conditions for using a soldering iron</p> <p>If products are used beyond the range of the recommended conditions, heat stresses may deform the products, and consequently degrade the reliability of the products.</p>

5. Cleaning

Precautions	<p>◆Cleaning conditions</p> <p>1. Please contact any of our offices for a cleaning.</p>
-------------	---

▶ This catalog contains the typical specification only due to the limitation of space. When you consider the purchase of our products, please check our specification. For details of each product (characteristics graph, reliability information, precautions for use, and so on), see our Web site (<http://www.ty-top.com/>).

6. Handling	
Precautions	<ul style="list-style-type: none"> ◆Handling <ol style="list-style-type: none"> 1. Keep the product away from all magnets and magnetic objects. ◆Breakaway PC boards (splitting along perforations) <ol style="list-style-type: none"> 1. When splitting the PC board after mounting product, care should be taken not to give any stresses of deflection or twisting to the board. 2. Board separation should not be done manually, but by using the appropriate devices. ◆Mechanical considerations <ol style="list-style-type: none"> 1. Please do not give the product any excessive mechanical shocks. 2. Please do not add any shock and power to a product in transportation. ◆Pick-up pressure <ol style="list-style-type: none"> 1. Please do not push to add any pressure to a winding part. Please do not give any shock and push onto an exposed part of ferrite cores. ◆Packing <ol style="list-style-type: none"> 1. Please avoid accumulation of a packing box as much as possible.
Technical considerations	<ul style="list-style-type: none"> ◆Handling <ol style="list-style-type: none"> 1. There is a case that a characteristic varies with magnetic influence. ◆Breakaway PC boards (splitting along perforations) <ol style="list-style-type: none"> 1. The position of the product on PCBs shall be carefully considered to minimize the stress caused from splitting of the PCBs. ◆Mechanical considerations <ol style="list-style-type: none"> 1. There is a case to be damaged by a mechanical shock. 2. There is a case to be broken by the handling in transportation. ◆Pick-up pressure <ol style="list-style-type: none"> 1. An excessive shock or stress may cause a damage to the product or a deterioration of a characteristic. ◆Packing <ol style="list-style-type: none"> 1. If packing boxes are accumulated, that could cause a deformation on packing tapes or a damage on the products.
7. Storage conditions	
Precautions	<ul style="list-style-type: none"> ◆Storage <ol style="list-style-type: none"> 1. To maintain the solderability of terminal electrodes and to keep the packing material in good condition, temperature and humidity in the storage area should be controlled. <ul style="list-style-type: none"> • Recommended conditions <ul style="list-style-type: none"> Ambient temperature : 0~40°C, Humidity : Below 70% RH <p>The ambient temperature must be kept below 30°C. Even under ideal storage conditions, the solderability of electrodes may decrease gradually. For this reason, the products should be used within one year from the time of delivery. In case of storage over 6 months, solderability shall be checked before actual usage.</p>
Technical considerations	<ul style="list-style-type: none"> ◆Storage <ol style="list-style-type: none"> 1. Under a high temperature and humidity environment, problems such as reduced solderability caused by oxidation of terminal electrodes and deterioration of taping/packaging materials may take place.