

ROHS Compliant



台灣駿品端子股份有限公司

TAIWAN KING PIN TERMINAL CO.,LTD

新北市樹林區俊德街 23 號

TEL:886-2-26895596.26886112

FAX:886-2-26886110

E-mail:info@tkp.com.tw

http://www.tkp.com.tw

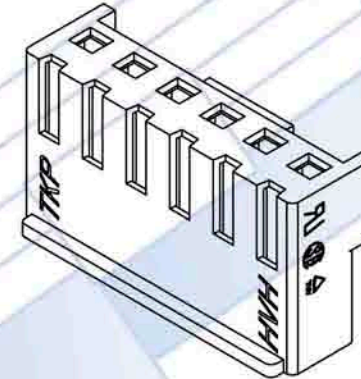
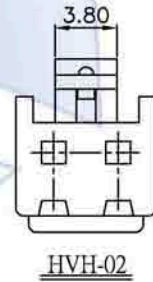
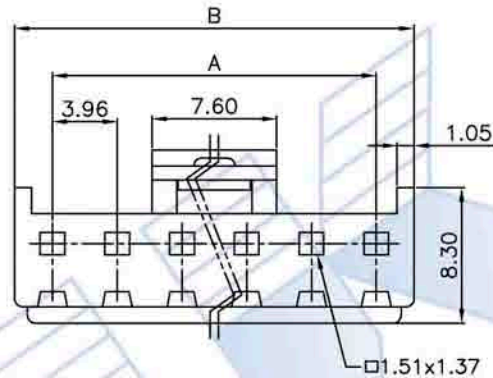

NOTE

- * Material : Nylon UL 94V-0 or UL 94V-2
- * Electrical rating : UL 250V 10A , AC/DC
CSA 250V 6A , AC/DC
TUV 250V 7A , AC/DC
- * Color: White / Black / Red
- * Accepts VHT(LF) terminal
- * Mates with PVHI,PVHLseries headers
- * 2-15 circuits available
- * For GWE Testing Approval Used

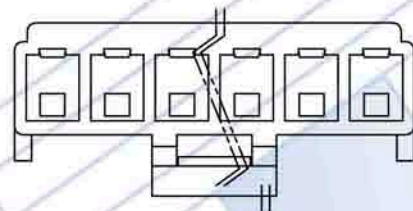
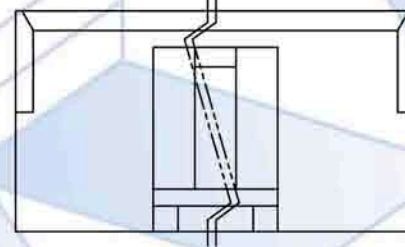
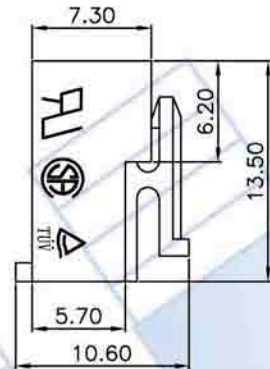
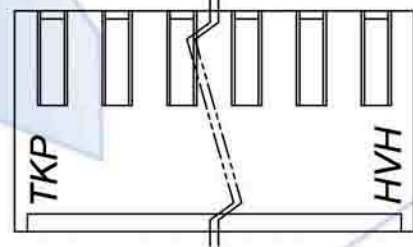
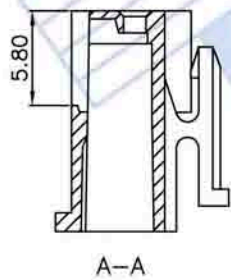

| Circuits | Part No. | Dim. A | Dim. B | Circuits | Part No. | Dim. A | Dim. B |
|----------|----------|--------|--------|----------|----------|--------|--------|
| 2 | HVH-02 | 3.96 | 8.60 | 9 | HVH-09 | 31.68 | 36.32 |
| 3 | HVH-03 | 7.92 | 12.56 | 10 | HVH-10 | 35.64 | 40.28 |
| 4 | HVH-04 | 11.88 | 16.52 | 11 | HVH-11 | 39.60 | 44.24 |
| 5 | HVH-05 | 15.84 | 20.48 | 12 | HVH-12 | 43.56 | 48.20 |
| 6 | HVH-06 | 19.80 | 24.44 | 13 | HVH-13 | 47.52 | 52.16 |
| 7 | HVH-07 | 23.76 | 28.40 | 14 | HVH-14 | 51.48 | 56.12 |
| 8 | HVH-08 | 27.72 | 32.36 | 15 | HVH-15 | 55.44 | 60.08 |

| PART NO. | HVH-XX | | | Part NO. | Material | Color/Finish | Remark | APPROVAL | |
|-------------|----------------------|---------|----------|--|----------------|--------------|--------------|---------------|--|
| TITLE | 3.96mm Wire to Board | | | HVH-XX | Nylon UL 94V-0 | White | Schulamid | DRAWN: 高琇瑩 | |
| | | | | HVH-XX-NF | Nylon UL 94V-2 | White | | | |
| | | | | HVH-XX-R | Nylon UL 94V-0 | Red | CHECKED: 張明遠 | | |
| THIRD ANGLE | SCALE | UNIT | SHEET NO | TOLERANCE | DATE | ODD NUMBERS | REV | APPROVED: 陳泓宇 | |
| | FREE | mm | 1/1 | .X± 0.30 .XXX±0.10 .XX± 0.20 ANGLE±2° | 2012.12.14 | ENG951549 | A5 | | |
| | | 396-003 | A396-001 | | | | | | |



1

2

3

4

5

6

7

8