

Rail-to-Rail Output, General Purpose Dual OPA, Low Voltage, Low Supply current

FEATURES

- CMOS rail to rail output
- 2.4 to 6.5V single supply operation
- Low supply current : 85uA (per channel at $V_{DD}=2.7V$)
- Gain-Bandwidth Product : 1MHz
- Slew rate : 1V/ μ s
- No crossover distortion
- Space saving package SOP8, MSOP8
- Cost effective
- Pin assignments is the same as the general-purpose dual operational amplifiers

APPLICATIONS

- Active filters
- Supply current monitoring
- Battery monitoring
- Voice preamplifier
- General purpose low voltage applications
- General purpose portable devices
- Cross-reference :
LMV358

DESCRIPTION

The MSV358 is the most cost-effective solutions for applications where low voltage operation. Each amplifier has low supply current of 100uA at 5V.

BLOCK DIAGRAM

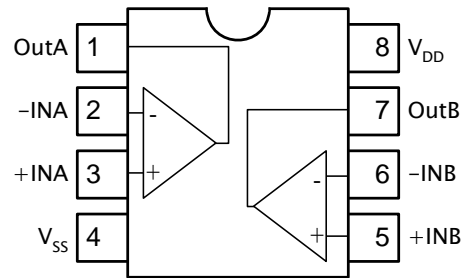

PIN CONFIGURATION

Symbol	Pin	Description
OUTA	1	Output A
-INA	2	Inverting input A
+INA	3	Non-inverting input A
V_{SS}	4	Negative supply
+INB	5	Non-inverting input B
-INB	6	Inverting input B
OUTB	7	Output B
V_{DD}	8	Positive supply

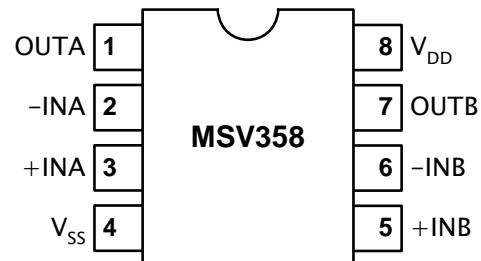

ORDERING INFORMATION

Package	Part number	Packaging Marking	Transport Media
8-Pin SOP (lead free)	MSV358GTR	MSV358G	2.5k Units Tape and Reel
8-Pin SOP (lead free)	MSV358GU	MSV358G	100 Units Tube
8-Pin MSOP (lead free)	MSV358MGTR	V358G	3.5k Units Tape and Reel
8-Pin MSOP (lead free)	MSV358MGU	V358G	80 Units Tube

RoHS Compliance

ABSOLUTE MAXIMUM RATINGS

Symbol	Parameter	Rating	Unit
V _{DD}	Supply Voltage	6.5	V
V _{ESD}	Electrostatic Handling	-2000 to 2000	V
T _{STG}	Storage Temperature Range	-65 to 150	°C
T _A	Operating Ambient Temperature Range	-40 to 85	°C
T _J	Maximum Junction Temperature	150	°C
T _S	Soldering Temperature, 10 seconds	260	°C
R _{THJA}	Thermal Resistance from Junction to Ambient in Free Air SOP8 MSOP8	175 235	°C/W

OPERATING RATINGS

Symbol	Parameter	Min	Typ	Max	Unit
V _{DD}	Supply Voltage	2.1	-	6.5	V

5V ELECTRICAL CHARACTERISTICS

(T_a=25°C, V_{DD}=5V, V_{SS}=0V, V_{CM}=V_O=V_{DD}/2; unless otherwise specified)

Symbol	Parameter	Conditions	Min	Typ	Max	Unit
DC Characteristics						
I _Q	Quiescent current	Dual Amplifiers	-	200	-	μA
V _{OS}	Input offset voltage		-	1	5	mV
CMRR	Common mode rejection ratio	0 ≤ V _{CM} ≤ 4V	60	70	-	dB
PSRR	Power supply rejection ratio	Ripple = -20dBV, 100Hz	-	65	-	dB
CS	Cannel separation	f = 10kHz	-	76	-	dB
V _{ICM}	Input common mode voltage range	CMRR ≥ 50dB	-0.2	-	4.2	V
V _O	Output voltage swing	R _L =100kΩ, A _v = -1 (THD+N) < -65dB	-	V _{DD} -10	V _{DD} -5	mV
AC Characteristics						
SR	Slew rate		-	1	-	V/μs
GBWP	Gain bandwidth product		-	1	-	MHz
THD+N	Total harmonic distortion plus noise	f = 1kHz, A _v = -1 R _L > 10k, V _{in} = 4V _{pp}	-	-75	-70	dB

2.7V ELECTRICAL CHARACTERISTICS

($T_a=25^\circ\text{C}$, $V_{DD}=2.7\text{V}$, $V_{SS}=0\text{V}$, $V_{CM}=V_O=V_{DD}/2$; unless otherwise specified)

Symbol	Parameter	Conditions	Min	Typ	Max	Unit
DC Characteristics						
I_Q	Quiescent current	Dual Amplifiers	-	170	-	μA
V_{OS}	Input offset voltage		-	1	5	mV
CMRR	Common mode rejection ratio	$0 \leq V_{CM} \leq 1.7\text{V}$	55	60	-	dB
PSRR	Power supply rejection ratio	Ripple = -20dBV, 100Hz	-	60	-	dB
CS	Cannel separation	$f = 10\text{kHz}$	-	76	-	dB
V_{ICM}	Input common mode voltage range	CMRR $\geq 50\text{dB}$	-0.2	-	1.9	V
V_O	Output voltage swing	$R_L=100\text{k}\Omega$, $A_v = -1$ (THD+N) < -65dB		$V_{DD}-25$	$V_{DD}-10$	mV
AC Characteristics						
GBWP	Gain bandwidth product		-	1	-	MHz
THD+N	Total harmonic distortion plus noise	$f = 1\text{kHz}$, $A_v = -1$ $R_L > 10\text{k}$, $V_{in} = 2V_{pp}$	-	-70	-65	dB

2.4V ELECTRICAL CHARACTERISTICS

($T_a=25^\circ\text{C}$, $V_{DD}=2.4\text{V}$, $V_{SS}=0\text{V}$, $V_{CM}=V_O=V_{DD}/2$; unless otherwise specified)

Symbol	Parameter	Conditions	Min	Typ	Max	Unit
DC Characteristics						
I_Q	Quiescent current	Dual Amplifiers	-	165	-	μA
V_{OS}	Input offset voltage		-	1	5	mV
CMRR	Common mode rejection ratio	$0 \leq V_{CM} \leq 1.4\text{V}$	51	56	-	dB
PSRR	Power supply rejection ratio	Ripple = -20dBV, 100Hz	-	55	-	dB
CS	Cannel separation	$f = 10\text{kHz}$	-	76	-	dB
V_{ICM}	Input common mode voltage range	CMRR $\geq 50\text{dB}$	-0.2	-	1.6	V
V_O	Output voltage swing	$R_L=100\text{k}\Omega$, $A_v = -1$ (THD+N) < -65dB		$V_{DD}-30$	$V_{DD}-15$	mV
AC Characteristics						
GBWP	Gain bandwidth product		-	1	-	MHz
THD+N	Total harmonic distortion plus noise	$f = 1\text{kHz}$, $A_v = -1$ $R_L > 10\text{k}$, $V_{in} = 2V_{pp}$	-	-69	-64	dB

TYPICAL PERFORMANCE CHARACTERISTICS

($T_a=25^\circ\text{C}$; unless otherwise specified)

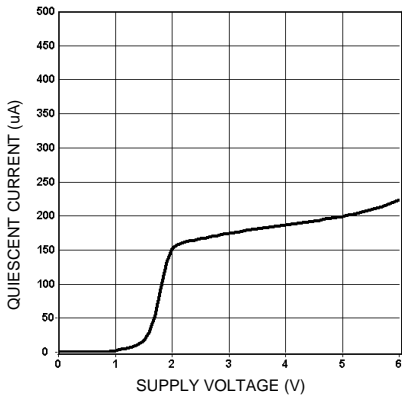

Quiescent current vs. supply voltage

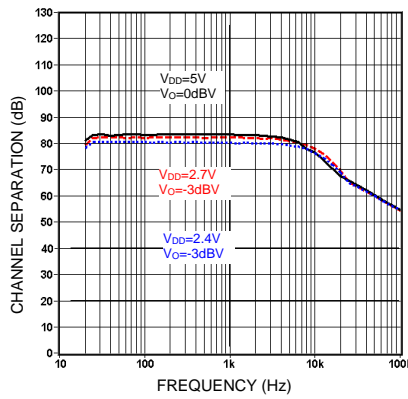

Channel separation vs. frequency

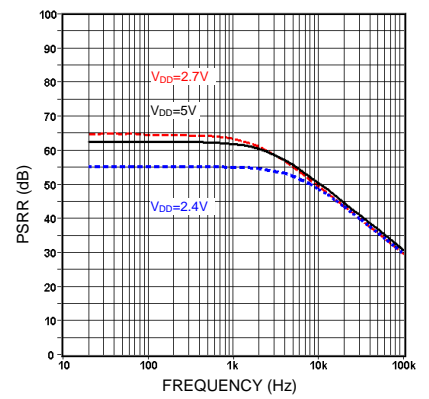

PSRR vs. frequency

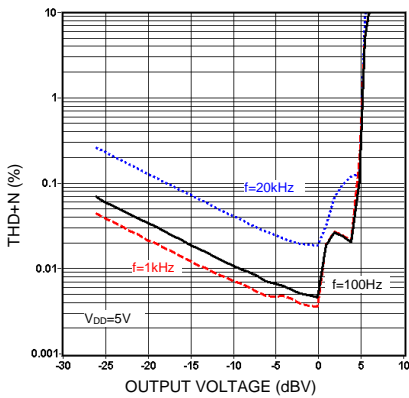

THD+N vs. output voltage

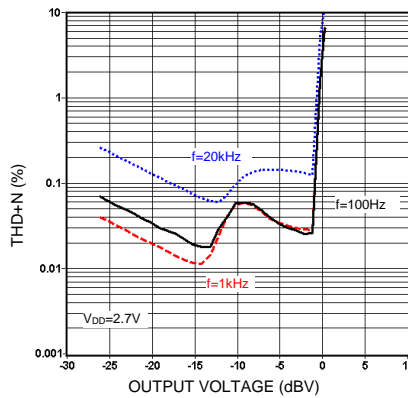

THD+N vs. output voltage

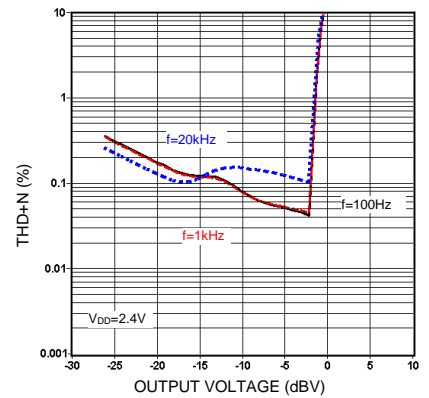

THD+N vs. output voltage

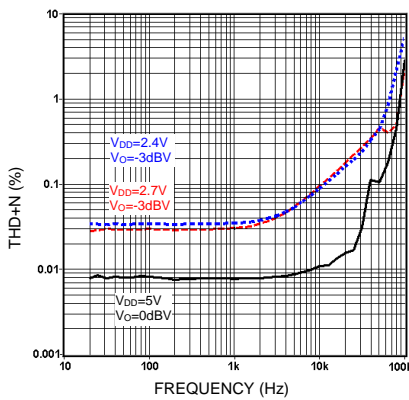

THD+N vs. frequency

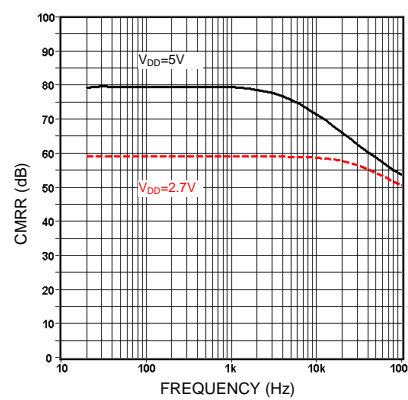

CMRR vs. frequency

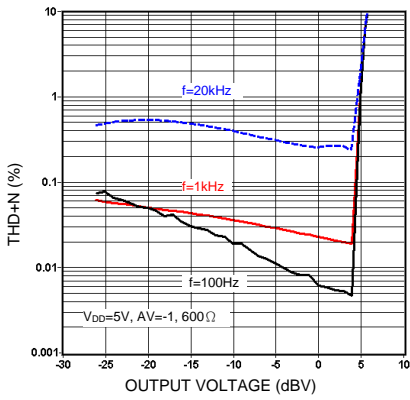

THD+N vs. output voltage

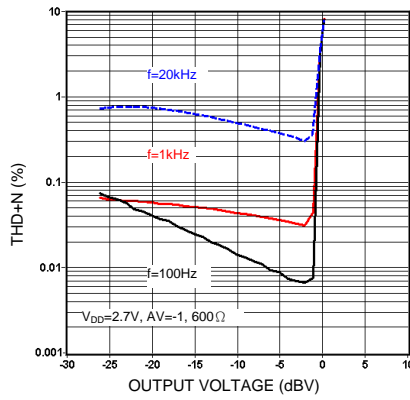

THD+N vs. output voltage

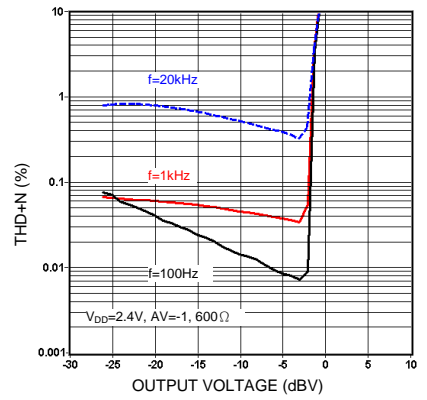

THD+N vs. output voltage

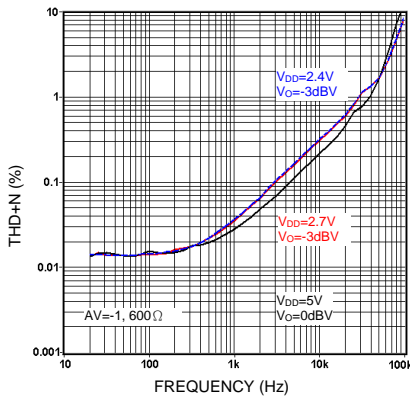

THD+N vs. frequency

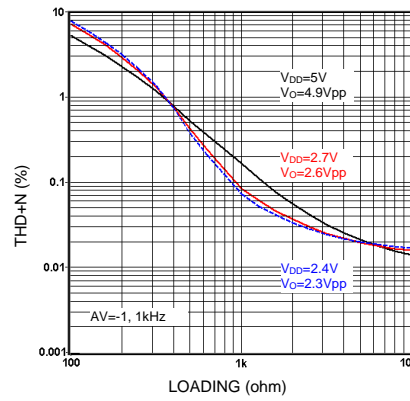

THD+N vs. R_L

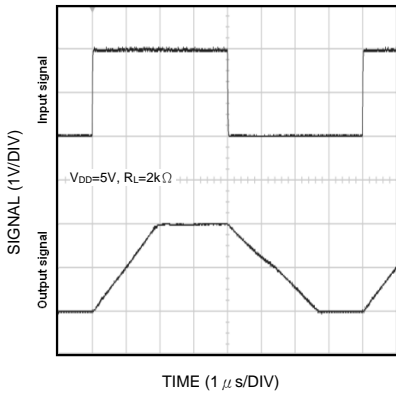

Non-inverting large signal pulse response

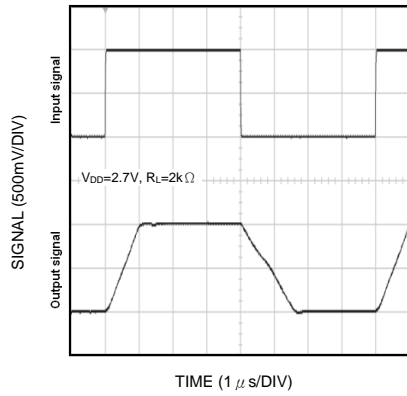

Non-inverting large signal pulse response

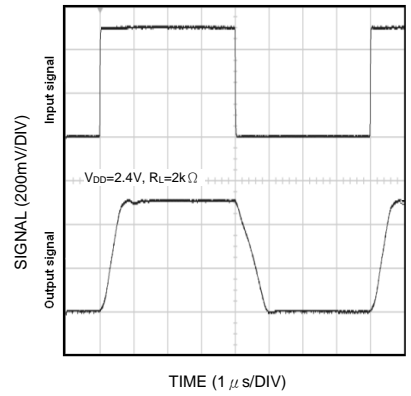

Non-inverting large signal pulse response

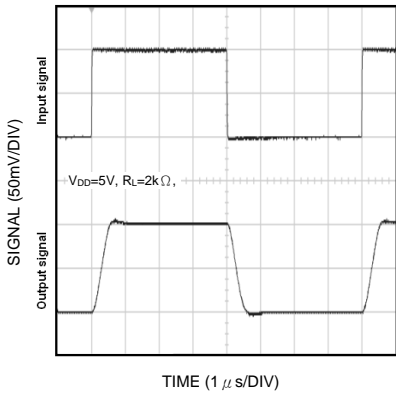

Non-inverting small signal pulse response

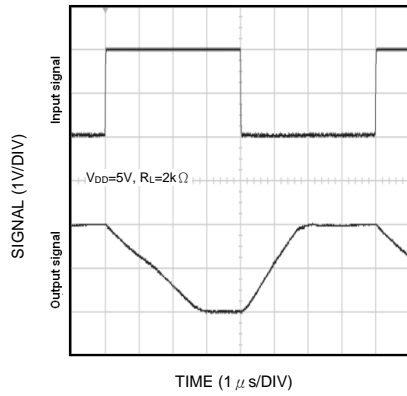

Inverting large signal pulse response

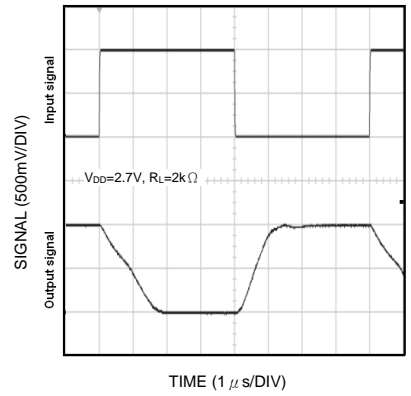

Inverting large signal pulse response

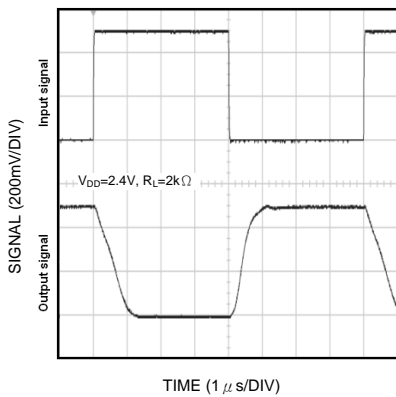

Inverting large signal pulse response

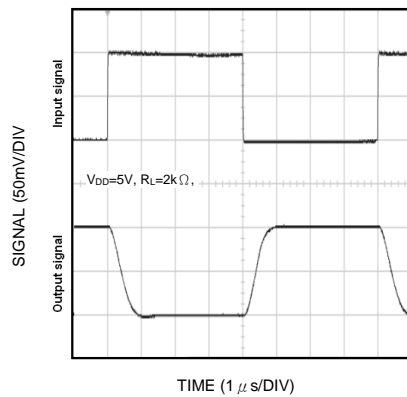

Inverting small signal pulse response

APPLICATION INFORMATION (Single Supply)

Voltage Follower

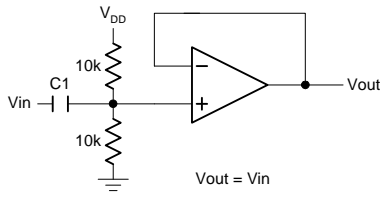

Difference Amplifier

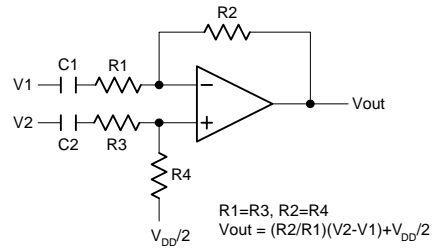

Inverting Amplifier

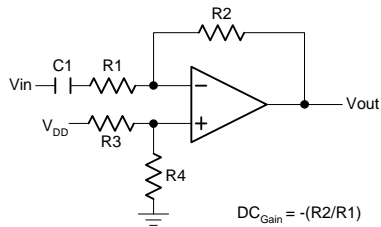

Simple High-Pass Filter

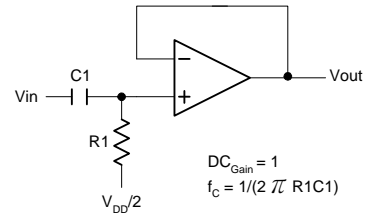

Simple Low-Pass Filter

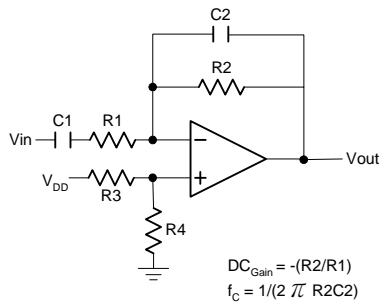

2nd Order Multiple Feedback Low-Pass Filter

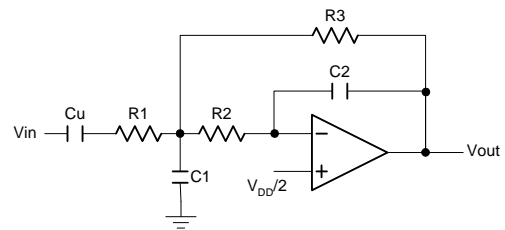

EXTERNAL DIMENSIONS

SOP8

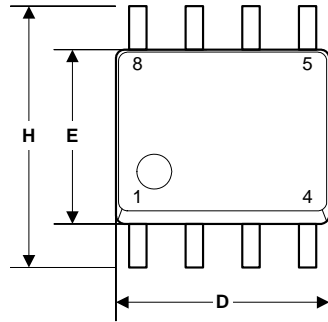

Symbol	Dimension in mm		Dimension in inch	
	Min	Max	Min	Max
A	1.35	1.75	0.0532	0.0688
A1	0.10	0.25	0.0040	0.0098
B	0.33	0.51	0.013	0.020
C	0.19	0.25	0.0075	0.0098
D	4.80	5.00	0.1890	0.1968
H	5.80	6.20	0.2284	0.2440
E	3.80	4.00	0.1497	0.1574
e	1.27 BSC		0.050 BSC	
L	0.40	1.27	0.016	0.050

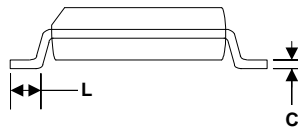
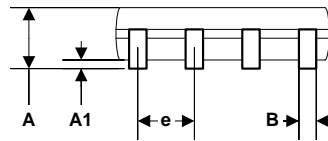

MSOP8

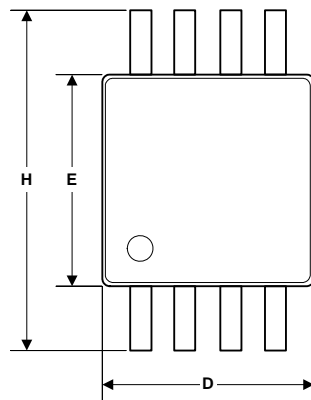

Symbol	Dimension in mm		Dimension in inch	
	Min	Max	Min	Max
A	0.81	1.12	0.032	0.048
A1	0.05	0.15	0.002	0.006
A2	0.76	0.86	0.030	0.038
B	0.28	0.38	0.011	0.015
C	0.13	0.23	0.005	0.009
D	2.90	3.10	0.114	0.122
H	4.70	5.10	0.185	0.201
E	2.90	3.10	0.114	0.122
e	0.65		0.026	
L	0.40	0.66	0.016	0.026

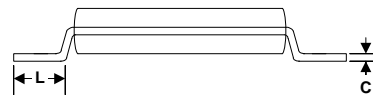
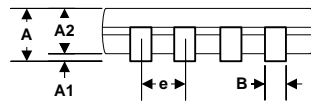

TAPE AND REEL (Unit : mm)

SOP8

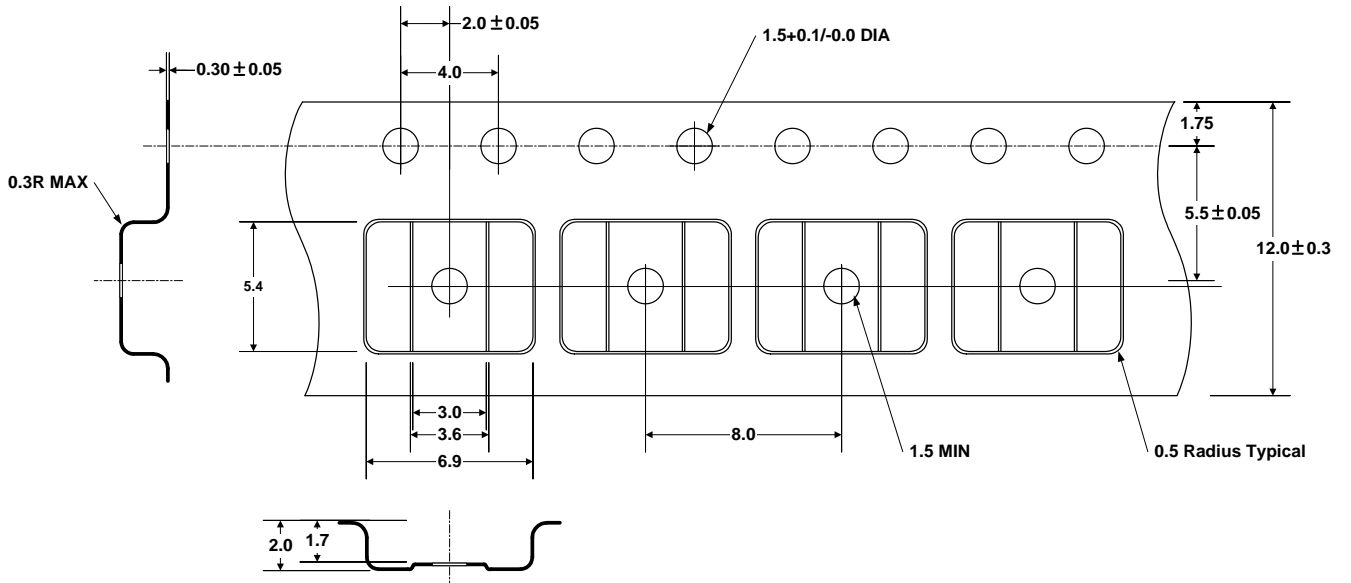

MSOP8

