

Silicon N Channel MOSFET Tetrode

BF 995

- For input and mixer stages in FM and VHF TV tuners

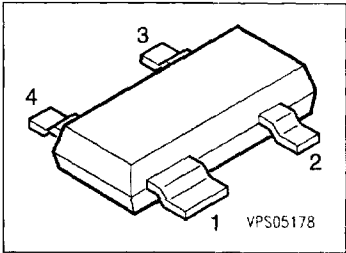

Type	Marking	Ordering Code (tape and reel)	Pin Configuration				Package ¹⁾
			1	2	3	4	
BF 995	MB	Q62702-F936	S	D	G ₂	G ₁	SOT-143

Maximum Ratings

Parameter	Symbol	Values	Unit
Drain-source voltage	V_{DS}	20	V
Drain current	I_D	30	mA
Gate 1/gate 2 peak source current	$\pm I_{G1/2SM}$	10	
Total power dissipation, $T_s < 76 \text{ }^\circ\text{C}$	P_{tot}	200	mW
Storage temperature range	T_{stg}	- 55 ... + 150	$^\circ\text{C}$
Channel temperature	T_{ch}	150	

Thermal Resistance

Junction - soldering point	$R_{th JS}$	< 370	K/W
----------------------------	-------------	-------	-----

¹⁾ For detailed information see chapter Package Outlines.

Electrical Characteristics

at $T_A = 25\text{ }^\circ\text{C}$, unless otherwise specified.

Parameter	Symbol	Values			Unit
		min.	typ.	max.	

DC Characteristics

Drain-source breakdown voltage $I_D = 10\text{ }\mu\text{A}$, $-V_{G1S} = -V_{G2S} = 4\text{ V}$	$V_{(BR)DS}$	20	–	–	V
Gate 1 source breakdown voltage $\pm I_{G1S} = 10\text{ mA}$, $V_{G2S} = V_{DS} = 0$	$\pm V_{(BR)G1SS}$	8.5	–	14	
Gate 2 source breakdown voltage $\pm I_{G2S} = 10\text{ mA}$, $V_{G1S} = V_{DS} = 0$	$\pm V_{(BR)G2SS}$	8.5	–	14	
Gate 1 source leakage current $\pm V_{G1S} = 5\text{ V}$, $V_{G2S} = V_{DS} = 0$	$\pm I_{G1SS}$	–	–	50	nA
Gate 2 source leakage current $\pm V_{G2S} = 5\text{ V}$, $V_{G1S} = V_{DS} = 0$	$\pm I_{G2SS}$	–	–	50	
Drain current $V_{DS} = 15\text{ V}$, $V_{G1S} = 0$, $V_{G2S} = 4\text{ V}$	I_{DSS}	4	–	20	mA
Gate 1 source pinch-off voltage $V_{DS} = 15\text{ V}$, $V_{G2S} = 4\text{ V}$, $I_D = 20\text{ }\mu\text{A}$	$-V_{G1S(p)}$	–	–	2.5	V
Gate 2 source pinch-off voltage $V_{DS} = 15\text{ V}$, $V_{G1S} = 0$, $I_D = 20\text{ }\mu\text{A}$	$-V_{G2S(p)}$	–	–	2.0	

Electrical Characteristics

at $T_A = 25\text{ }^\circ\text{C}$, unless otherwise specified.

Parameter	Symbol	Values			Unit
		min.	typ.	max.	

AC Characteristics

Forward transconductance $V_{DS} = 15\text{ V}$, $I_D = 10\text{ mA}$, $V_{G2S} = 4\text{ V}$, $f = 1\text{ kHz}$	g_{fs}	12	17	–	mS
Gate 1 input capacitance $V_{DS} = 15\text{ V}$, $I_D = 10\text{ mA}$, $V_{G2S} = 4\text{ V}$, $f = 1\text{ MHz}$	C_{g1ss}	–	3.6	–	pF
Gate 2 input capacitance $V_{DS} = 15\text{ V}$, $I_D = 10\text{ mA}$, $V_{G2S} = 4\text{ V}$, $f = 1\text{ MHz}$	C_{g2ss}	–	1.6	–	
Feedback capacitance $V_{DS} = 15\text{ V}$, $I_D = 10\text{ mA}$, $V_{G2S} = 4\text{ V}$, $f = 1\text{ MHz}$	C_{dg1}	–	25	–	fF
Output capacitance $V_{DS} = 15\text{ V}$, $I_D = 10\text{ mA}$, $V_{G2S} = 4\text{ V}$, $f = 1\text{ MHz}$	C_{dss}	–	1.6	–	pF
Power gain $V_{DS} = 15\text{ V}$, $I_D = 10\text{ mA}$ $f = 200\text{ MHz}$, $G_G = 2\text{ mS}$, $G_L = 0.5\text{ mS}$ $2\Delta f = 12\text{ MHz}$ (see test circuit 1)	G_{ps}	–	23	–	dB
Noise figure $V_{DS} = 15\text{ V}$, $I_D = 10\text{ mA}$ $f = 200\text{ MHz}$, $G_G = 2\text{ mS}$, $G_L = 0.5\text{ mS}$ (see test circuit 1)	F	–	1.1	–	
Gain control range $V_{DS} = 15\text{ V}$, $V_{G2S} = 4 \dots - 2\text{ V}$, $f = 200\text{ MHz}$ (see test circuit 1)	ΔG_{ps}	–	50	–	
Mixer gain (additive) $V_{DS} = 15\text{ V}$, $V_{G2S} = 6\text{ V}$, $R_S = 220\ \Omega$ $f = 200\text{ MHz}$, $f_F = 36\text{ MHz}$ $2\Delta f = 5\text{ MHz}$, $V_{osc} = 0.5\text{ V}$ (see test circuit 2)	G_{psc}	–	16	–	
Mixer gain (multiplicative) $V_{DS} = 15\text{ V}$, $V_{G1S} = 1.7\text{ V}$, $V_{G2S} = 2.5\text{ V}$ $R_S = 220\ \Omega$, $f = 200\text{ MHz}$, $f_F = 36\text{ MHz}$ $2\Delta f = 5\text{ MHz}$, $V_{osc} = 2\text{ V}$ (see test circuit 3)	G_{psc}	–	18	–	

Total power dissipation $P_{tot} = f(T_A)$

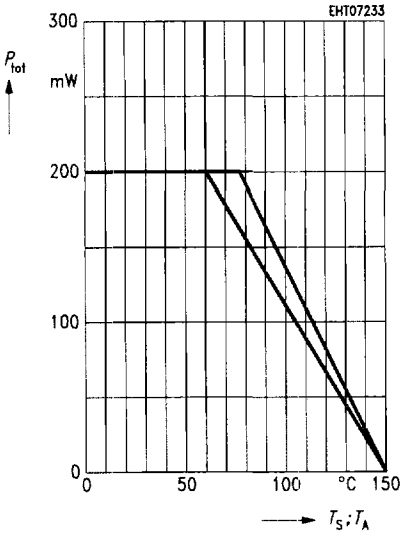

Output characteristics $I_D = f(V_{DS})$

$V_{GS} = 4 V$

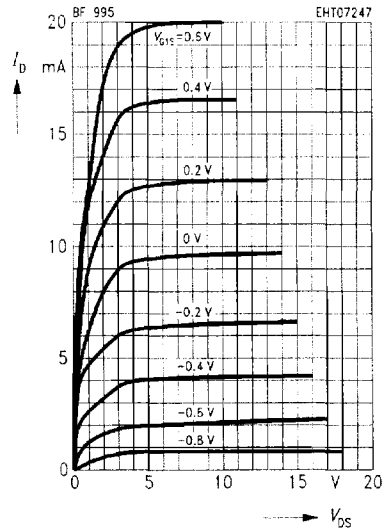

Gate 1 forward transconductance $g_{fs1} = f(V_{G1S})$

$g_{fs1} = f(V_{G1S})$

$V_{DS} = 15 V, I_{DSS} = 10 mA, f = 1 kHz$

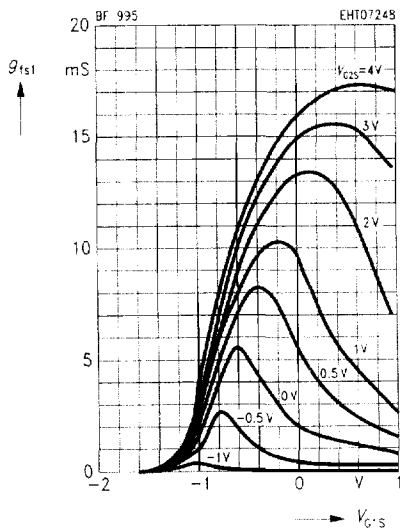

Gate 1 forward transconductance $g_{fs1} = f(V_{G2S})$

$g_{fs1} = f(V_{G2S})$

$V_{DS} = 15 V, I_{DSS} = 10 mA, f = 1 kHz$

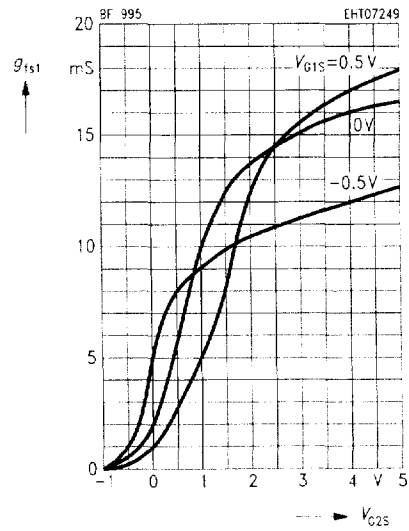

Drain current $I_D = f(V_{G1S})$

$V_{DS} = 15 \text{ V}$

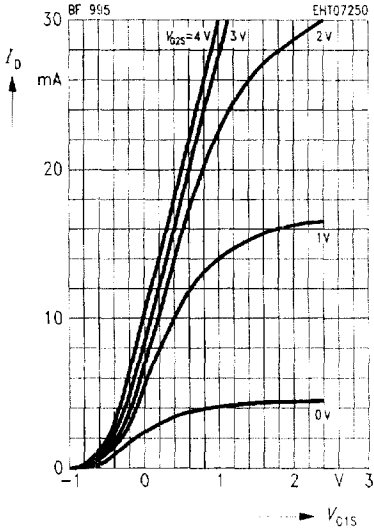

Gate 1 input capacitance $C_{G1SS} = f(V_{G1S})$

$V_{G2S} = 4 \text{ V}$, $V_{DS} = 15 \text{ V}$

$I_{DSS} = 10 \text{ mA}$, $f = 1 \text{ MHz}$

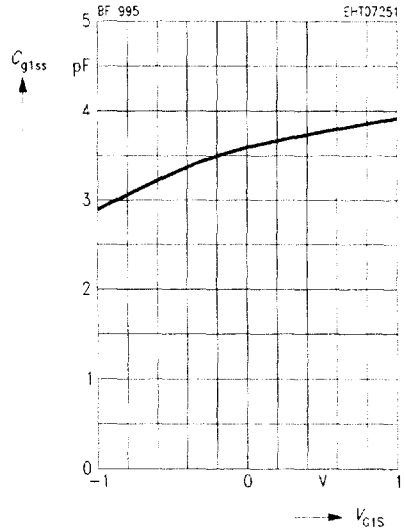

Gate 2 input capacitance $C_{G2SS} = f(V_{G2S})$

$V_{G1S} = 0 \text{ V}$, $V_{DS} = 15 \text{ V}$

$I_{DSS} = 10 \text{ mA}$, $f = 1 \text{ MHz}$

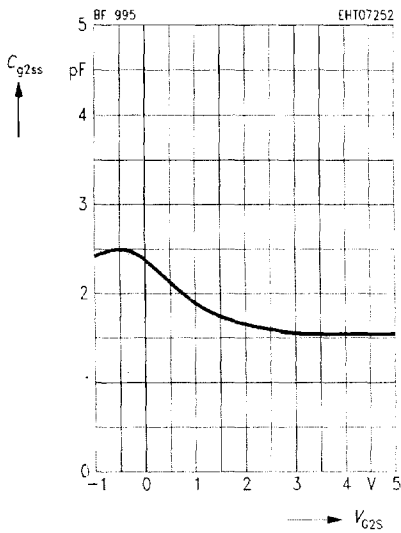

Output capacitance $C_{DSS} = f(V_{DS})$

$V_{G1S} = 0 \text{ V}$, $V_{G2S} = 4 \text{ V}$

$I_{DSS} = 10 \text{ mA}$, $f = 1 \text{ MHz}$

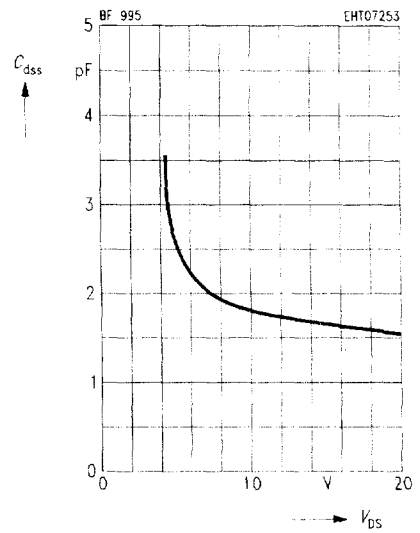

Gate 1 input admittance y_{11s}

$V_{DS} = 15 \text{ V}$, $V_{G2S} = 4 \text{ V}$
(common source)

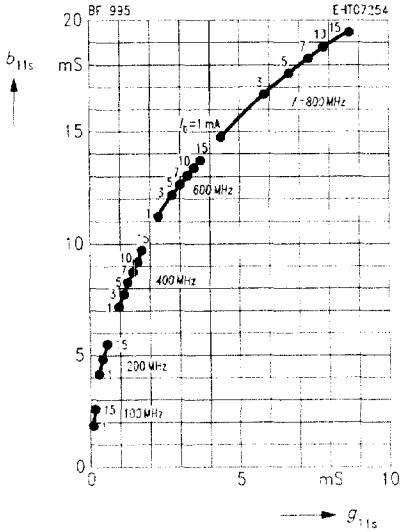

Gate 1 forward transfer admittance y_{21s}

$V_{DS} = 15 \text{ V}$, $V_{G2S} = 4 \text{ V}$
(common source)

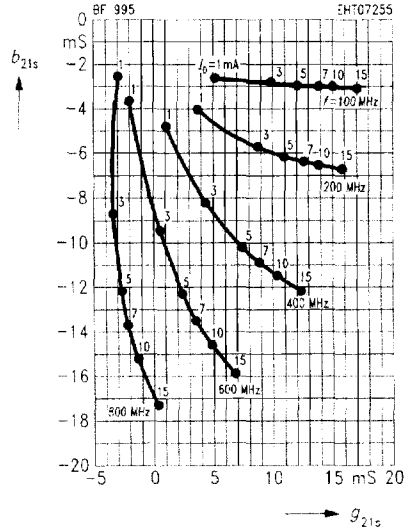

Output admittance y_{22s}

$V_{DS} = 15 \text{ V}$, $V_{G2S} = 4 \text{ V}$
(common source)

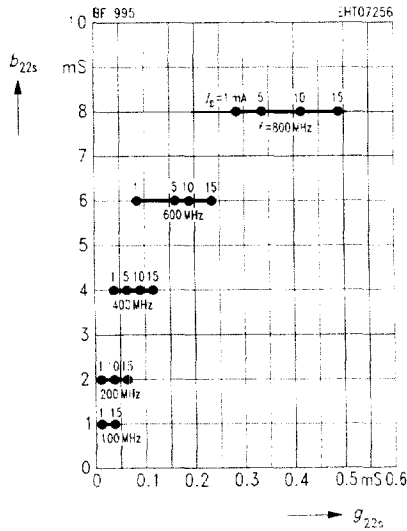

Power gain $G_{ps} = f(V_{G2s})$

$V_{DS} = 15\text{ V}$, $V_{G1s} = 0\text{ V}$, $I_{DSS} = 10\text{ mA}$
 $f = 200\text{ MHz}$ (see test circuit 1)

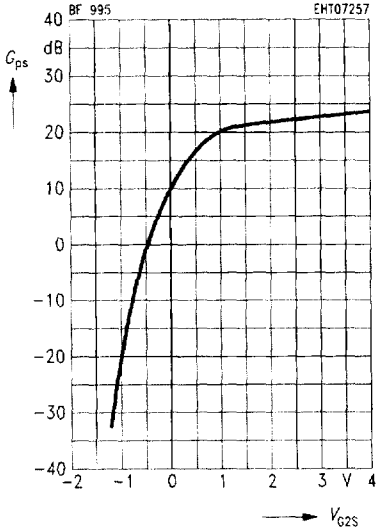

Noise figure $F = f(V_{G2s})$

$V_{DS} = 15\text{ V}$, $V_{G1s} = 0\text{ V}$, $I_{DSS} = 10\text{ mA}$
 $f = 200\text{ MHz}$ (see test circuit 1)

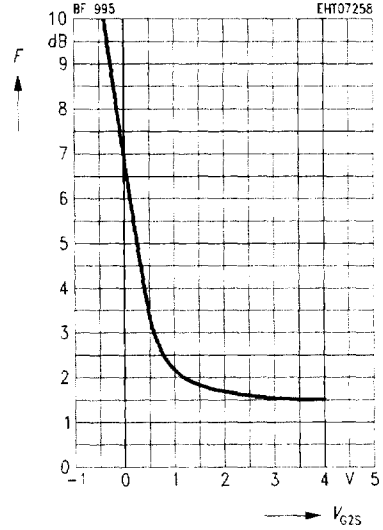

Interference voltage for 1% cross modulation $V_{int(1\%)} = f(\Delta G_{ps})^{(1)}$

$V_{DS} = 15\text{ V}$, $V_{G1s} = 0$, $f = 200\text{ MHz}$
 $f_{int} = 221\text{ MHz}$ (see test circuit 1)

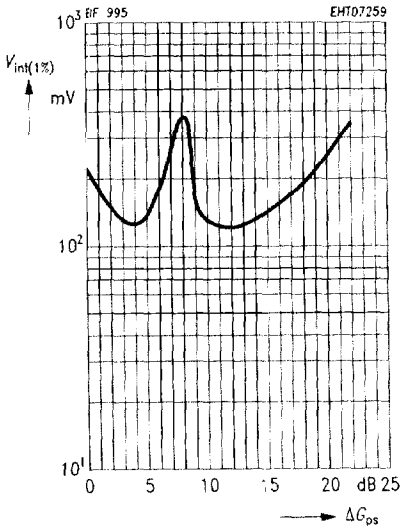

Interference voltage for 1% cross modulation $V_{int(1\%)} = f(f_{int})^{(1)}$

$V_{DS} = 15\text{ V}$, $V_{G2s} = 4\text{ V}$, $V_{G1s} = 0$
 $f = 200\text{ MHz}$ (see test circuit 1)

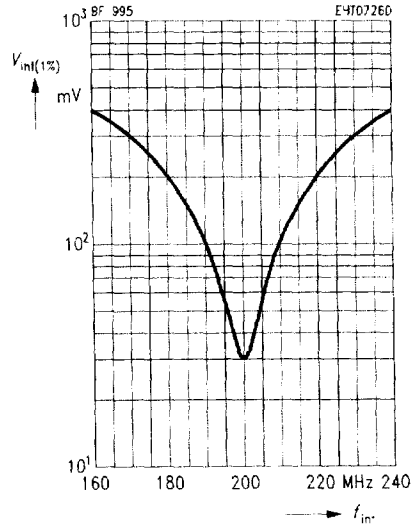

1) For footnote refer to the last page of this data sheet.

Mixer gain (additive) $G_{psc} = f(V_{osc})$

$V_D = 15\text{ V}$, $V_{G1S} = 0$, $V_{G2S} = 6\text{ V}$
 $R_S = 220\ \Omega$, $I_{DSS} = 10\text{ mA}$, $f = 200\text{ MHz}$
 $f_{IF} = 36\text{ MHz}$ (see test circuit 2)

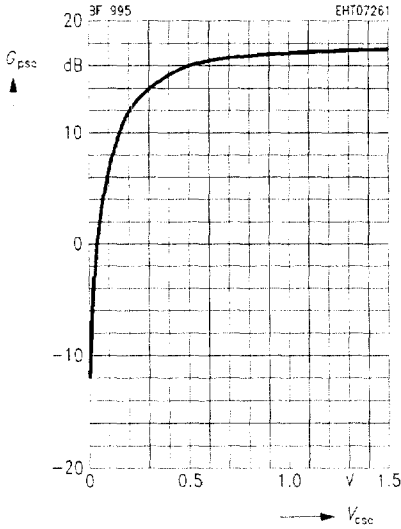

Mixer gain (additive) $G_{psc} = f(V_{G2S})$

$V_D = 15\text{ V}$, $V_{G1S} = 0$, $R_S = 220\ \Omega$
 $V_{osc} = 0.5\text{ V}$, $I_{DSS} = 10\text{ mA}$, $f = 200\text{ MHz}$
 $f_{IF} = 36\text{ MHz}$ (see test circuit 2)

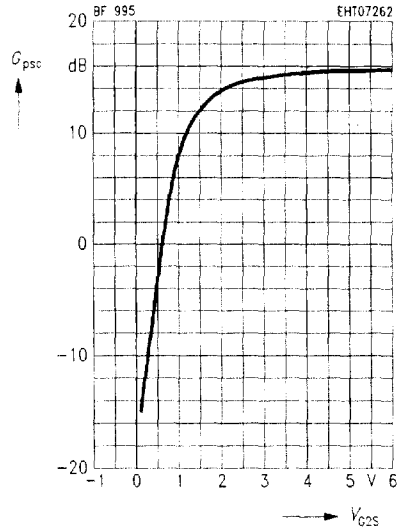

Mixer gain (additive) $G_{psc} = f(R_S)$

$V_D = 15\text{ V}$, $V_{G1S} = 0$, $V_{G2S} = 6\text{ V}$
 $V_{osc} = 0.5\text{ V}$, $f = 200\text{ MHz}$
 $f_{IF} = 36\text{ MHz}$ (see test circuit 2)

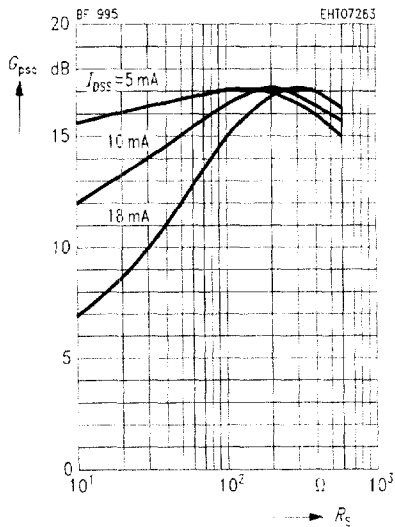

Mixer gain (multiplicative) $G_{psc} = f(V_{G2S})$

$V_D = 15\text{ V}$, $V_{G1S} = 1.7\text{ V}$, $R_S = 200\ \Omega$
 $I_{DSS} = 10\text{ mA}$, $f = 200\text{ MHz}$
 $f_{IF} = 36\text{ MHz}$ (see test circuit 3)

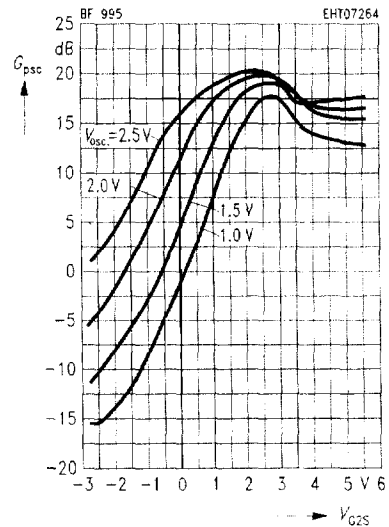

Test circuit 1 for power gain, noise figure and cross modulation

$f = 200 \text{ MHz}$, $G_G = 2 \text{ mS}$, $G_L = 0.5 \text{ mS}$

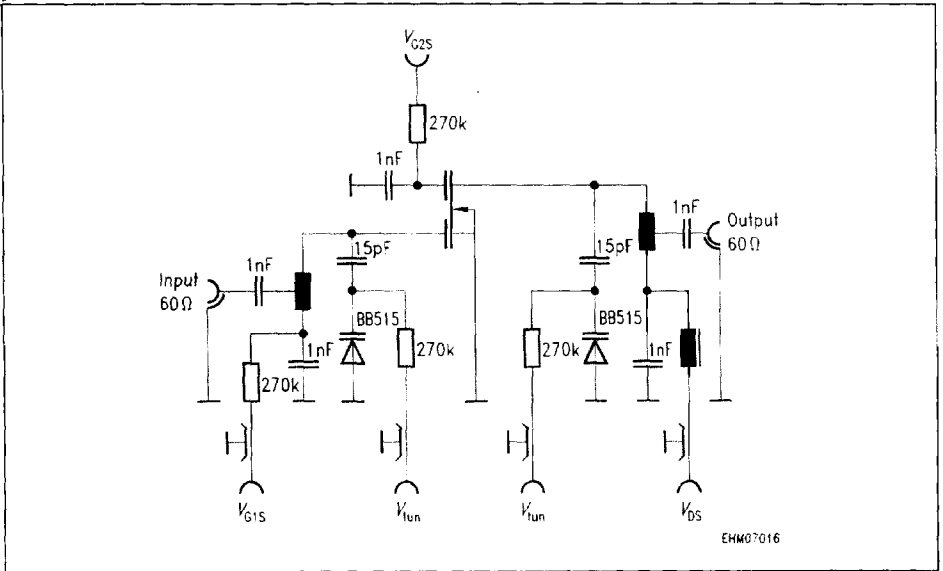

Test circuit 2 for mixer gain (additive)

$f = 200 \text{ MHz}$, $f_{osc} = 236 \text{ MHz}$, $2\Delta f_F = 5 \text{ MHz}$

