

G6121

Easy-to-use detector module with built-in preamp

This infrared detector module contains a preamp and operates by just connecting to a DC power supply. Thermoelectrically cooled types are also available. Besides these detectors, we welcome requests for custom devices that suit your application.

Features

- **Compact size**
- **Easy-to-use**
Operates just by connecting to DC power supply
- **Circuit design optimized for detector element characteristics**

Applications

- **Infrared detection**

Accessories

- **4-conductor cable for non-cooled type (for connection to DC power supply): 2 m (connector installed on one end) A4372-02**
- **Instruction manual**

Structure

Parameter	Min.	Typ.	Max.	Unit
Detector	InGaAs (G8370-05)			-
Window	AR coated (optimized for 1.55 μm peak) borosilicate glass			-
Photosensitive area size	φ5			mm
External input voltage	-	±15	±15.5	V

Absolute maximum ratings

Parameter	Symbol	Condition	Value	Unit
Incident light level	-	CW light, per 1 element	10	μW
Operating temperature	Topr		0 to +40	°C
Storage temperature	Tstg		-20 to +50	°C

Note: Exceeding the absolute maximum ratings even momentarily may cause a drop in product quality. Always be sure to use the product within the absolute maximum ratings.

Electrical and optical characteristics

Parameter	Symbol	Condition	Min.	Typ.	Max.	Unit
Element temperature (measurement condition)	Td		-	25	-	°C
Peak sensitivity wavelength	λp		-	1.55	-	μm
Cutoff wavelength	λc		-	1.7	-	μm
Photosensitivity	S	λ=λp, f=100 Hz	6.6 × 10 ⁵	1 × 10 ⁶	-	V/W
Noise equivalent power	NEP	*	-	5.0 × 10 ⁻¹³	3 × 10 ⁻¹²	W/Hz ^{1/2}
Cutoff frequency	fc	-3 dB	DC	-	8	kHz
Output impedance	-		-	50	-	Ω
Maximum output voltage	-	RL=1 kΩ	-	±10	-	V
Output offset voltage	-		-	±10	-	mV
Current consumption	Ic	*	-	±7	±15	mA

* Recommended DC power supply (analog power supply): ±15 V
Current capacity: More than 1.5 times the maximum current consumption
Ripple noise: 5 mVp-p or less

Spectral response

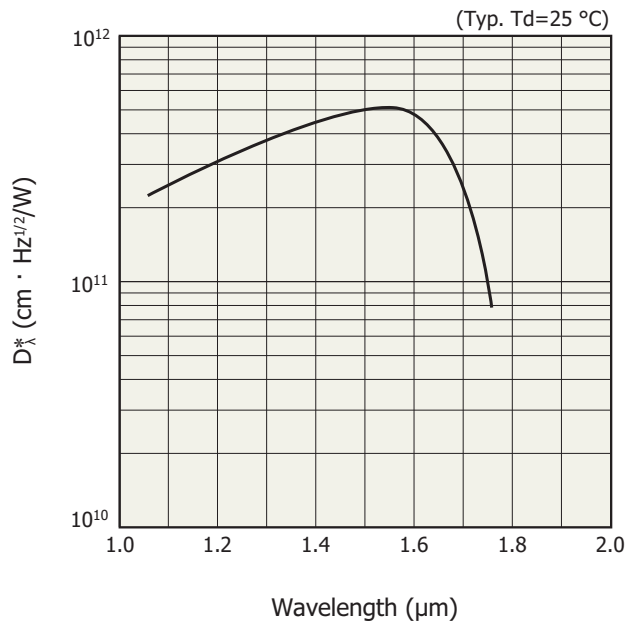

KIRD0532EA

Spectral transmittance characteristics of window material

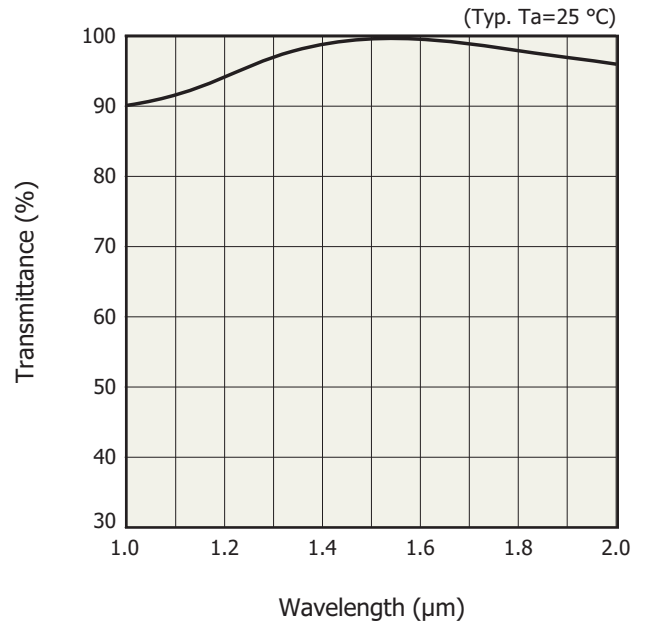

KIRD0526EA

Linearity

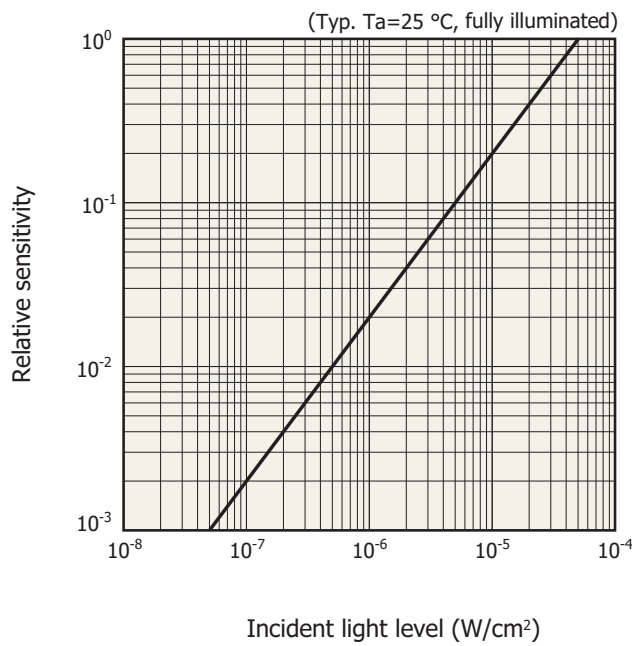

KIRD0515EA

Frequency response

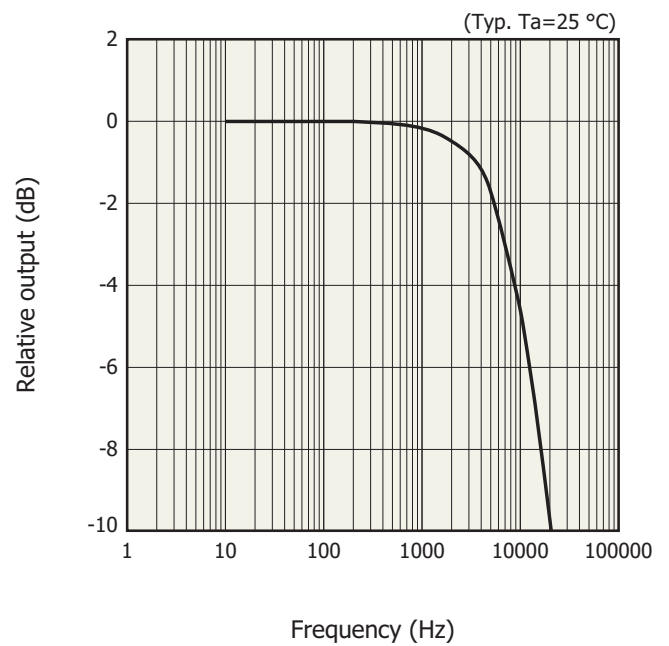

KIRD0518EA

❑ Noise equivalent power vs. frequency

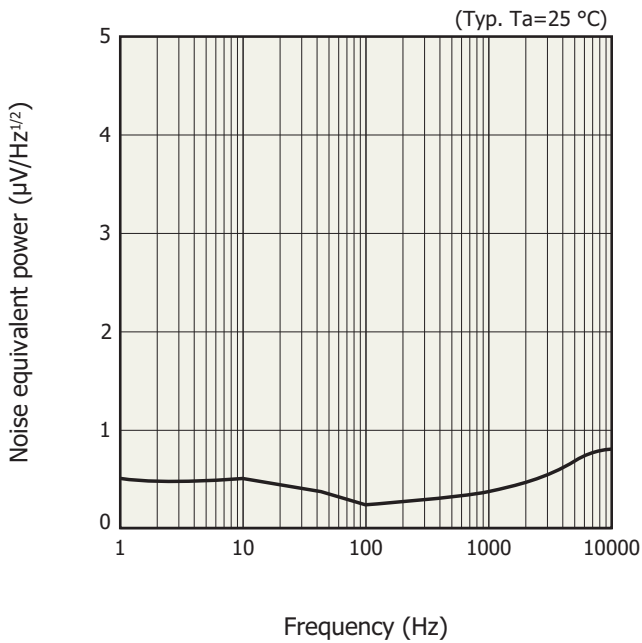

KIRDB0519EA

❑ Dimensional outline (unit: mm)

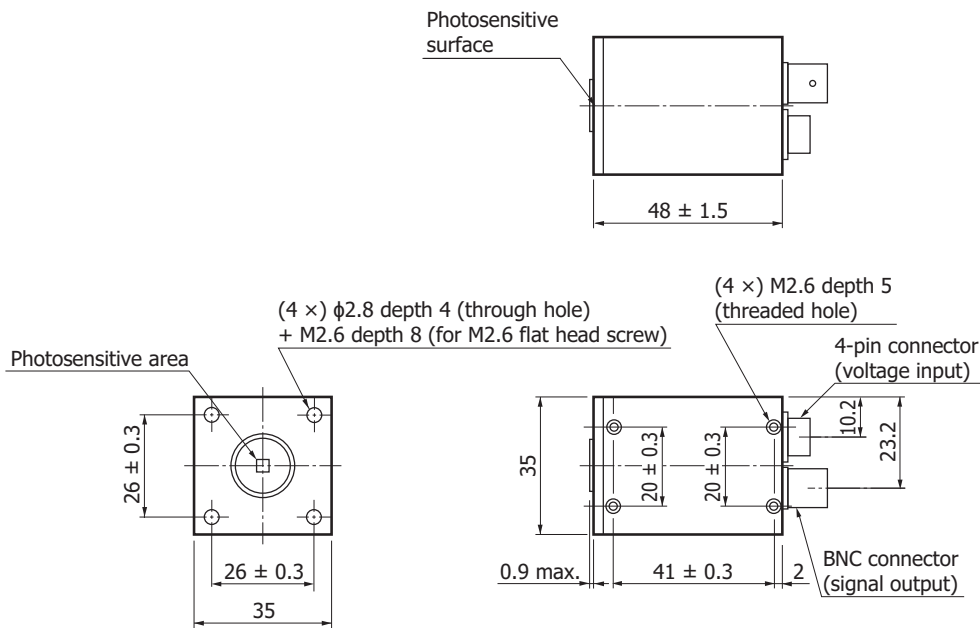

Pin no.	Pin connection	Color of cable lead (supplied)
①	+15 V	White
②	GND	Black, white, blue stranded wire
③	GND	
④	-15 V	Blue

Plug (figure from connection side)

Tolerance unless otherwise noted: ± 1

KIRDA0008EF

Cable A4372-02

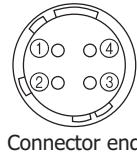
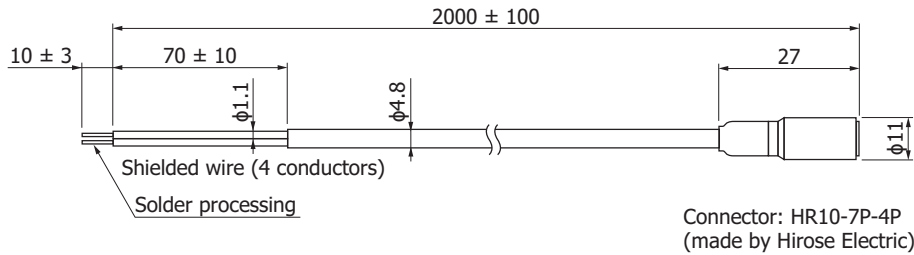

Connector end

Pin no.	Pin connection	Lead color
①	+15 V	White
②	GND	Black/white/blue stranded wire
③	GND	
④	-15 V	Blue

Tolerance unless otherwise noted: ±1

KIRDA0196EE

Precautions

- Always use a dual-polarity (±15 V) power supply to operate this detector. Never use a single-polarity (+15 V or -15 V only) power supply. Using a single-polarity power supply may cause the amplifier in the detector module to break down.
- Be careful not to apply excessive force to the detector surface. Applying excessive force may damage the light input window. Do not directly touch the light input window with bare hands. If dust or dirt gets on the window, wipe it gently using ethyl alcohol.
- Do not drop this product or do not apply excessive shock to it.

Related information

http://www.hamamatsu.com/sp/ssd/doc_en.html

Precautions

- Disclaimer

Technical information

- Infrared detectors

Information described in this material is current as of November, 2015.

Product specifications are subject to change without prior notice due to improvements or other reasons. This document has been carefully prepared and the information contained is believed to be accurate. In rare cases, however, there may be inaccuracies such as text errors. Before using these products, always contact us for the delivery specification sheet to check the latest specifications.

The product warranty is valid for one year after delivery and is limited to product repair or replacement for defects discovered and reported to us within that one year period. However, even if within the warranty period we accept absolutely no liability for any loss caused by natural disasters or improper product use. Copying or reprinting the contents described in this material in whole or in part is prohibited without our prior permission.

HAMAMATSU

www.hamamatsu.com

HAMAMATSU PHOTONICS K.K., Solid State Division

1126-1 Ichino-cho, Higashi-ku, Hamamatsu City, 435-8558 Japan, Telephone: (81) 53-434-3311, Fax: (81) 53-434-5184

U.S.A.: Hamamatsu Corporation: 360 Foothill Road, Bridgewater, N.J. 08807, U.S.A., Telephone: (1) 908-231-0960, Fax: (1) 908-231-1218

Germany: Hamamatsu Photonics Deutschland GmbH: Arzbergerstr. 10, D-82211 Herrsching am Ammersee, Germany, Telephone: (49) 8152-375-0, Fax: (49) 8152-265-8

France: Hamamatsu Photonics France S.A.R.L.: 19, Rue du Saule Trapu, Parc du Moulin de Massy, 91882 Massy Cedex, France, Telephone: 33-(1) 69 53 71 00, Fax: 33-(1) 69 53 71 10

United Kingdom: Hamamatsu Photonics UK Limited: 2 Howard Court, 10 Tewin Road, Welwyn Garden City, Hertfordshire AL7 1BW, United Kingdom, Telephone: (44) 1707-294888, Fax: (44) 1707-325777

North Europe: Hamamatsu Photonics Norden AB: Torshammsgatan 35 16440 Kista, Sweden, Telephone: (46) 8-509-031-00, Fax: (46) 8-509-031-01

Italy: Hamamatsu Photonics Italia S.r.l.: Strada della Moia, 1 int. 6, 20020 Arese (Milano), Italy, Telephone: (39) 02-93581733, Fax: (39) 02-93581741

China: Hamamatsu Photonics (China) Co., Ltd.: B1201, Jiaming Center, No.27 Dongsanhuan Beilu, Chaoyang District, Beijing 100020, China, Telephone: (86) 10-6586-6006, Fax: (86) 10-6586-2866