

Featuring Twist Pin,
Pin and Socket Contacts

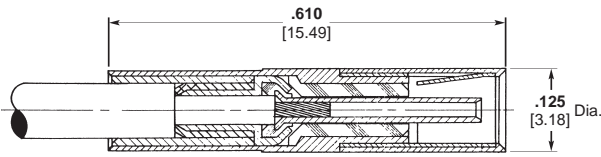

LEPRA/CON Slide-On Connectors offer a convenient mating style along with Ultra-miniature size. Inner contacts are twist pin tubular sockets in plugs and twist pin contacts for jacks and receptacles. Positive housing contact is provided by a three finger contact in the plug housing.



Straight Plug¹
Part Number 142-1000-0001
Instruction Sheet Number 408-08512
Former MICRODOT I.S. Number RF-ASMB-15

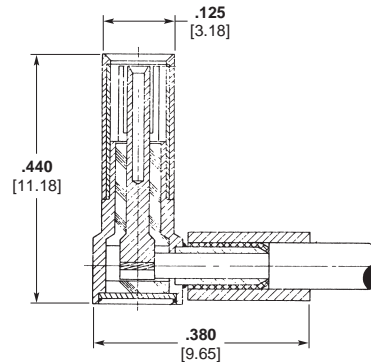
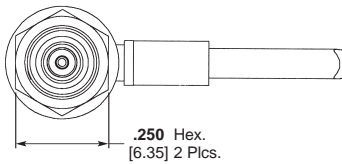

Right-Angle Plug¹
Part Number 142-1002-0001
Instruction Sheet Number 408-08513
Former MICRODOT I.S. Number RF-ASMB-16

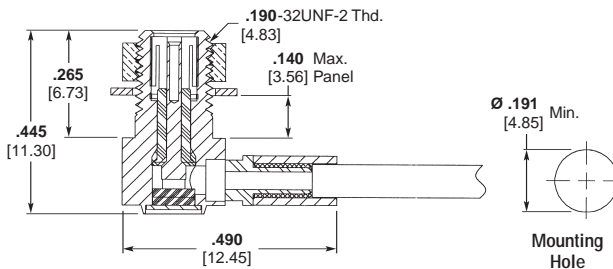

Right-Angle Bulkhead Mount Plug¹
Part Number 142-1021-0001
Instruction Sheet Number 408-08519
Former MICRODOT I.S. Number RF-ASMB-76

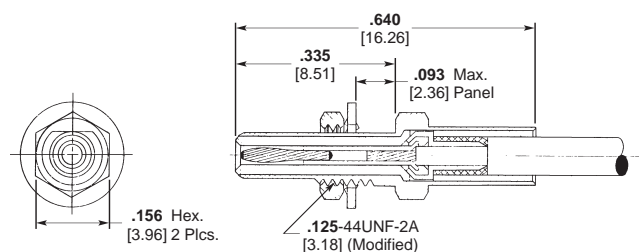

Straight Bulkhead Jack¹
Part Number 141-1001-0001
Instruction Sheet Number 408-08512
Former MICRODOT I.S. Number RF-ASMB-15

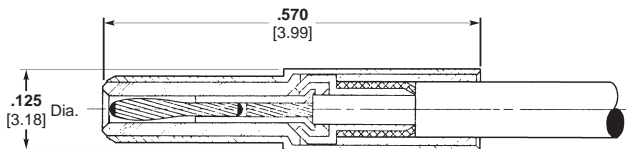

Straight Jack¹
Part Number 141-1000-0001
Instruction Sheet Number 408-08512
Former MICRODOT I.S. Number RF-ASMB-15

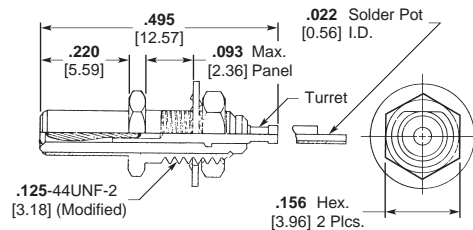

Front Mount Receptacle¹

Part No.	Contact Tail
141-1002-0001	Turret
141-1002-0002	Solder Pot

¹Mounting hole and assembly tools shown on page 123.

Featuring Twist Pin, Pin and Socket Contacts

(Continued)

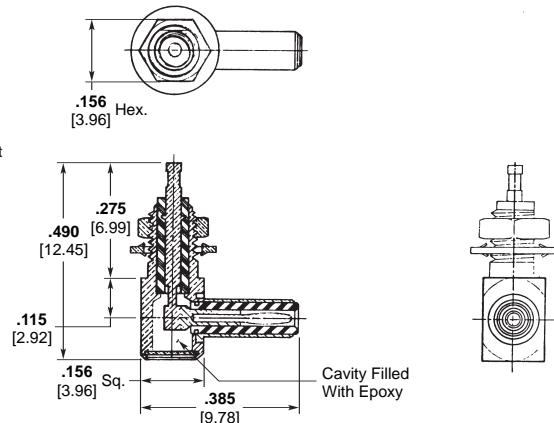
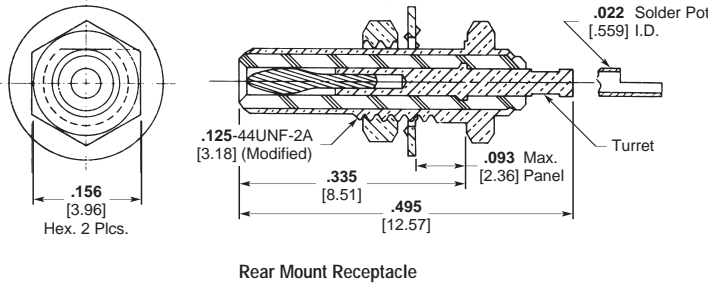

Part No.	Contact Tail
141-1003-0001	Turret
141-1003-0002	Solder Pot

Mounting Hole shown below.

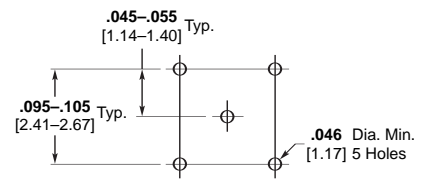
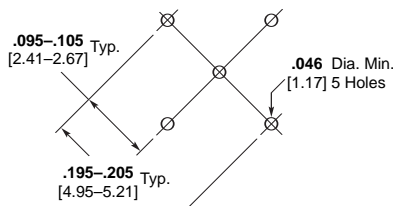
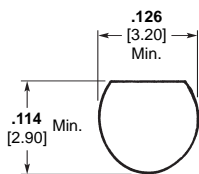
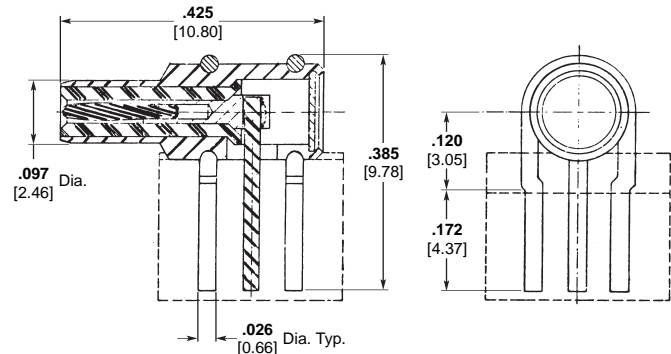
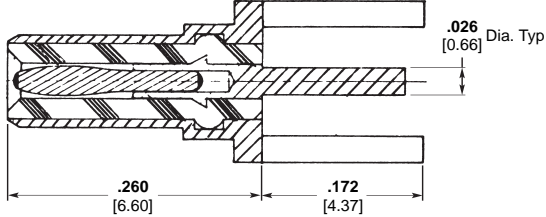

Printed Circuit Receptacle Mounting Hole Pattern

LEPRA/CON Connector Assembly Tools



Housing Crimp Tool



Contact Crimp Tool

MICRODOT Part No.	Thomas & Betts Part No.
010-0132-0000	WT-419

Connector	Contact Crimp No.	Astro Tool Part No.
Straight Connector Only	010-0150-0000	A-826-1
141-1001-0001	010-0161-0000	827

BNC / LEPRA/CON Connector Adapters

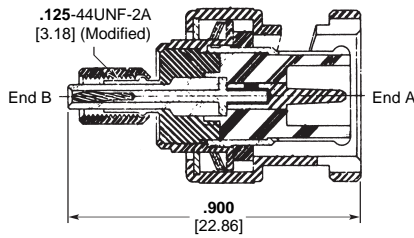

End "B" is MICRODOT Screw-On Plug End "A" is BNC Plug
Part Number 143-0001-0001

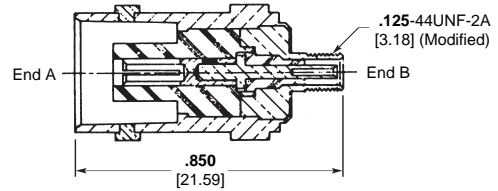

End "A" is BNC Receptacle End "B" is MICRODOT Screw-On Receptacle
Part Number 143-0003-0001

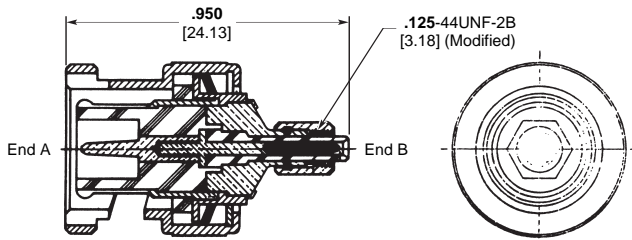

End "A" is BNC Plug End "B" is MICRODOT Screw-On Plug with Locking Interface
Part Number 143-0029-0001

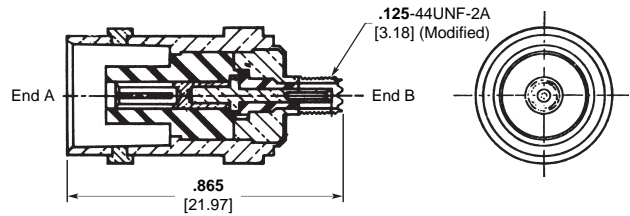

End "A" is BNC Receptacle End "B" is MICRODOT Screw-On Receptacle with Locking Interface
Part Number 143-0032-0001

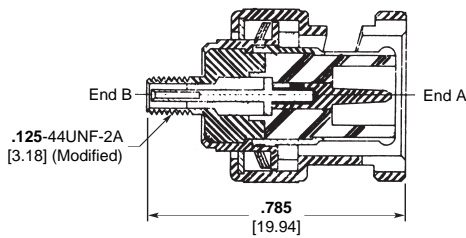

End "B" is Screw-On Receptacle End "A" is BNC Plug
Part Number 143-0002-0001

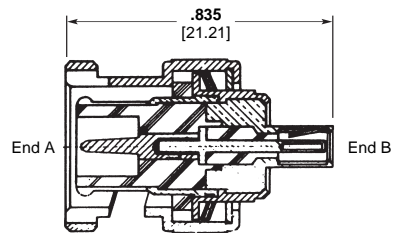

End "A" is BNC Plug End "B" is MICRODOT Slide-On Plug
Part Number 143-1000-0001

BNC / LEPRA/CON Connector Adapters

(Continued)

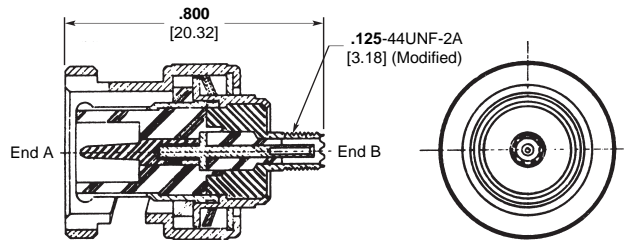

End "A" is BNC Plug End "B" is MICRODOT Receptacle with Locking Interface
Part Number 143-0031-0001

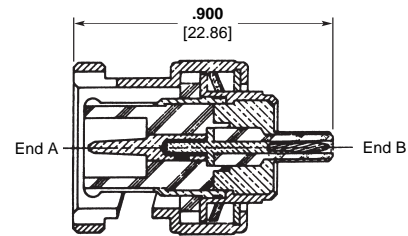

End "A" is BNC Plug End "B" is MICRODOT Slide-On Receptacle
Part Number 143-1002-0001

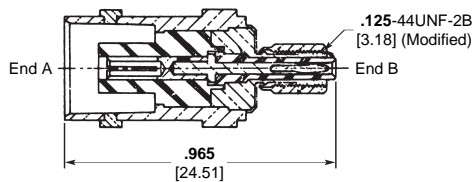

End "A" is BNC Receptacle End "B" is MICRODOT Screw-On Plug
Part Number 143-0004-0001

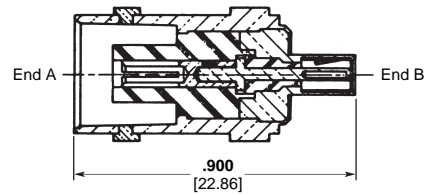

End "A" is BNC Receptacle End "B" is MICRODOT Slide-On Plug
Part Number 143-1001-0001

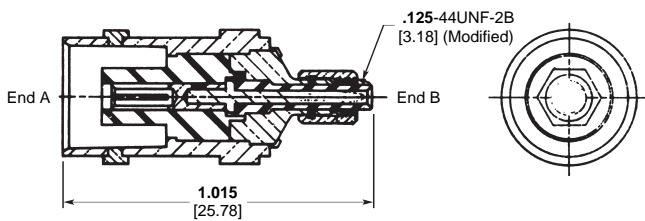

End "A" is BNC Receptacle End "B" is MICRODOT Screw-On Plug with Locking Interface
Part Number 143-0030-0001

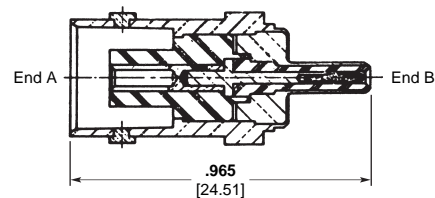

End "A" is BNC Receptacle End "B" is MICRODOT Slide-On Receptacle
Part Number 143-1003-0001