	TYPE	PRODUCT SPECIFICATION		NUMBER	DPS-12-011
	TITLE			PAGE	REVISION
MINITEK II CONNECTORS			1 of 10	H	
			AUTHORIZED BY	DATE	
			KH LEE	6 OCT 2006	
			CLASSIFICATION		
			UNRESTRICTED		

1. SCOPE

Minitex II connector is a double rows, vertical card connector designed for used on 2.0mm center to center holes and available in vertical and right angle applications. This specification is intended to cover the performance and evaluation conditions of the connector.

2. MATERIAL & FINISH

2.1 Terminal

Material : Phosphor Bronze
 Finish : Overall 1.27 um Min Nickel underplate
 Solder tail - (a) 1.5-7.6 um Min Tin/Lead (85/15) plating
 (b) 2.54 um Min 100% matte tin
 Contact area - (a) 0.76 um Min Au
 (b) 0.38 um Min Au
 (c) 0.20 um Min Au

2.2 Housing

a) Material : Glass-filled PBT
 Color : Black
 Flammability : UL 94V-0

b) Material : Glass-filled PCT
 Color : Beige/Black
 Flammability : UL 94V-0

2.3 Header Pin

Material : Phosphor Bronze
 Finish : (a) 0.20 um Min Au over 1.27 um Nickel underplate
 (b) 0.76 um Min Au over 1.27 um Nickel underplate
 (c) 0.38 um Min Au over 1.27 um Nickel underplate
 (d) 0.38 um Min GXT Palladium-Nickel Alloy over 1.27 um Nickel underplate
 (e) 0.76 um Min GXT Palladium-Nickel Alloy over 1.27 um Nickel underplate

2.4 Header Body

a) Material : Glass-filled Nylon 6,6
 Color : Black
 Flammability : UL 94V-0

b) Material : Glass-filled PCT
 Color : Beige/Black
 Flammability : UL 94V-0

	TYPE	PRODUCT SPECIFICATION		NUMBER	DPS-12-011	
	TITLE	MINITEK II CONNECTORS		PAGE	2 of 10	
				REVISION	H	
			AUTHORIZED BY	KH LEE	DATE	6 OCT 2006
			CLASSIFICATION	UNRESTRICTED		

3. PERFORMANCE REQUIREMENTS

- 3.1 Rating Voltage : 200V, AC/DC
- 3.2 Rating Current : 2A, AC/DC
- 3.3 Operating Temperature Range : -40°C to 105°C (For Nylon 6,6 & PBT mat'l)
-55°C to 125°C (For PCT material)
(including temperature rise caused by application of current)
- 3.4 Performance

Unless otherwise specified, when tested under the ambient conditions in accordance with JIS-5020 as described below and evaluated with the sequence listed in Table 1, the connector shall meet the requirements in Para. 3.5.

- (a) Temperature : 5°C to 35°C
- (b) Relative Humidity : 45 to 85%
- (c) Atmospheric Pressure : 860 to 1060 mb

3.5 Requirements

3.5.1 Electrical Characteristics

3.5.1.1 Contact Resistance

The contact resistance shall not exceed 20m Ω before test or 25m Ω after test when measured under the following conditions :-

- (a) Method of Connection : See Figure 1
- (b) Test Current : 10mA DC
- (c) Open Circuit Voltage : 20mV DC

3.5.1.2 Insulation Resistance

The insulation resistance of the unmated connector shall not be less than 1000M Ω when measured in accordance with MIL-STD-202, Method 302. The following details shall apply :-

- (a) Test Voltage : 500V DC for 1 Minute
- (b) Special Preparation : The connector shall not be mounted on PC Board
- (c) Points of Measurement: Between adjacent terminals

	TYPE	PRODUCT SPECIFICATION		NUMBER	DPS-12-011		
	TITLE	MINITEK II CONNECTORS		PAGE	3 of 10	REVISION	H
				AUTHORIZED BY	KH LEE	DATE	6 OCT 2006
				CLASSIFICATION	UNRESTRICTED		

3.5.1.3 Dielectric Withstanding Voltage

There shall be no evidence of arc-over or insulation breakdown when the unmated connector is tested in accordance with MIL-STD-202, Method 301. The following details shall apply :-

- (a) Test Voltage : 650V AC for 1 Minute
- (b) Special Preparation : The connector shall not be mounted on the PC Board
- (c) Points of Measurement: Between adjacent terminals

3.5.1.4 Temperature Rise

The temperature rise shall not exceed 30°C when measured using thermocouple under the following conditions :-

- (a) Current Applied : 2A DC
- (b) Special Preparation : The connector shall be connected in series
- (c) Points of Measurement: At a terminal located at or near the middle of the connector

3.5.2 Environmental Characteristics

3.5.2.1 High Temperature

There shall be no evidence of cracking, swelling or other damage which would be detrimental to the function of the connector. The contact resistance shall not exceed 25mΩ after the mated connector is exposed to a high temperature environment in accordance with MIL-STD-202, Method 108A.

The following details shall apply :-

- (a) Ambient Temperature : 105 ± 2°C
- (b) Duration : 44 Hours

	TYPE	PRODUCT SPECIFICATION		NUMBER	DPS-12-011	
	TITLE	MINITEK II CONNECTORS		PAGE	4 of 10	
				REVISION	H	
			AUTHORIZED BY	KH LEE	DATE	6 OCT 2006
			CLASSIFICATION	UNRESTRICTED		

3.5.2.2 Humidity

There shall be no evidence of cracking, swelling or other damage which would be detrimental to the function of the connector after the mated connector is exposed to a high humidity ambience in accordance with MIL-STD-202, Method 103B. The contact resistance shall not exceed 25m Ω and insulation resistance shall not be less than 100m Ω .

The dielectric withstanding voltage test shall be performed after the humidity test and the connector shall meet the requirements described in Para. 3.5.1.3.

The following details shall apply :-

- (a) Ambient Temperature : 40 \pm 2°C
- (b) Relative Humidity : 90 to 95%
- (c) Duration : 96 Hours

3.5.2.3 Salt Spray

There shall be no evidence of cracking, swelling or oxidation which would be detrimental to the function of the connector and the contact resistance shall not exceed 25m Ω after the mated connector is exposed to a salt fog ambience in accordance with MIL-STD-202, Method 101D.

The following details shall apply :-

- (a) Salt Solution : 5% By Weight
- (b) Ambient Temperature : 35°C
- (c) Duration : 48 Hours
- (d) Specific Treatment : The measurement shall be conducted after the mated conductor is mildly rinsed in running water to remove deposition of salt, followed by natural drying by placing it for 24 hours at room temperature.

	TYPE	PRODUCT SPECIFICATION		NUMBER	DPS-12-011		
	TITLE	MINITEK II CONNECTORS		PAGE	5 of 10	REVISION	H
				AUTHORIZED BY	KH LEE	DATE	6 OCT 2006
				CLASSIFICATION	UNRESTRICTED		

3.5.2.4 Thermal Shock

There shall be no evidence of cracking, swelling or other damage which would be detrimental to the function of the connector after the mated connector is exposed to alternate cycles of extreme high and low temperature in accordance with MIL-STD-202, Method 107D. The contact resistance shall not exceed 25mΩ.

The following details shall apply :-

- (a) Temperature Range : $-55^{+0^{\circ}\text{C}}$
 -3°C for 30 minutes
followed by
 $85^{+3^{\circ}\text{C}}$
 -0°C for 30 minutes
- (b) Number of Cycles : 5 Cycles

3.5.2.5 Hydrogen Sulfide (H₂S) Exposure

There shall be no evidence of cracking, swelling or oxidation which would be detrimental to the function of the connector and the contact resistance shall not exceed 25mΩ after the mated connector is exposed to a moist H₂S environment.

The following details shall apply :-

- (a) Ambient Temperature : 40°C
(b) Relative Humidity : 70 to 80%
(c) H₂S Density : 10 ± 5 PPM
(d) Duration : 96 Hours

	TYPE	PRODUCT SPECIFICATION		NUMBER	DPS-12-011		
	TITLE	MINITEK II CONNECTORS		PAGE	6 of 10	REVISION	H
				AUTHORIZED BY	KH LEE	DATE	6 OCT 2006
				CLASSIFICATION	UNRESTRICTED		

3.5.3 Mechanical Characteristics

3.5.3.1 Vibration

There shall be no evidence of physical or mechanical damage, or disassociation of parts, and no evidence of discontinuity greater than 1 microsecond when the mated connector is subjected to mechanical vibration. The contact resistance shall not exceed 25mΩ after the test. The test shall be in accordance with MIL-STD-202, Method 201A, and the following details shall apply :-

- (a) Frequency : 10-55-10 Hz/Min,
Sweep Vibration
- (b) Amplitude : 1.5mm Max.
- (c) Test Current : 0.1A
- (d) Duration : 2 hours along each of
three perpendicular
axes (6 hours total)
- (e) Mounting : See Figure 2

3.5.3.2 Contact Retention Force in Housing

Each contact retention force shall be more than 0.5 kg when the solder leg is pushed along axial direction at the speed of 25mm/min.

3.5.3.3 Post Retention Force in Header

Each post retention force shall be 1.0 kg min. when the post is pushed along axial direction at the speed of 25mm/min.

3.5.3.4 Mating/Unmating Force

When the connector is subjected to 20 cycles of mating/unmating operation, insertion and withdrawal forces shall conform to the following requirements at initial, 10th and 20th cycles :-

- (a) Insertion Force : 180g x Pos Max.
- (b) Withdrawal Force : 20g x Pos Min.

	TYPE	PRODUCT SPECIFICATION		NUMBER	DPS-12-011		
	TITLE	MINITEK II CONNECTORS		PAGE	7 of 10	REVISION	H
				AUTHORIZED BY	KH LEE	DATE	6 OCT 2006
				CLASSIFICATION	UNRESTRICTED		

3.5.3.5 Durability

Contact resistance after 100 cycles of mating/unmating operation shall not exceed 25m Ω .

3.5.3.6 Solderability

The test shall be applied to solder leg of both contact and post. No less than 90% of the dipped surface of the solder leg is dipped in solder bath. The test shall be in accordance with MIL-STD-202, Method 208C, and the following details shall apply :-

- (a) Flux : Alpha 100, GX-5 or GX-7
- (b) Solder : 60-40 Tin/Lead
- (c) Flux Immersion Time : 5 to 10 Seconds
- (d) Solder Temperature : 230°C \pm 5°C
- (e) Dipping Time : 3 \pm 0.5 Seconds

3.5.3.7 Solder-Heat Resistance

The test shall be applied to solder leg of both contact and post. There shall be no evidence of physical damage detrimental to the function of the connector when each solder leg of the connector mounted onto a PC Board is dipped in a bath.

The following details shall apply :-

- (a) Solder Temperature : 260°C \pm 5°C
- (b) Dipping Time : 5 \pm 0.5 Seconds
- (c) Immersion Depth : The end of the solder leg coming through the PCB Board

	TYPE PRODUCT SPECIFICATION	NUMBER DPS-12-011	
	TITLE MINITEK II CONNECTORS	PAGE 8 of 10	REVISION H
AUTHORIZED BY KH LEE		DATE 6 OCT 2006	
CLASSIFICATION UNRESTRICTED			

CONTACT RESISTANCE

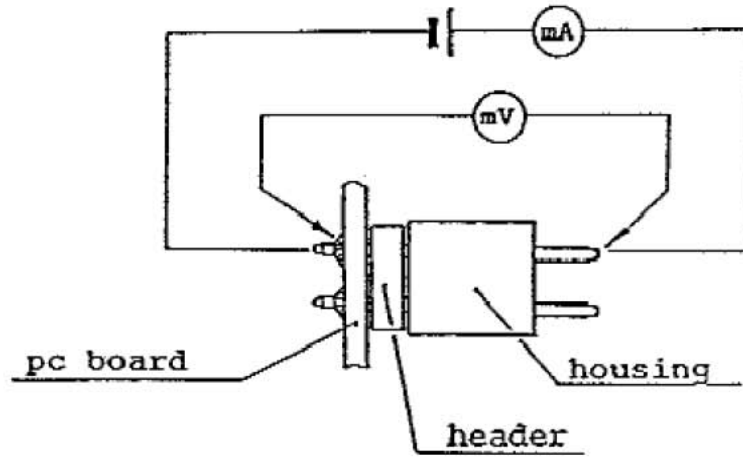

Fig. 1

VIBRATION

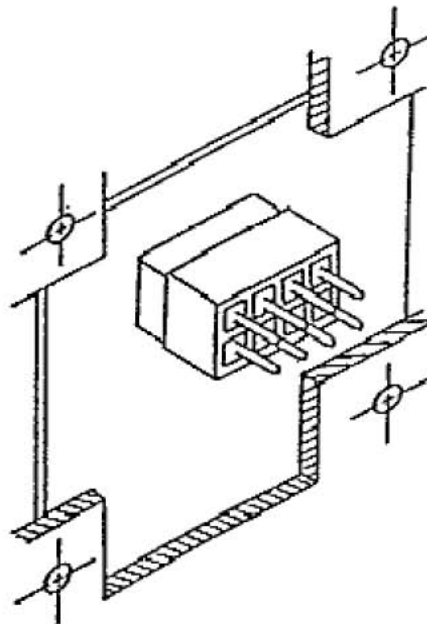



Fig. 2

	TYPE	PRODUCT SPECIFICATION	NUMBER	DPS-12-011
	MINITEK II CONNECTORS		PAGE	9 of 10
AUTHORIZED BY			KH LEE	
		REVISION	H	
		DATE	6 OCT 2006	
		CLASSIFICATION	UNRESTRICTED	

TEST DESCRIPTION	TEST GROUP														TEST METHOD
	1	2	3	4	5	6	7	8	9	10	11	12	13	14	
1 CONTACT RESISTANCE															3.5.1.1
2 INSULATION RESISTANCE	①④		①②③④⑤⑥⑦⑧⑨⑩⑪⑫⑬⑭												3.5.1.2
3 DIELEC. WITHSTANDING VOLT	②⑤														3.5.1.3
4 TEMPERATURE RISE		①													3.5.1.4
5 HIGH TEMPERATURE			②												3.5.2.1
6 HUMIDITY	③			②											3.5.2.2
7 SALT SPRAY					②										3.5.2.3
8 THERMAL SHOCK						②									3.5.2.4
9. HYDROGEN SULFIDE EXPOSURE							②								3.5.2.5
10 VIBRATION								②							3.5.3.1
11 CONTACT RETENTION FORCE									①						3.5.3.2
12 POST RETENTION FORCE										①					3.5.3.3
13 MATING/UNMATING FORCE											①				3.5.3.4
14 DURABILITY												②			3.5.3.5
15 SOLDERABILITY													①		3.5.3.6
16 SOLDER HEAT RESISTANCE														①	3.5.3.7

NOTE : NUMBERS INDICATE SEQUENCE IN WHICH TESTS ARE PERFORMED.

TABLE 1 : TEST SEQUENCE

	TYPE	PRODUCT SPECIFICATION		NUMBER	DPS-12-011		
	TITLE			PAGE	10 of 10	REVISION	H
MINITEK II CONNECTORS			AUTHORIZED BY	KH LEE		DATE	6 OCT 2006
			CLASSIFICATION			UNRESTRICTED	

REVISED RECORD

<u>REV</u>	<u>PAGE</u>	<u>ECR</u>	<u>DATE</u>
A	01	S00028	23 APR 90
B	06	S00244	02 OCT 90
C	02	V12369	22 AUG 91
D	01	S10307	11 SEP 91
E	07	S20204	29 JUL 92
F	02	S30339	22 SEP 93
G	01	S04-0259	02 DEC 04
H	ALL	S06-0334	06 OCT 06