



DS78L12/DS88L12 Hex TTL-MOS Inverter/Interface Gate

General Description

The DS78L12/DS88L12 is a low power TTL to MOS hex inverter element. The outputs may be "pulled up" to +14V in the logical "1" state, thus providing guaranteed interface between TTL and MOS logic levels. The gate may also be

operated with V_{CC} levels up to +14V without resistive pull-ups at the outputs and still providing a guaranteed logical "1" level of $V_{CC} - 2.2V$ with an output current of $-200 \mu A$.

Schematic and Connection Diagrams

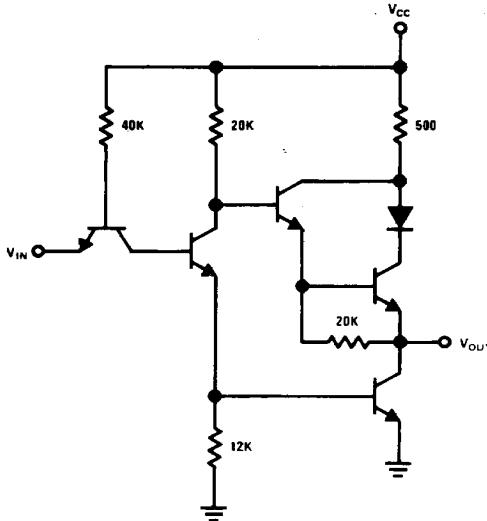

Note: Shown is schematic for each inverter.

TL/F/8584-1

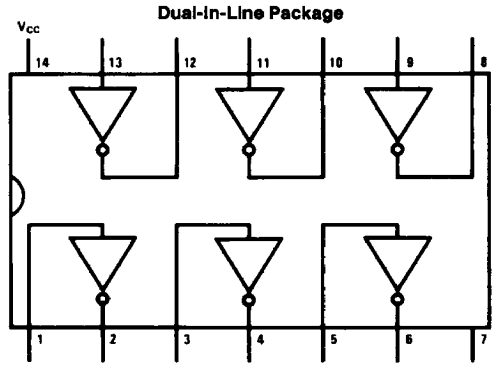

Dual-In-Line Package

Top View

TL/F/8584-2

Order Number DS78L12J, DS88L12J,
DS88L12N and DS78L12W
See NS Package Number J14A, N14A or W14B

Typical Applications

TTL Interface to MOS ROM
without Resistive Pull-Up

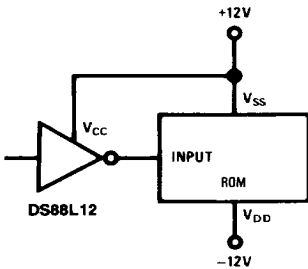

TL/F/8584-3

TTL Interface to MOS ROM
with Resistive Pull-Up

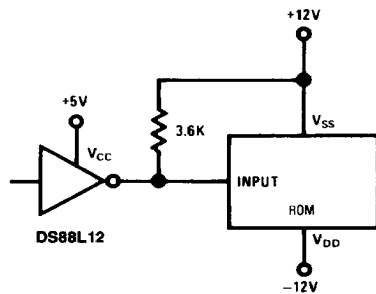

TL/F/8584-4

Absolute Maximum Ratings (Note 1)

If Military/Aerospace specified devices are required, please contact the National Semiconductor Sales Office/Distributors for availability and specifications.

Supply Voltage	15V
Input Voltage	5.5V
Output Voltage	15V
Storage Temperature Range	-65°C to +150°C
Maximum Power Dissipation* at 25°C	
Cavity Package	1308 mW
Molded Package	1207 mW
Lead Temperature (Soldering, 4 sec.)	260°C

*Derate cavity package 8.72 mW/°C above 25°C; derate molded package 8.66 mW/°C above 25°C.

Operating Conditions

	Min	Max	Units
Supply Voltage (V_{CC})			
DS78L12	4.5	5.5	V
DS88L12	4.75	5.25	V
Temperature (T_A)			
DS78L12	-55	125	°C
DS88L12	0	70	°C

Electrical Characteristics (Notes 2 and 3)

Symbol	Parameter	Conditions	Min	Typ	Max	Units	
V_{IH}	Logical "1" Input Voltage	$V_{CC} = 14.0V$	2.0	1.3		V	
		$V_{CC} = \text{Min}$	2.0	1.3		V	
V_{IL}	Logical "0" Input Voltage	$V_{CC} = 14.0V$		1.3	0.7	V	
		$V_{CC} = \text{Min}$		1.3	0.7	V	
V_{OH}	Logical "1" Output Voltage	$V_{IN} = 0.7V$					
		$V_{CC} = 14.0V, I_{OUT} = -200 \mu A$	11.8	12.0		V	
		$V_{CC} = \text{Min}, I_{OUT} = -200 \mu A$	14.5	15.0		V	
		$V_{IN} = 0V, V_{CC} = \text{Min}, I_{OUT} = -5.0 \mu A$ (Note 6)				V	
V_{OL}	Logical "0" Output Voltage	$V_{IN} = 2.0V$					
		$V_{CC} = 14.0V, I_{OUT} = 12 \text{ mA}$		0.5	1.0	V	
		$V_{CC} = \text{Min}, I_{OUT} = 3.6 \text{ mA}$		0.2	0.4	V	
I_{IH}	Logical "1" Input Current	$V_{IN} = 2.4V$	$V_{CC} = 14.0V$		<1	20	μA
			$V_{CC} = \text{Max}$		<1	10	μA
		$V_{IN} = 5.5V$	$V_{CC} = 14.0V$		<1	100	μA
			$V_{CC} = \text{Max}$		<1	100	μA
I_{IL}	Logical "0" Input Current	$V_{IN} = 0.4V$	$V_{CC} = 14.0V$		-320	-500	μA
			$V_{CC} = \text{Max}$		-100	-180	μA
I_{SC}	Output Short Circuit Current	$V_{OUT} = 0V$ (Note 4)	$V_{CC} = 14.0V$	-10	-25	-50	mA
			$V_{CC} = \text{Max}$	-3	-8	-15	mA
I_{CCH}	Supply Current—Logical "1" (Each Inverter)	$V_{IN} = 0V$	$V_{CC} = 14.0V$		0.32	0.50	mA
			$V_{CC} = \text{Max}$		0.11	0.16	mA
I_{CCL}	Supply Current—Logical "0" (Each Inverter)	$V_{IN} = 5.25V$	$V_{CC} = 14.0V$		1.0	1.5	mA
			$V_{CC} = \text{Max}$		0.3	0.5	mA

Switching Characteristics $T_A = 25^\circ C$, nominal power supplies unless otherwise noted

Symbol	Parameter	Conditions	Min	Typ	Max	Units	
t_{pd0}	Propagation Delay to a Logical "0" from Input to Output	$T_A = 25^\circ C$	$V_{CC} = 5.0V$ (Figure 2)		27	45	ns
			$V_{CC} = 14.0V$ (Figure 1)		11	20	ns
t_{pd1}	Propagation Delay to a Logical "1" from Input to Output	$T_A = 25^\circ C$	$V_{CC} = 5.0V$ (Figure 2), (Note 5)		79	100	ns
			$V_{CC} = 14.0V$ (Figure 1)		34	55	ns

Note 1: "Absolute Maximum Ratings" are those values beyond which the safety of the device cannot be guaranteed. Except for "Operating Temperature Range" they are not meant to imply that the devices should be operated at these limits. The table of "Electrical Characteristics" provides conditions for actual device operation.

Note 2: Unless otherwise specified min/max limits apply across the -55°C to +125°C temperature range for the DS78L12 and across the 0°C to +70°C range for the DS88L12.

Note 3: All currents into device pins shown as positive, out of device pins as negative, all voltages referenced to ground unless otherwise noted. All values shown as max or min on absolute value basis.

Note 4: Only one output at a time should be shorted.

Note 5: t_{pd1} for $V_{CC} = 5.0V$ is dependent upon the resistance and capacitance used.

Note 6: $V_{OH} = V_{CC} - 1.1V$ for the DS88L12 and $V_{CC} - 1.4V$ for the DS78L12.

AC Test Circuits

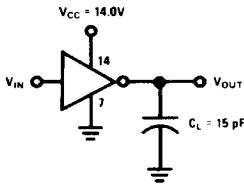

For $V_{CC} = 14V$

FIGURE 1

TL/F/8584-5

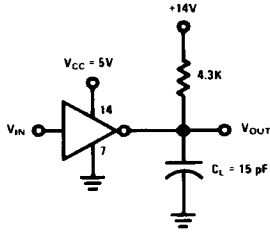

For $V_{CC} = 5.0V$

FIGURE 2

TL/F/8584-6

Switching Time Waveforms

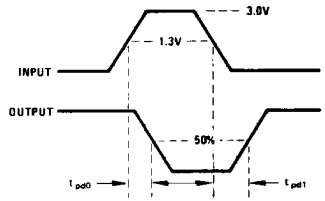

$f = 1 \text{ MHz}$
 $t_r = t_f = 10 \text{ ns}$
 $PW = 100 \text{ ns}$

TL/F/8584-7