

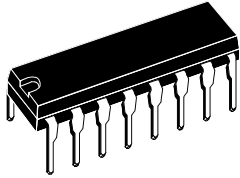

STV9936P/S

120-MHz On-Screen Display for Monitors with 4 True Independent Window Displays



PDIP16 (Plastic Dual In line Package)
ORDER CODE: STV9936P

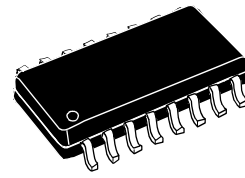

SO16 Narrow (Plastic Micropackage)
ORDER CODE: STV9936S

Main Features

- Horizontal frequency up to 150 kHz
- On-chip Pixel Clock Generator from 7.68 MHz to 120 MHz, without crystal oscillator
- 16-pin Narrow SO or DIP packages
- Programmable horizontal resolutions from 384 to 1524 dots per scan line
- 4 independent windows all with character display
- Overlapping windows with automatic control of display priorities and scrolling menu effects
- Independent and programmable displays, positions and sizes for each window
- Transparent or 8 programmable background colors for each window
- Window size up to 16 rows of 32 characters
- Each window has its own bordering or shadowing effects with programmable color, height and width
- Each window can be separately erased
- Programmable common positioning to easily control centered display
- 256 standard and 16 multi-color characters or graphic fonts in ROM. Character fonts can be customized using a mask-programmable ROM
- Characters
 - Common character height and row space. Character height from 18 to 127 lines and space lines from 0 to 62 split above and below character rows
 - 12 x 18 dot matrix per character
 - Display of up to 704 characters
 - Programmable shadow/border effects for characters in each separate window
 - 32 programmable background, foreground, blinking character colors for each character (8 possibilities per window)
 - 8 selectable colors for standard characters
 - Transparent and 8 selectable colors for background
- On-Screen Effects
 - Fade-in/Fade-out effects
 - Possibility of full-screen display with a selectable color
- I²C interface for microcontrollers with slave address BA(h) in Read and Write modes

Table of Contents

Chapter 1	General Description	5
1.1	Pin Description	7
Chapter 2	Register Addressing	8
2.1	I ² C Protocol	8
2.1.1	Data to Write	8
2.1.2	Transmission Formats	8
2.1.3	Format, Window and Row Address (FWR)	9
2.1.4	Format, Attribute and Column Address (FAC)	9
2.1.5	Control Data, Color Codes or Character Codes (D)	10
2.1.6	Configuration of Transmission Formats	10
2.2	Format Changing	10
2.3	Read Mode	11
2.4	Addressing Map	11
Chapter 3	Window Specifications	12
3.1	Enable Display	13
3.2	Origin Positions for the 4 Windows	13
3.2.1	General Horizontal Delay (HD)	13
3.2.2	General Vertical Delay (VD)	13
3.3	Window Positions in the Frame	14
3.3.1	Window Horizontal Delay	14
3.3.2	Window Vertical Delay	14
3.4	Window Size: Number of Character Rows and Character Columns	15
3.4.1	Window Horizontal Size	15
3.4.2	Window Vertical Size	15
3.5	Window Background Color	16
3.6	Window Bordering and Shadowing Effects	16
3.6.1	Enable Bordering or Shadowing Effects	16
3.6.2	Bordering or Shadowing Selection	16
3.6.3	Border or Shadow Color	17
3.6.4	Bordering or Shadowing Size	17
3.7	Window Display Priority Management	18
Chapter 4	Character Specifications	19
4.1	General Description	19
4.2	Horizontal Resolution	19
4.3	Character Height	19

4.4	Row Height (Space Lines)	20
4.5	Character Colors	21
4.5.1	Character Background Color	21
4.5.2	Character Color	22
4.5.3	Character Blinking Effect	23
4.6	Multicolor Characters	23
4.7	Character Shadowing	23
4.8	Character Font	25
Chapter 5	RAM Specification	28
5.1	Character Coding	28
5.2	Window Memory Allocation	28
5.3	Memory Size Allocation	28
5.4	Window Reset	30
Chapter 6	Pixel Clock Generator	31
Chapter 7	General OSD Programming	32
7.1	Enable OSD	32
7.2	Fade-in and Fade-out Effect	32
7.3	Full Screen Display	32
7.4	Signal Polarity and Triggering	33
7.5	Reset	34
Chapter 8	Registers	35
8.1	Register Specification	35
Chapter 9	Application Hints	38
9.1	Software Hints	38
9.1.1	Programming Recommendations	38
9.1.2	Examples of Programming	38
9.2	Hardware Hints	39
Chapter 10	Application Diagrams	40
Chapter 11	Electrical and Timing Characteristics	42
11.1	Absolute Maximum Ratings	42
11.2	Operating Conditions	42

11.3	Electrical and Timing Characteristics	42
11.4	I ² C Bus Characteristics	43
Chapter 12	Package Mechanical Data	44
12.1	SO16 Narrow Plastic Micropackage	44
12.2	Dual In-line Plastic Package	45
Chapter 13	Revision History	47

Obsolete Product(s) - Obsolete Product(s)

1 General Description

The STV9936 is a new On-Screen Display (OSD) device with multiple menu displays for monitor applications.

In addition to the standard features of an OSD, the special features of the STV9936 are listed below:

- Simultaneous display of up to 4 menus anywhere on the screen. Each of the 4 independent windows, all displaying characters, can be overlapped and display priorities are automatically controlled. Window sizes and positions are independently programmable as well as scrolling menu effects.
- Programming of the general OSD and of the 4 windows is controlled by an I²C bus in Read and Write modes, to suit the various CRT displays.
- Associated with an easily programmable character height, the internal PLL generates the programmable pixel clock, without using a crystal oscillator, that defines the character width making the device suitable for multi-sync applications.
- A maximum of 704 characters, defined in the mask-programmable ROM, are distributed among the 4 windows and displayed simultaneously.

Figure 1: Multi-window Concept with Character Display

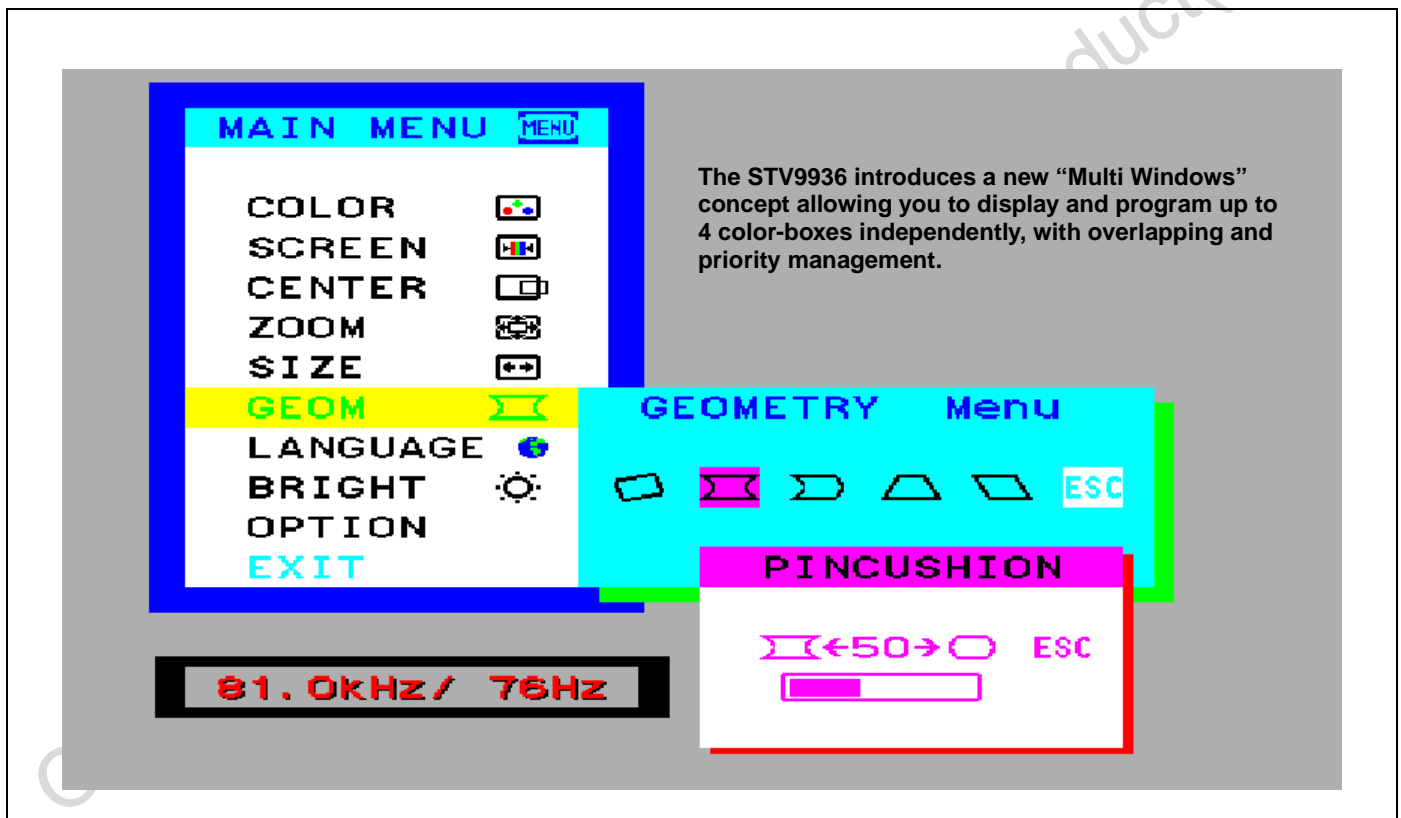
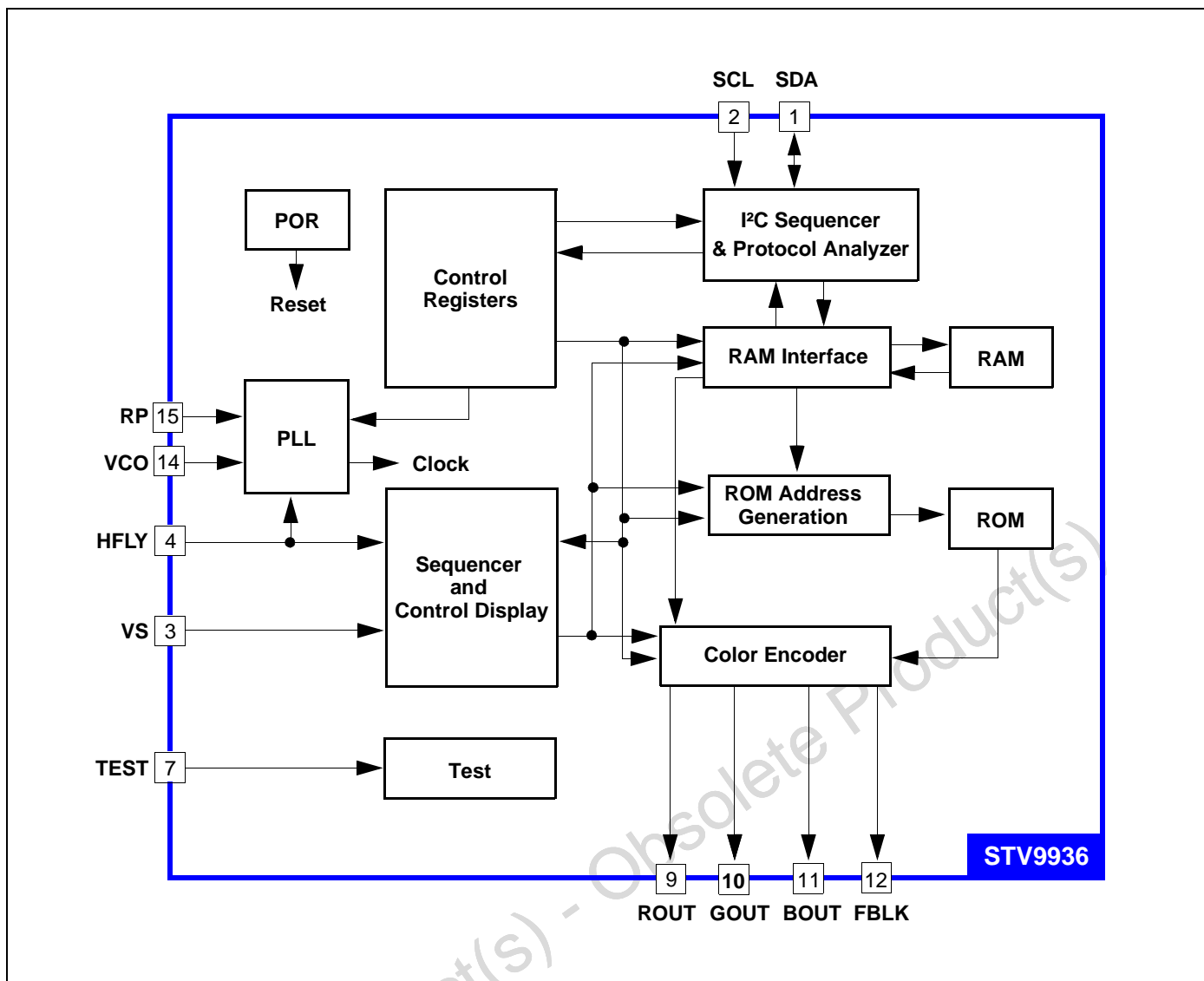

Figure 2: STV9936 Block Diagram



1.1 Pin Description

Figure 3: Pin Connections

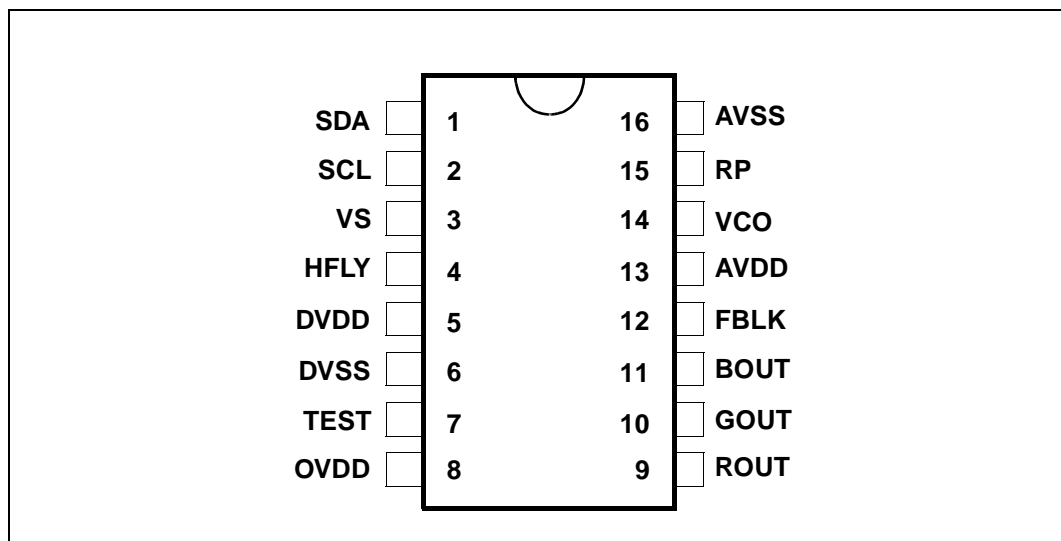

Table 1: Pin Descriptions

N°	Pin Name	Direction	Digital/ Analog	Function
1	SDA	I/O	Digital	Serial Data of I ² C bus
2	SCL	Input	Digital	Serial Clock of I ² C bus
3	VS	Input	Digital	Vertical Synchronization Input
4	HFLY	Input	Digital	Horizontal Synchronization Input
5	DVDD	-	Supply	Digital Power Supply
6	DVSS	-	Supply	Digital Ground
7	TEST	Input	Digital	Remains at 0 (for test purposes only)
8	OVDD	-	Supply	Digital Power Supply
9	ROUT	Output	Digital	Red Color Output
10	GOUT	Output	Digital	Green Color Output
11	BOUT	Output	Digital	Blue Color Output
12	FBLK	Output	Digital	Fast Blanking Output
13	AVDD	-	Supply	Analog Power Supply
14	VCO	I/O	Analog	for VCO
15	RP	I/O	Analog	for VCO
16	AVSS	-	Supply	Analog Ground

2 Register Addressing

All control registers are located in Window 0, Row 0. All color-box data is located in Window 0, Row 2.

Three formats are available: A, B and C, as described in the I²C protocol (see [Section 2.1: I²C Protocol on page 8](#)).

All addresses (FAC and FWR bytes) are based on Formats A or B, and are written in hexadecimal format.

Data in Window 0, Row 1 is reserved. DO NOT write to this location.

2.1 I²C Protocol

The serial interface with the microcontroller is an I²C bus with 2 wires: SCL and SDA. The OSD is a slave circuit with 2 modes: Write and Read.

2.1.1 Data to Write

In the OSD, the I²C bus is used to write - read:

- the control data
- the character codes and their respective color codes
- the color-boxes (8 color-boxes per window).

A color-box contains the character color, character background color and blink data. There are 8 color-boxes for each OSD window which are used to define the colors available for all the characters of the given OSD window. 3 bits are required to code the 8 color-boxes. These bits are the color code.

For more information, refer to [Section 4.5: Character Colors on page 21](#).

Each character code is related to its own window, row and column. Consequently, the protocol of the I²C transmission includes this information (window, row and column) to define the position of the character on the screen. These 3 pieces of information about the position are transmitted in 2 bytes.

As each character on the screen has its own color code, the same protocol is used to write all the color codes and character codes. Only the bit called 'A' allows you to distinguish the character codes from the color codes corresponding to 1 position on the screen.

The control data is also written with the same protocol using windows, rows and columns. Window 0 is reserved for control data and color boxes.

2.1.2 Transmission Formats

There are 3 transmission formats to suit the amount of data to update. The transmission format is coded in the "window/row/column" bytes.

Format A is suitable for updating small amounts of data which are allocated to different window, row and column addresses.

Format B is recommended for updating data for the same window and the same row address, but with a different column address and when changing the Character/Color-code attribute (bit A), or when writing to a different I²C control register.

Format C is appropriate for updating large amounts of data from a full window or full screen. The window, row and column addresses are incremented automatically when this format is applied. Data is written to fill all the allocation memory of the windows.

The transmission formats are as follows:

1. Format A: S-FWR-FAC-D → FWR-FAC-D → FWR-FAC-D → FWR-FAC-D...Stop
2. Format B: S-FWR-FAC-D → FAC-D → FAC-D → FAC-D...Stop
3. Format C: S-FWR-FAC-D → D → D → D...Stop

Where:

S = Slave address = BAh

FWR = Format, Window and Row address

FAC = Format, Attribute and Column address

D = Control data, Color codes (3 bits) or Character codes (8 bits).

In Format C, the order of automatic incrementation for data D is first the column value, then the row value, and then the window value.

Table 2: Various Bytes coded in the I²C Transmission

Byte	Bit 7	Bit 6	Bit 5	Bit 4	Bit 3	Bit 2	Bit 1	Bit 0
FWR	1	W[2:0]			R[3:0]			
FAC	0	F	A	C[4:0]				
D: Control Data (in window 0 only)	D[7:0]							
D: Color Code	0	0	0	0	0	D[2:0]		
D: Character Code	D[7:0]							

2.1.3 Format, Window and Row Address (FWR)

Bit 7 indicates the 'Window & Row' byte when set to 1.

W[2:0]: Window Number

000: Control Data and Color boxes

001: Window 1

010: Window 2

011: Window 3

100: Window 4

R[3:0]: Row Number from 0 to 15. Each window has a maximum number of 16 rows.

2.1.4 Format, Attribute and Column Address (FAC)

Bit 7 indicates the 'Attribute & Column' byte when set to 0.

F: Format

0: Format A or B

1: Format C

A: Transmission of character code or color code

0: Character Code

1: Color Code

When reading or writing control data and/or color boxes, bit A must be set to 0. For Character codes, A must be set to 1.

C[4:0]: Column Number

There are 32 possible columns.

00000: 1 column

11111: 32 columns

2.1.5 Control Data, Color Codes or Character Codes (D)

Color codes are stored on 3 bits. Control data and Character codes are stored on 8 bits.

2.1.6 Configuration of Transmission Formats

Table 3: Configuration of Transmission Formats

		Byte	Format	Bit 7	Bit 6	Bit 5	Bit 4	Bit 3	Bit 2	Bit 1	Bit 0
Address bytes for Characters Codes	Windows & Rows	FWR	A, B or C	1	W[2:0]			R[3:0]			
	Column (A and B)	FAC	A or B	0	0	0	C[4:0]				
	Column (C)	FAC	C	0	1	0	C[4:0]				
Address bytes for Color Codes	Windows & Rows	FWR	A, B or C	1	W[2:0]			R[3:0]			
	Column (A and B)	FAC	A or B	0	0	1	C[4:0]				
	Column (C)	FAC	C	0	1	1	C[4:0]				

All formats must start with the S, FWR and FAC bytes.

All FAC values referred to in this datasheet correspond to transmission formats A or B.

2.2 Format Changing**To change from Format A to Format B**

S-FWR[0]- FAC[0]-D[0] → FWR[1]- FAC[1]- D[1] → FWR[2]- FAC[2]- D[2] → FAC[3]- D[3] → FAC[4]- D[4] → FAC[5]- D[5]...

The F bit from the FAC byte is always 0 in this case.

To change from Format A to Format C

S - FWR[0]- FAC[0]- D[0] → FWR[1]- FAC[1]- D[1] → FWR[2]- FAC[2]- D[2] → D[3] → D[4] → D[5]...

The "F" bit from the FAC byte is as follows:

F[0] = F[1] = "0"

F[2] = "1"

To change from Format B to Format A

S - FWR[0]- FAC[0]-D[0] → FAC[1]- D[1] → FAC[2]-D[2] → FWR[3]- FAC[3]- D[3] → FWR[4]- FAC[4]- D[4]...

The F bit from the FAC byte is always 0 in this case.

To change from Format B to Format C

S - FWR[0]- FAC[0]- D[0] → FAC[1]- D[1] → FAC[2]- D[2] → D[3] → D[4]...

The “F” bit from the FAC byte is as follows: F[0] = F[1] = “0” and F[2] = “1”

It is not possible to change from Format C back to Format A or B.

Figure 4: Format Changing Sequences

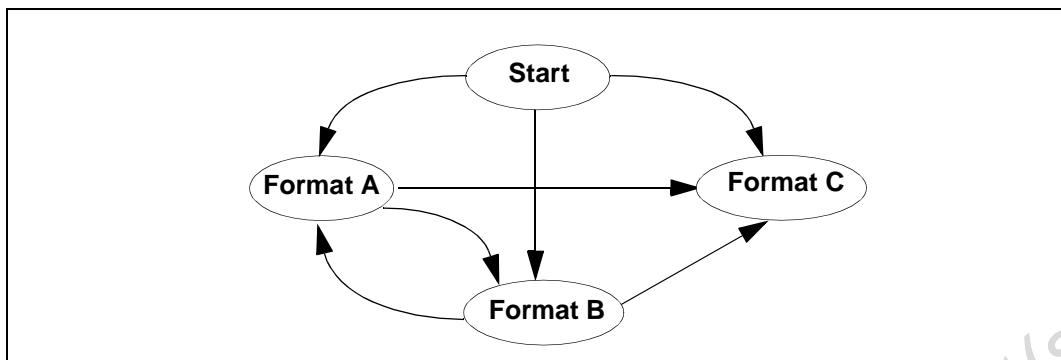

2.3 Read Mode

The transmission format is shown as below:

Start - S(w) - FWR- FAC - Stop - Start - S(r) - D → D → D → D...Stop

Where:

S(w) = Slave address in write mode = BAh = 10111010,

S(r) = Slave address in read mode = BBh = 10111011.

Registers and data in RAM are readable.

This mode is useful when developing OSD applications.

2.4 Addressing Map

Table 4: Window Addressing Map

Window	Row	Column	Data
Window 0	Row 0	Columns 0 to 31	Control Data (8 bits)
Window 0	Row 1	Columns 0 to 31	Reserved (Do Not Write)
Window 0	Row 2	Columns 0 to 31	Color-boxes (8 bits)
Windows 1, 2, 3 and 4	Rows 0 to n (n = 15 max.)	Columns 0 to m (m = 31 max.)	Characters Coding (11 bits)

3 Window Specifications

Four different independent windows with separate character displays can be simultaneously displayed on screen. It is possible to have overlapping windows with an automatic control of display priorities: downscale priorities from Window 4 to Window 1.

Window 1 is well-adapted for the OSD general menu.

The 4 windows, each with its own character display, can be positioned anywhere on the screen.

The following characteristics are defined for each window:

- Enable Display
- Position
- Size, adjustable with memory allocation
- Background Color
- Bordering or Shadowing effects with programmable color, height and width.

Figure 5: Example of Window Displays

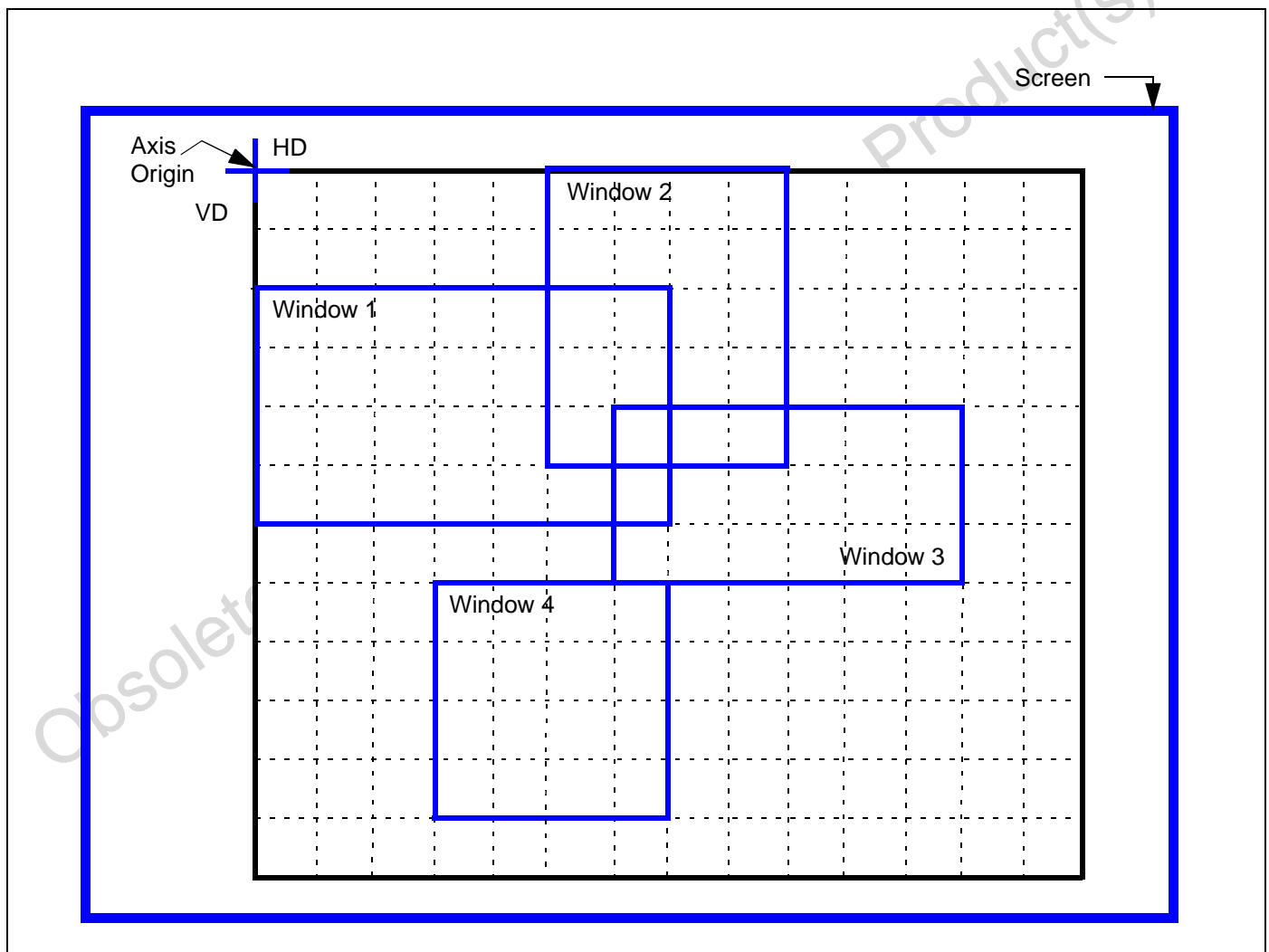

3.1 Enable Display

The Enable Display command for each window is selected by bits ENW1, ENW2, ENW3 and ENW4. If the ENWi bit is set to 1, the corresponding window is displayed.

Table 5: Enable Display

FWR	FAC	Default	Bit 7	Bit 6	Bit 5	Bit 4	Bit 3	Bit 2	Bit 1	Bit 0
80h	07h	0h					ENW4	ENW3	ENW2	ENW1

3.2 Origin Positions for the 4 Windows

The 4 windows are arranged in a vertical frame whose origin coordinates are the horizontal delay (HD) and the vertical delay (VD) located at the upper left-hand corner of the monitor screen. When the HD and VD values are changed, the 4 windows within the frame position are automatically shifted by the same value. The origin (HD, VD) can be programmed anywhere on the screen. Adjusting the origin position is used to globally reposition the OSD windows.

The advantages of this system are easier programming, the possibility to adapt the position of all windows at a single time without changing the relative position of each window and the possibility for the user to program all 4 window positions.

3.2.1 General Horizontal Delay (HD)

Table 6: Origin of Windows on Horizontal Axis: Horizontal Delay

FWR	FAC	Default	Bit 7	Bit 6	Bit 5	Bit 4	Bit 3	Bit 2	Bit 1	Bit 0
80h	04h	0h								HD[6:0]

The general horizontal delay defines the horizontal position of the origin coordinate for all four OSD windows. The horizontal delay is selected by bits HD[6:0]. A general horizontal offset is also applied:

$$\text{General Horizontal Offset} = 50 \text{ pixels} - \text{Phase Error Detection Pulse Width (in pixels)}$$

The range of the horizontal delay is from 50 to 812 pixels, in steps of 6 pixels each.

$$\text{General Horizontal Delay} = \text{HD}[6:0] \times 6 \text{ pixels} + \text{General Offset (in pixels)}$$

The default value is 0h (left-hand side of the monitor screen).

3.2.2 General Vertical Delay (VD)

Table 7: Origin of Windows on Vertical Axis: Vertical Delay

FWR	FAC	Default	Bit 7	Bit 6	Bit 5	Bit 4	Bit 3	Bit 2	Bit 1	Bit 0
80h	05h	0h								VD[7:0]

The general vertical delay defines the vertical position of the origin coordinate for all four OSD windows. The vertical delay is selected by bits VD[7:0]. A general vertical offset of 2 scan lines is also applied.

The range of the vertical delay is from 2 to 1022 scan lines, in steps of 4 scan lines each.

$$\text{General Vertical Delay} = \text{VD}[7:0] \times 4 + 2$$

The default value is 0h (top of screen).

3.3 Window Positions in the Frame

All values are referenced to the origin coordinates (HD, VD). For more information, refer to [Figure 5 on page 12](#).

3.3.1 Window Horizontal Delay

The window horizontal delay defines the horizontal start position for each separate OSD window. This value is selected by bits HDW1[6:0], HDW2[6:0], HDW3[6:0] and HDW4[6:0], respectively.

Table 8: Window Horizontal Delay

FWR	FAC	Default	Bit 7	Bit 6	Bit 5	Bit 4	Bit 3	Bit 2	Bit 1	Bit 0
80h	0Ch, 11h, 16h, 1Bh	0h, 20h, 0h, 10h								HDWi[6:0]

The range of the window horizontal delay is from 0 to 1524 pixels, in steps of 12 pixels each.

$$\text{Window Horizontal Delay} = \text{HDWi}[6:0] \times 12 \text{ pixels}$$

The total horizontal delay of a window is:

$$\text{General Horizontal Delay} + \text{HDWi}[6:0] \times 12 \text{ pixels; or,}$$

$$\text{HD}[6:0] \times 6 \text{ pixels} + \text{HDWi}[6:0] \times 12 \text{ pixels} + (50 \text{ pixels} - \text{Phase Error Detection Pulse Width}).$$

The default values for the window horizontal delay for each of the four OSD windows is given in [Table 8](#).

3.3.2 Window Vertical Delay

The window vertical delay defines the vertical start position for each separate OSD window. This value is selected by bits VDW1[5:0], VDW2[5:0], VDW3[5:0] and VDW4[5:0], respectively.

Table 9: Window Vertical Delay

FWR	FAC	Default	Bit 7	Bit 6	Bit 5	Bit 4	Bit 3	Bit 2	Bit 1	Bit 0
80h	0Dh, 12h, 17h, 1Ch	0h, 0h, Ch, Ch								VDWi[5:0]

The range of the window vertical delay is from 0 to 63 rows of characters, in steps of 1 character row each. It is important to note that the height of each character row is defined by the row height parameter. For more information, refer to [Section 4.4: Row Height \(Space Lines\) on page 20](#).

$$\text{Window Vertical Delay} = \text{VDWi}[5:0] \times \text{Row_Height}$$

The total vertical delay of a window is:

$$\text{General Vertical Delay} + \text{VDWi}[5:0] \times \text{Row_Height (in scan lines); or,}$$

$$(\text{VD}[7:0] \times 4 + 2) + \text{VDWi}[5:0] \times \text{Row_Height (in scan lines)}.$$

The default values for the window vertical delay for each of the four OSD windows is given in [Table 9](#).

3.4 Window Size: Number of Character Rows and Character Columns

3.4.1 Window Horizontal Size

The window horizontal size defines the number of characters displayed for character row for each separate OSD window. This value is selected by bits HSW1[4:0], HSW2[4:0], HSW3[4:0] and HSW4[4:0], respectively.

Table 10: Window Horizontal Size

FWR	FAC	Default	Bit 7	Bit 6	Bit 5	Bit 4	Bit 3	Bit 2	Bit 1	Bit 0	
80h	0Eh, 13h, 18h, 1Dh	19h, 9h, Fh, Fh					HSWi[4:0]				

The range of the window horizontal size is from 1 to 32 characters, in steps of 1 character each. Each character is 12 pixels long. There is an offset of 1 character.

$$\text{Window Horizontal Size} = \text{HSWi}[4:0] + 1 \text{ characters}$$

The default values for the window horizontal size for each of the four OSD windows is given in [Table 10](#).

3.4.2 Window Vertical Size

The window vertical size defines the number of character rows displayed for each separate OSD window. This value is selected by bits VSW1[3:0], VSW2[3:0], VSW3[3:0] and VSW4[3:0], respectively.

Table 11: Window Vertical Size

FWR	FAC	Default	Bit 7	Bit 6	Bit 5	Bit 4	Bit 3	Bit 2	Bit 1	Bit 0	
80h	0Fh, 14h, 19h, 1Eh	Bh, 4h, 7h, 7h					VSWi[3:0]				

The range of the window vertical size is from 1 to 16 character rows, in steps of 1 character row each. It is important to note that the height of each character row is defined by the row height parameter. For more information, refer to [Section 4.4: Row Height \(Space Lines\) on page 20](#). There is an offset of 1 character row.

$$\text{Window Vertical Size} = (\text{VSWi}[3:0] + 1) \times \text{Row_Height (in scan lines)}$$

$$\text{Row_Height} = \text{Character_Height} + 2 \times \text{Space_Lines}$$

The default values for the window vertical size for each of the four OSD windows is given in [Table 11](#).

Table 12 shows an example of the origin and size of windows based on the example shown in Figure 5,

Table 12: Example of Origin and Size of Windows

Window i	HD	VD	HSWi	VSWi
Window 1	0	2	7	4
Window 2	5	0	4	5
Window 3	6	4	6	3
Window 4	3	7	4	4

3.5 Window Background Color

The window background color for each separate OSD window is coded over 4 bits as shown in Table 13. The first bit (Ti) specifies whether the background is transparent or if a color is displayed.

If the background is transparent (Ti = 1), the active video is displayed as background.

If a color is displayed (Ti = 0), the background color for each separate OSD window is coded over the last three bits (RWi, GWi and BWi, respectively). Windows are displayed with a white background by default (7h).

Table 13: Background Color of Each Window

FWR	FAC	Default	Bit 7	Bit 6	Bit 5	Bit 4	Bit 3	Bit 2	Bit 1	Bit 0
80h	10h, 15h 1Ah, 1Fh	7h, 7h, 7h, 7h					Ti	RWi	GWi	BWi

3.6 Window Bordering and Shadowing Effects

3.6.1 Enable Bordering or Shadowing Effects

Bordering or shadowing effects are enabled for each separate OSD window by bits ENBS1, ENBS2, ENBS3 and ENBS4, respectively.

3.6.2 Bordering or Shadowing Selection

Either the bordering or the shadowing effect is selected for each separate OSD window by bits BSW1, BSW2, BSW3 and BSW4, respectively.

Table 14: Bordering and Shadowing Parameter Selection

Bit	Description
ENBSi	0: No Bordering, No Shadowing (Default Value) 1: Bordering or Shadowing is selected.
BSWi	0: Bordering is selected (Default Value) 1: Shadowing is selected.

Table 15: Enable Bordering or Shadowing Effects

FWR	FAC	Default	Bit 7	Bit 6	Bit 5	Bit 4	Bit 3	Bit 2	Bit 1	Bit 0
80h	07h	0h	ENBS4	ENBS3	ENBS2	ENBS1				
80h	10h, 15h 1Ah, 1Fh	0h, 0h, 0h, 0h				BSWi				

3.6.3 Border or Shadow Color

The border or shadow color is separately programmable for each separate OSD window. This value is selected by bits WSRi, WSGi and WSBi for each of the four OSD windows. The value for each color is shown in Table 17.

Table 16: Border or Shadow Color

FWR	FAC	Default	Bit 7	Bit 6	Bit 5	Bit 4	Bit 3	Bit 2	Bit 1	Bit 0
80h	10h, 15h 1Ah, 1Fh	0h, 0h, 0h, 0h	WSRi	WSGi	WSBi					

Table 17: Bordering and Shadowing Color Selection (WSRGBi)

Value	Color	Value	Color
000	Black (Default)	100	Red
001	Blue	101	Magenta
010	Green	110	Yellow
011	Cyan	111	White

3.6.4 Bordering or Shadowing Size

The size of the bordering or shadowing width is separately programmable for each separate OSD window. This value is selected by bits BSWWi[2:0] for each of the four OSD window. The width size is from 0 to 14 pixels, in steps of 2 pixels each.

$$\text{Width Size} = \text{BSWWi}[2:0] \times 2 \text{ pixels}$$

The size of the bordering or shadowing height is selected by bits BSHWi[3:0] for each of the four windows. The height size is from 0 to 30 lines, in steps of 2 scan lines each.

$$\text{Height Size} = \text{BSHWi}[3:0] \times 2 \text{ scan lines.}$$

Table 18: Bordering or Shadowing Size

FWR	FAC	Default	Bit 7	Bit 6	Bit 5	Bit 4	Bit 3	Bit 2	Bit 1	Bit 0
80h	0Eh, 13h 18h, 1Dh	0h, 0h, 0h, 0h	BSWWi[2:0]							
80h	0Fh, 14h 19h, 1Eh	0h, 0h, 0h, 0h	BSHWi[3:0]							

Figure 6: Illustration of Window Bordering and Shadowing Effects

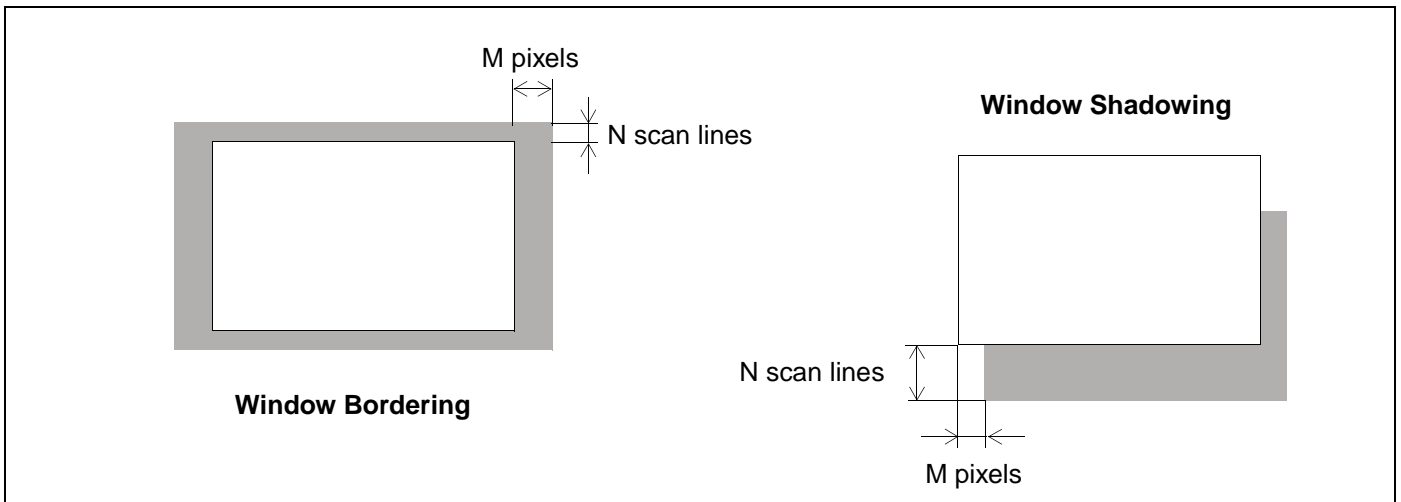

3.7 Window Display Priority Management

The OSD windows are displayed with the following priority: Window 4 (top), 3, 2 and 1 (bottom).

This order of priority is shown the example given in Figure 7.

Figure 7: Example of Window Displays

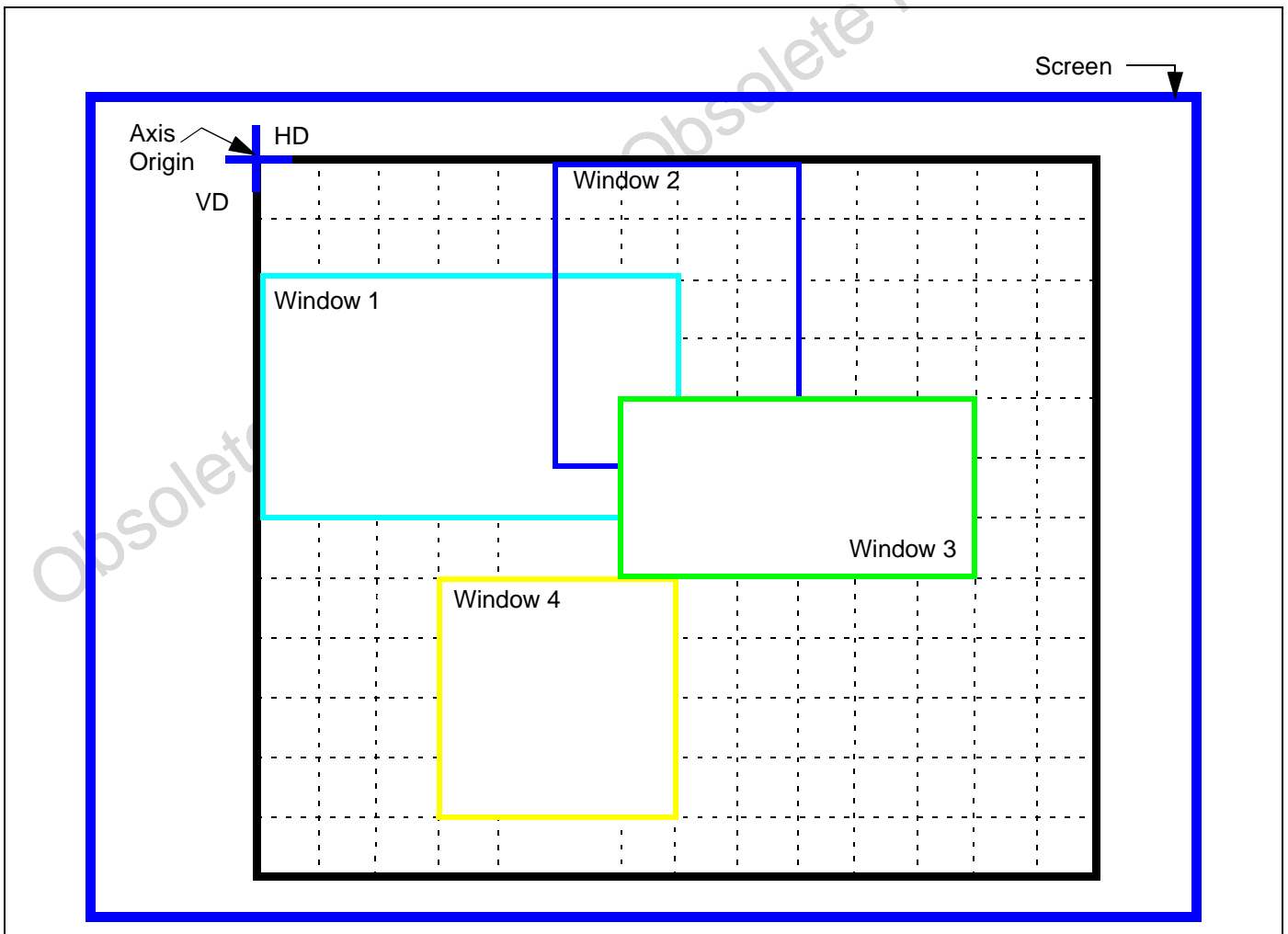

4 Character Specifications

4.1 General Description

There are:

- 256 monochrome characters and 16 multi-color characters in ROM
- 32 to 127 characters per line
- character height varies between 18 and 127 scan lines
- 0 to 62 scan space lines between character rows, with the same number of lines above and below the rows of characters.

With the possibility to select:

- blinking effect for each character
- shadowing effect for characters in each window
- background and foreground character colors: for each character, among a Color-shop of 8 Color-boxes per window. There is a Color-shop for each window. The Color-boxes define the background colors and the foreground character colors and blinking effect.

4.2 Horizontal Resolution

Table 19: Horizontal Resolution

FWR	FAC	Default	Bit 7	Bit 6	Bit 5	Bit 4	Bit 3	Bit 2	Bit 1	Bit 0
80h	01h	20h								HR[6:0]

The horizontal resolution defines the number of pixels per line expressed in characters unit. This value is selected by bits HR[6:0].

The range of the horizontal resolution is from 32 to 127 characters, in steps of one character. The default value is 32 characters per line (20h). If bits HR[6:0] are programmed with a value less than 32, the horizontal resolution will be 32 characters per line (minimum value).

$$\text{HR}[6:0] = \text{Number of characters per line}$$

It is important that the maximum pixel frequency must be respected ($f_{\text{PIXEL}} = 120 \text{ MHz}$ maximum). As each character is 12 pixels long, the number of pixels per line varies from 384 to 1524. For more information, refer to [Section 6: Pixel Clock Generator on page 31](#).

4.3 Character Height

Table 20: Vertical Character Height

FWR	FAC	Default	Bit 7	Bit 6	Bit 5	Bit 4	Bit 3	Bit 2	Bit 1	Bit 0
80h	02h	12h								CH[6:0]

The vertical height defines the number of scan lines used to display the characters. This value is selected by bits CH[6:0].

The range of the vertical height is from 18 to 127 lines.

CH[6:0] = Number of scan lines used to display the characters

The characters stored in ROM are coded on 18 lines. If bits CH[6:0] are programmed with a value less than 18, the characters will be automatically displayed with a height of 18 scan lines (minimum value).

When a multiple of 18 scan lines are displayed, all ROM lines are repeated N number of times, with N in the range of 1 to 7, so as not to exceed the display of 127 scan lines. For example, if CH[6:0] = 36, each ROM line is repeated twice.

If the number of scan lines displayed is not a multiple of 18, certain ROM lines are repeated more often than others, as shown in [Table 21](#). For example, if CH[6:0] = 40, each ROM line is repeated twice and ROM lines 3, 7, 10 and 14 are repeated three times.

[Table 21](#) shows which ROM lines, from 0 to 17, are repeated depending on the CH[6:0] value.

Table 21: Repeated ROM Lines¹

CH Value	A	0	1	2	3	4	5	6	7	8	9	10	11	12	13	14	15	16	17	
18, 36, 54, 72, 90, 108, 126	0																			
19, 37, 55, 73, 91, 109, 127	1									R										
20, 38, 56, 74, 92, 110,	2						R							R						
21, 39, 57, 75, 93, 111	3					R				R					R					
22, 40, 58, 76, 94, 112	4					R				R			R				R			
23, 41, 59, 77, 95, 113	5				R			R			R			R				R		
24, 42, 60, 78, 96, 114	6		R				R			R			R			R			R	
25, 43, 61, 79, 97, 115	7	R				R			R		R			R			R		R	
26, 44, 62, 80, 98, 116	8		R			R			R			R		R			R		R	
27, 45, 63, 81, 99, 117	9		R				R			R			R		R			R		R
28, 46, 64, 82, 100, 118	10	R			R			R			R		R			R			R	R
29, 47, 65, 83, 101, 119	11		R		R			R		R			R		R			R		R
30, 48, 66, 84, 102, 120	12	R			R		R		R		R		R		R			R		R
31, 49, 67, 85, 103, 121	13	R	R			R		R		R		R		R		R			R	R
32, 50, 68, 86, 104, 122	14	R	R		R		R		R		R		R		R			R		R
33, 51, 69, 87, 105, 123	15	R	R		R		R		R		R		R		R			R		R
34, 52, 70, 88, 106, 124	16		R		R		R		R		R		R		R			R		R
35, 53, 71, 89, 107, 125	17		R		R		R		R		R		R		R			R		R

1. 'R' = Repeated ROM lines

'A' = Number of additional repeated lines

4.4 Row Height (Space Lines)

The row height defines the number of scan lines above and below each character row. This value is selected by bits RSPA[4:0]. The total row height is defined as follows:

Row_Height = Character_Height + 2 x Space_Lines (see [Figure 8](#))

The range of spacing lines for the row height is from 0 to 31 scan lines, in steps of one scan line each. Accordingly, the number of scan lines between each character row is multiplied by two; the bottom space line of a given character row being added to the top space line of the following character row. The default value is 0 scan lines.

The space lines are displayed in the color of the associated character background.

Table 22: Row Height (Space Lines)

FWR	FAC	Default	Bit 7	Bit 6	Bit 5	Bit 4	Bit 3	Bit 2	Bit 1	Bit 0
80h	03h	0h				RSPA[4:0]				

Figure 8: Row Height Definition

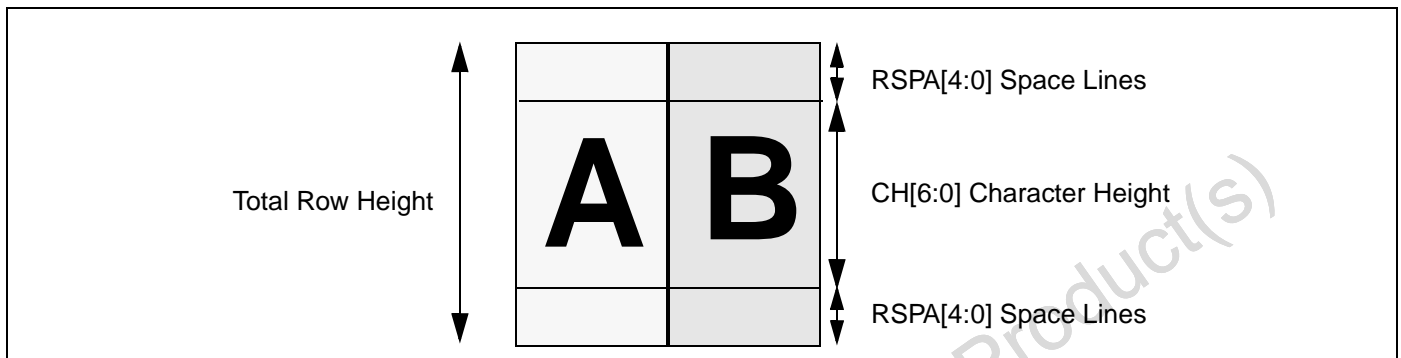

4.5 Character Colors

The colors for the characters, character background and blinking effect are separately programmable for each OSD window. The color values are stored in a color-shop of 8 color-boxes for each window. There are 4 color-shops, 1 per window, offering the user 32 possibilities of character coloring.

As the color-boxes are in RAM, the user must write to the color-box prior to using it.

Color-box data is stored in Window 0, Row 2. For more information, refer to [Section 2.4: Addressing Map on page 11](#).

Table 23: color-box

FWR	FAC	Default	Bit 7	Bit 6	Bit 5	Bit 4	Bit 3	Bit 2	Bit 1	Bit 0
82h	00h to 1Fh		BC	BR	BG	BB	BLINK	FR	FG	FB

4.5.1 Character Background Color

A character background color can be separately programmed for each of the four color-boxes. This value is selected by bits BC, BR, BG and BB.

Bit BC is used to define if a specific character background color will be displayed or if the character background color is the color of the window background.

If a specific character background color is selected in a color box, the character background color is selected by bits BR, BG and BB.

Table 24: Character Background Color

Color	BC	BR	BG	BB
Black	1	0	0	0
Blue	1	0	0	1
Green	1	0	1	0
Cyan	1	0	1	1
Red	1	1	0	0
Magenta	1	1	0	1
Yellow	1	1	1	0
White	1	1	1	1
Window Background Color ¹	0			

1. See [Table 25](#)

Table 25: Background Color Priority

BC	TI	Background Color
1	X	Character Background Color (BR, BG and BB)
0	0	Window Background Color (RGBWi)
0	1	Transparent Background (Video active)

4.5.2 Character Color

A character color can be separately programmed for each of the color-boxes. This value is selected by bits FR, FG and FB.

Table 26: Character Colors

Color	FR	FG	FB
Black	0	0	0
Blue	0	0	1
Green	0	1	0
Cyan	0	1	1
Red	1	0	0
Magenta	1	0	1
Yellow	1	1	0
White	1	1	1

4.5.3 Character Blinking Effect

A character blinking effect can be programmed for each of the color boxes. This value is selected by the BLINK bit. When this bit is set to 1, the blinking effect is enabled and the characters blink.

4.6 Multicolor Characters

16 multicolor characters can be separately programmed for each of the color-boxes. These special characters are stored in the character font (see [Figure 10](#)) and are selected by bits MCOLOR[3:0].

MCOLOR[3] for Window 4

MCOLOR[2] for Window 3

MCOLOR[1] for Window 2

MCOLOR[0] for Window 1

If the MCOLOR bit is set to 0 for a specific color-box, the 256 monochrome ROM characters from \$00 to \$FF are available (default value).

If the MCOLOR bit is set to 1, the 240 monochrome ROM characters from \$00 to \$EF and the 16 multicolor characters from \$F0 to \$FF are available.

No shadowing effects on multicolor characters.

No background effects on multicolor characters.

Blinking on multicolor characters: background color coded in the associated color-box.

Table 27: Multicolor Characters

FWR	FAC	Default	Bit 7	Bit 6	Bit 5	Bit 4	Bit 3	Bit 2	Bit 1	Bit 0	
80h	08h	0h	MCOLOR[3:0]								

4.7 Character Shadowing

A character shadowing effect can be separately programmed for each of the four color-boxes. This value is selected by bits CSHA[3:0], respectively. The shadowing color is black.

When this bit is set to 1, the characters of the corresponding OSD window are displayed with a shadowing effect, as shown in [Figure 9](#). The default value is 0 (no shadowing effect).

Figure 9: Character Shadowing

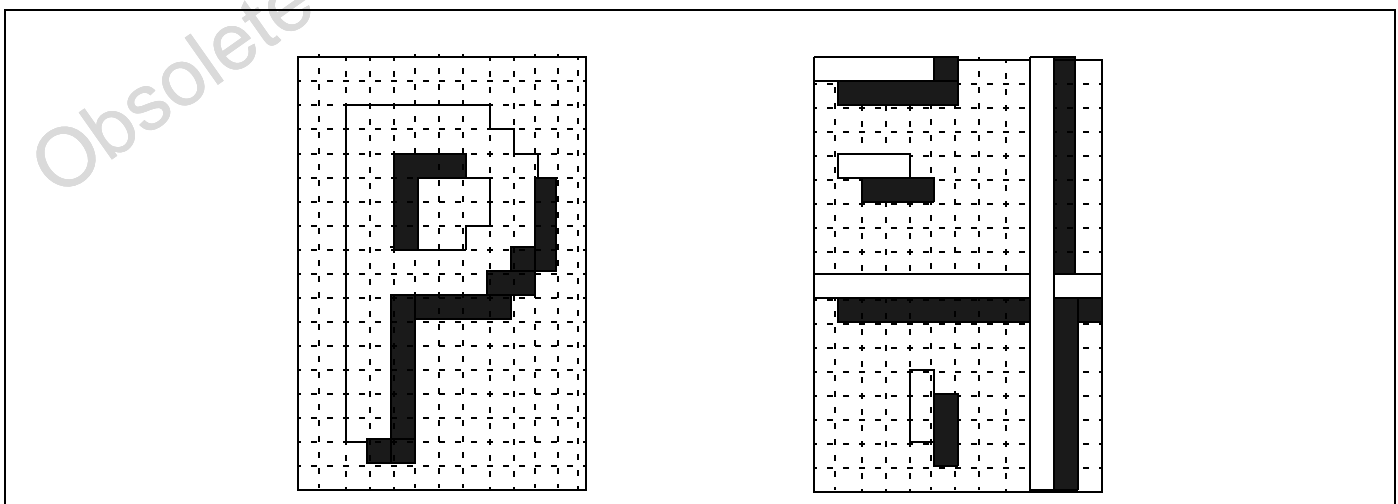

Table 28: Character Shadowing

FWR	FAC	Default	Bit 7	Bit 6	Bit 5	Bit 4	Bit 3	Bit 2	Bit 1	Bit 0
80h	08h	0h								CSHA[3:0]

4.8 Character Font

Figure 10 shows the available character font stored in ROM. For more information concerning the display of mono- or multi-color characters, refer to Section 4.6: Multicolor Characters.

Figure 10: /AA Character Fonts

	0	1	2	3	4	5	6	7	8	9	A	B	C	D	E	F
0		A	B	C	D	E	F	G	H	I	J	K	L	M	N	O
1	P	Q	R	S	T	U	V	W	X	Y	Z	→	←	↓	↑	β
2	0	1	2	3	4	5	6	7	8	9	Ä	Å	Ã	Ä	Ë	Ë
3	ï	ö	õ	õ	ø	ñ	ü	û	æ	œ	.	:	?	!	()
4	/	a	b	c	d	e	f	g	h	i	j	k	l	m	n	o
5	p	q	r	s	t	u	v	w	x	y	z	ä	å	ã	é	ë
6	ê	î	ö	õ	ø	ñ	ü	û	æ	œ	ç	+	-	温	对	
7	比	度	亮	行	场	幅	相	位	枕	桶	形	梯	平	四	边	缩
8	放	旋	转	波	纹	按	键	还	原	退	出	消	磁	调	恢	复
9	红	蓝	绿	斜	用	户	频	率	模	式	保	存	进	入	色	声
A	●	☉	☺	☺	☺	☺	☺	☺	☺	☺	☺	☺	☺	☺	☺	☺
B	☺	☺	☺	☺	☺	☺	☺	☺	☺	☺	☺	☺	☺	☺	☺	☺
C	[Progressive bars and symbols]															
D	☺	☺	☺	☺	☺	☺	☺	☺	☺	☺	☺	☺	☺	☺	☺	☺
E	△	▽	◊	○	□	□	□	□	□	□	□	□	□	□	□	□
F	□	□	□	□	□	□	□	□	□	□	□	□	□	□	□	□
Mono																
Multi																
F	MENU	☺	☺	☺	☺	☺	☺	☺	☺	☺	☺	☺	☺	☺	☺	☺

Figure 11: /AB Character Fonts

	0	1	2	3	4	5	6	7	8	9	A	B	C	D	E	F
0		A	B	C	D	E	F	G	H	I	J	K	L	M	N	O
1	P	Q	R	S	T	U	V	W	X	Y	Z	→	←	↓	↑	主
2	0	1	2	3	4	5	6	7	8	9	离	时	倾	上	设	水
3	线	下	直	修	颜	言	语	预	正	置	.	:	?	!	()
4	/	a	b	c	d	e	f	g	h	i	j	k	l	m	n	o
5	p	q	r	s	t	u	v	w	x	y	z	菜	垂	重	单	高
6	弓	汉	化	回	开	机	间	校	焦	角	聚	烤	+	-	温	对
7	比	度	亮	行	场	幅	相	位	枕	桶	形	梯	平	四	边	缩
8	放	旋	转	波	纹	按	键	还	原	退	出	消	磁	调	灰	复
9	红	蓝	绿	斜	用	户	频	率	模	式	保	存	进	入	色	宽
A	●	☉	°	老	⊕	⊖	☰	☷	⚡	⚡	⚡	⚡	⚡	⚡	⚡	⚡
B	⚡	⚡	⚡	⚡	⚡	⚡	⚡	⚡	⚡	⚡	⚡	⚡	⚡	⚡	⚡	⚡
C	[Progressive Bar]															🔊
D	⊕	⊕	⊕	⊕	⊕	⊕	⊕	⊕	⊕	⊕	⊕	⊕	⊕	⊕	⊕	⊕
E	△	▽	◊	○	□	□	□	□	□	□	□	□	□	□	□	□
Mono F	□	□	□	□	□	□	□	□	□	□	□	□	□	□	□	□
Multi F	MENU	⚡	⚡	⚡	⚡	⚡	⚡	⚡	⚡	⚡	⚡	⚡	⚡	⚡	⚡	⚡

Figure 12: /AC Character Fonts



5 RAM Specification

5.1 Character Coding

Each character to display is coded with 11 bits in the RAM with the following addressing method:

- Character Code: Bits RC[7:0] are used to address the ROM Code
- Color Code: Bits CB[2:0] are used to select 1 of the 8 color-boxes in the color shop of the corresponding OSD window.

Table 29: Character Coding

FWR	FAC	Bit 10	Bit 9	Bit 8	Bit 7	Bit 6	Bit 5	Bit 4	Bit 3	Bit 2	Bit 1	Bit 0
See Table 3		CB[2:0]			RC[7:0]							

5.2 Window Memory Allocation

The 4 OSD windows can be distributed differently. But the displayable windows will always contain a total of 22 blocks (1 block consists of 32 characters).

Figure 13: Window Memory Space

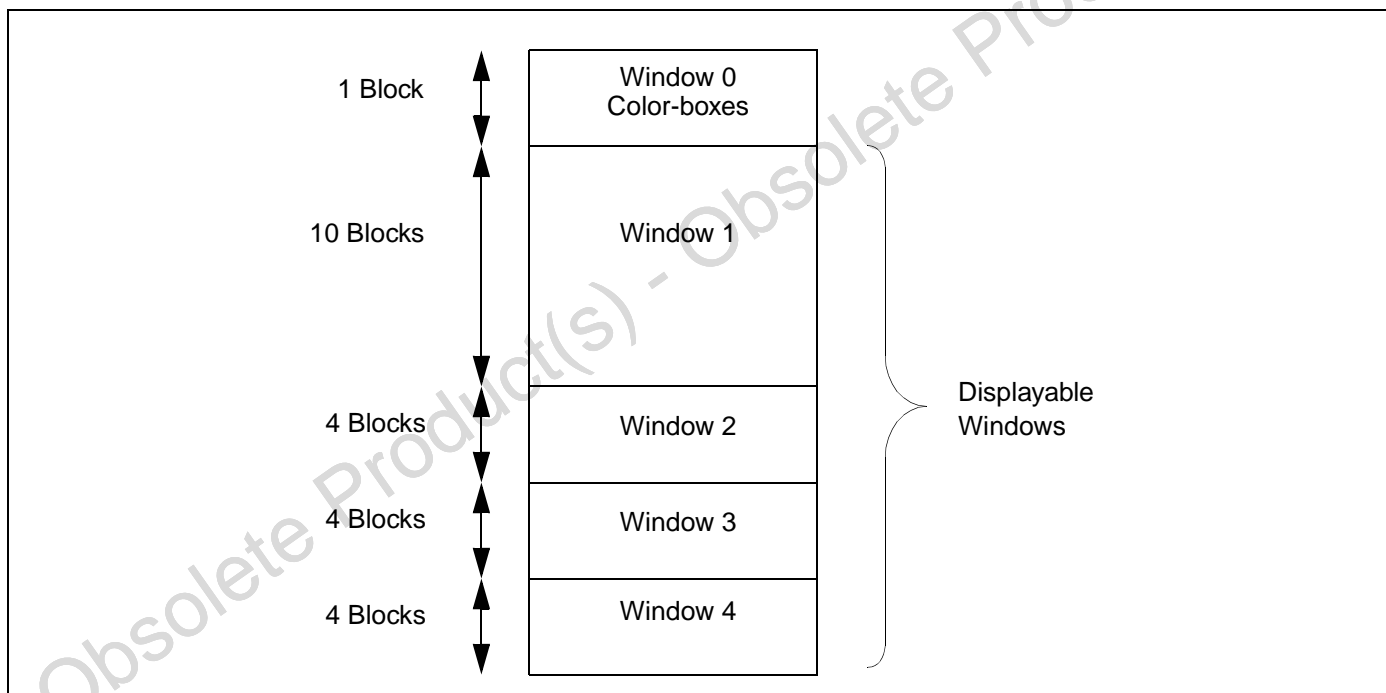

5.3 Memory Size Allocation

The total number of characters or spaces is up to 704 with a maximum window size of 16 rows of 32 characters.

The character codes of each window are allocated to a specific memory space. This memory space is programmable for each window. The window size must be less than or equal to its memory allocation. Any window size can be modified within its specific memory space, the other windows are not affected by this operation.

The user must reserve a memory space for the largest window. According to the example shown in [Figure 5](#), the total number of characters/spaces are:

Table 30: Window Sizes

Window	Size
Window 1	28
Window 2	20
Window 3	18
Window 4	16
Total	82

For example, to change the size of Window 3 from 3 rows of 6 characters to 5 rows of 4 characters, the resulting size is 20 characters. The number of rows increases and the number of characters per row decreases. The required memory is at least 20 characters.

Note: A space is considered as being a character.

The memory allocation is made by blocks of 32 characters.

The maximum size of a window is 16 rows of 32 characters, or 512 characters. This corresponds to 16 blocks of 32 characters.

1 block is reserved for the color-boxes (see [Chapter 4: Character Specifications on page 19](#)), leaving 22 blocks of 32 characters for character codes (704 characters maximum).

The RAM allocation for each window is coded in bits $ALW_i[3:0]$. Window 4 memory allocation uses the remaining memory space.

Table 31: Window RAM Allocation

FWR	FAC	Default	Bit 7	Bit 6	Bit 5	Bit 4	Bit 3	Bit 2	Bit 1	Bit 0
80h	09h	39h	ALW2[3:0]				ALW1[3:0]			
80h	0Ah	3h					ALW3[3:0]			

The number of memory blocks allocated for window “i” is $(ALW_i + 1)$, the range of allocation is 1 to 16 blocks of 32 characters. The total number of blocks is 22.

Note: If the user changes only 1 window allocation, the RAM addresses of the following windows change. Consequently we advise you to write the allocation when the windows are not displayed to avoid false images.

The default window RAM allocations are listed in [Table 32](#).

Table 32: Window RAM Default Values

ALWi	Default	Description
ALW1	9h	320 Characters (10 blocks)
ALW2	3h	128 Characters (4 blocks)
ALW3	3h	128 Characters (4 blocks)

Window 1: 10 blocks of 32 words = 320 characters (ALW1 = 9).

Window 2: 4 blocks of 32 words = 128 characters (ALW2 = 3).

Window 3: 4 blocks of 32 words = 128 characters (ALW3 = 3).

Window 4: the remaining RAM (4 blocks = 128 characters).

5.4 Window Reset

All the RAM data from one of the four OSD windows can be reset by writing to bits RESETW[3:0].

When the RESETW bit is set to 1, all the RAM data in the allocation memory space of the corresponding OSD window is reset. These bits are automatically cleared when the RAM allocation reset is finished.

All programmable registers are in Row 0 (Column i, Row 0).

Table 33: RAM Allocation Enable and Reset

FWR	FAC	Default	Bit 7	Bit 6	Bit 5	Bit 4	Bit 3	Bit 2	Bit 1	Bit 0
80h	0Bh	0h					RESETW[3:0]			

6 Pixel Clock Generator

The Pixel Clock Generator is used to synchronize the display clock with the horizontal flyback (HFLY) signal. This generator is based on a PLL function used to perform correct jitter. The pixel frequency is defined with the horizontal line frequency and the horizontal resolution.

$$\text{Pixel Frequency } (f_{\text{PIXEL}}) = 12 \times \text{HR}[6:0] \times f_{\text{HLINE}}$$

The VCO[1:0] value is used to select the appropriate curve partition of the VCO.

Table 34: VCO Curve Partition

VCO Value (Binary)	VCO Curve Partition
00	7.68 MHz < H _{PIXEL} < 15 MHz (Default Value)
01	15 MHz < H _{PIXEL} < 30 MHz
10	30 MHz < H _{PIXEL} < 60 MHz
11	60 MHz < H _{PIXEL} < 120 MHz

Table 35: VCO Range

FWR	FAC	Default	Bit 7	Bit 6	Bit 5	Bit 4	Bit 3	Bit 2	Bit 1	Bit 0
80h	00h	0h								VCO[1:0]

7 General OSD Programming

7.1 Enable OSD

The OSD window displays are enabled by the ENOSD bit.

ENOSD = 1: OSD window displays are active.

ENOSD = 0: OSD window displays are inactive. Pin FBLK = 0 and pins ROUT, GOUT and BOUT pins = 0 (bit RGBPOL is 0). The default value is 0.

Table 36: Enable OSD

FWR	FAC	Bit 7	Bit 6	Bit 5	Bit 4	Bit 3	Bit 2	Bit 1	Bit 0
80h	00h				ENOSD				

7.2 Fade-in and Fade-out Effect

The Fade-in and Fade-out effect is used to progressively increase/decrease the OSD window to/from its full size in just a few milliseconds. This effect is enabled by the FADE bit.

FADE = 1: Fade effect is active

FADE = 0: Fade effect is inactive (default value)

Table 37: Fade

FWR	FAC	Bit 7	Bit 6	Bit 5	Bit 4	Bit 3	Bit 2	Bit 1	Bit 0
80h	00h			FADE					

7.3 Full Screen Display

The STV9936 allows a full screen display with a selectable color programmable by the FBK bit as follows:

FBK = 1: The video area is replaced by the color coded in bits FSR, FSG and FSB (full screen color values). Pin FBLK is always 1.

FBK = 0: Normal video mode whether or not the OSD menu is displayed. The default value of bit FBK is 0.

Table 38: Full Screen Registers

FWR	FAC	Default	Bit 7	Bit 6	Bit 5	Bit 4	Bit 3	Bit 2	Bit 1	Bit 0
80h	01h	0h	FBK							
80h	03h	0h	FSR	FSG	FSB					

Table 39: Full Screen Colors

Color	FSR	FSG	FSB
Black (Default Value)	0	0	0
Blue	0	0	1
Green	0	1	0

Table 39: Full Screen Colors (Continued)

Color	FSR	FSG	FSB
Cyan	0	1	1
Red	1	0	0
Magenta	1	0	1
Yellow	1	1	0
White	1	1	1

7.4 Signal Polarity and Triggering

Table 40: Signal Polarity

FWR	FAC	Default	Bit 7	Bit 6	Bit 5	Bit 4	Bit 3	Bit 2	Bit 1	Bit 0
80	00		FBKPOL	RGBPOL			VSP	HSP		

Vertical Sync Triggering (VS input)

The active edge of the VS pin used for vertical synchronization is selected by bit VSP.

VSP = 0: The falling edge is active. (Default Value)

VSP = 1: The rising edge is active.

Horizontal Sync Triggering (HFLY input)

The active edge of the HFLY pin used for horizontal synchronization is selected by bit HSP.

HSP = 0: The falling edge is active. (Default Value)

HSP = 1: The rising edge is active.

RGB Output Polarity (ROUT, GOUT and BOUT outputs)

The output polarity of pins ROUT, GOUT and BOUT is selected by bit RGBPOL.

RGBPOL = 0: RGB active at 1 (Default Value)

RGBPOL = 1: RGB active at 0

Table 41: RGB Output Control

ENOSD Bit	RGBPOL Bit	RGB Outputs	Display
1	0	Active at 1	OSD
1	1	Active at 0	OSD
0	0	000	Video
0	1	111	Video

Fast Blanking Output Polarity (FBLK output)

The output polarity of the FBLK pin is selected by bit FBLKPOL. The default value is 0.

Table 42: Fast Blanking Output Polarity Selection

FBLKPOL	Description
0	When OSD display, FBLK = 1 When active video, FBLK = 0
1	When OSD display, FBLK = 0 When active video, FBLK = 1

Table 43: FBLK Output Control

ENOSD Bit	FBLKPOL Bit	FBK Bit	FBLK Output	Display	
1	0	0	0	Video	Default Value
1	0	0	1	OSD	
1	0	1	1	OSD	Full Screen
1	1	0	0	OSD	FBLK Inverted
1	1	0	1	Video	
1	1	1	0	OSD	Full Screen
0	0	x	0	Video	No OSD
0	1	x	1	Video	No OSD

7.5 Reset

Power On Reset

The digital core and the PLL are asynchronously reset at Power On.

Soft Reset

A soft reset is enabled by the RST bit.

RST = 1: The digital core is reset. All control registers, except PLL registers, are reset at the same value as at power on reset.

It is not necessary to write RST = 0 to stop the reset. This bit is automatically cleared.

PLL Register Reset

The Pixel Clock Generator (VCO[1:0]) and Horizontal Resolution (HR[6:0]) bits are reset by the RST_PLL bit.

RST_PLL = 1: HR[6:0] and VCO[1:0] are reset to the same value as the power-on reset.

It is not necessary to write RST_PLL = 0 to stop the reset. This bit is automatically cleared.

Table 44: Reset

FWR	FAC	Bit 7	Bit 6	Bit 5	Bit 4	Bit 3	Bit 2	Bit 1	Bit 0
80h	06h							RST_PLL	RST

8 Registers

8.1 Register Specification

Control registers are located at address in Window 0, Row 0.

Color-boxes are located at addresses in Window 0, Row 2. See [Section 4.5 on page 21](#).

Character codes are located at addresses in Windows 1 to 4, as described in [Section 5.1 on page 28](#).

Table 45: Non-Displayable Window Register Mapping

Register	Window	Row	FWR Code
Control Registers	0	0	80h
Reserved	0	1	DO NOT WRITE
Color-box Registers	0	2	82h

Table 46: Control Registers: Window 0, Row = 0

FWR	FAC	Col	Default	Bit 7	Bit 6	Bit 5	Bit 4	Bit 3	Bit 2	Bit 1	Bit 0		
80h	00h	0h	0h	FBKPOL = 0	RGBPOL = 0	FADE = 0	ENOSD = 0	VSP = 0	HSP = 0	VCO[1:0] = 00			
80h	01h	1h	20h	FBK = 0	HR[6:0] :Horizontal Resolution = 32 characters								
80h	02h	2h	12h		CH[6:0] = Character Height = 18								
80h	03h	3h	0h	full screen RGB = FS RGB = 000			RSPA[4:0] = Row Spacing = 0						
80h	04h	4h	0h	HD[6:0] = Horizontal Delay Reference = 0 (50 pixels)									
80h	05h	5h	0h	VD[7:0] = Vertical Delay Reference = 0 (2 lines)									
80h	06h	6h	0h							RST_PLL = 0	RST = 0		
80h	07h	7h	0h	ENBS4/3/2/1 = 0000				ENW4/3/2/1 = 0000					
80h	08h	8h	0h	MCOLOR4/3/2/1 = 0000				CSHA4/3/2/1 = 0000					
80h	09h	9h	39h	ALW2[3:0] = 3 (4 blocks = 128 characters)				ALW1[3:0] = 9 (10 blocks = 320 characters)					
80h	0Ah	Ah	2h					ALW3[3:0] = 3 (4 blocks = 128 characters)					
80h	0Bh	Bh	0h					RESETW4/3/2/1 = 0000					
80h	0Ch	Ch	0h		HDW1[6:0] = 0								
80h	0Dh	Dh	0h		VDW1[5:0] = 0								
80h	0Eh	Eh	19h	BSWW1[2:0] = 000			HSW1[4:0] = 25 (26 characters)						
80h	0Fh	Fh	Bh	BSHW1[3:0] = 0000				VSW1[3:0] = 11 (12 rows of characters)					
80h	10h	10h	7h	WS RGB 1 = 000 : black			BSW1=0	T1 = 0	RGB W1 = 111:white				
80h	11h	11h	20h		HDW2[6:0] = 32								
80h	12h	12h	0h		VDW2[5:0] = 0								
80h	13h	13h	9h	BSWW2[2:0] = 000			HSW2[4:0] = 9 (10 characters)						
80h	14h	14h	4h	BSHW2[3:0] = 0000				VSW2[3:0] = 4 (5 rows of characters)					
80h	15h	15h	7h	WS RGB 2 = 000 : black			BSW2=0	T2 = 0	RGB W2 = 111:white				
80h	16h	16h	0h		HDW3[6:0] = 0								
80h	17h	17h	Ch		VDW3[5:0] = 12								
80h	18h	18h	Fh	BSWW3[2:0] = 000			HSW3[4:0] = 15 (16 characters)						
80h	19h	19h	7h	BSHW3[3:0] = 0000				VSW3[3:0] = 7 (8 rows of characters)					
80h	1Ah	1Ah	7h	WS RGB 3 = 000 : black			BSW3=0	T3 = 0	RGB W3 = 111:white				
80h	1Bh	1Bh	10h		HDW4[6:0] = 16								
80h	1Ch	1Ch	Ch		VDW4[5:0] = 12								
80h	1Dh	1Dh	Fh	BSWW4[2:0] = 000			HSW4[4:0] = 15 (16 characters)						
80h	1Eh	1Eh	7h	BSHW4[3:0] = 0000				VSW4[3:0] = 7 (8 rows of characters)					
80h	1Fh	1Fh	7h	WS RGB 4 = 000 : black			BSW4=0	T4 = 0	RGB W4 = 111:white				

Table 47: Color Registers: Window 0, Row = 2

FWR	FAC	Col	Bit 7	Bit 6	Bit 5	Bit 4	Bit 3	Bit 2	Bit 1	Bit 0
82h	00h	0h	WINDOW1	Color-box 1: BC- BR-BG-BB-blink-FR-FG-FB						
82h	01h	1h	WINDOW1	Color-box 2: BC- BR-BG-BB-blink-FR-FG-FB						
82h	02h	2h	WINDOW1	Color-box 3: BC- BR-BG-BB-blink-FR-FG-FB						
82h	03h	3h	WINDOW1	Color-box 4: BC- BR-BG-BB-blink-FR-FG-FB						
82h	04h	4h	WINDOW1	Color-box 5: BC- BR-BG-BB-blink-FR-FG-FB						
82h	05h	5h	WINDOW1	Color-box 6: BC- BR-BG-BB-blink-FR-FG-FB						
82h	06h	6h	WINDOW1	Color-box 7: BC- BR-BG-BB-blink-FR-FG-FB						
82h	07h	7h	WINDOW1	Color-box 8: BC- BR-BG-BB-blink-FR-FG-FB						
82h	08h	8h	WINDOW2	Color-box 1: BC- BR-BG-BB-blink-FR-FG-FB						
82h	09h	9h	WINDOW2	Color-box 2: BC- BR-BG-BB-blink-FR-FG-FB						
82h	1Ah	Ah	WINDOW2	Color-box 3: BC- BR-BG-BB-blink-FR-FG-FB						
82h	1Bh	Bh	WINDOW2	Color-box 4: BC- BR-BG-BB-blink-FR-FG-FB						
82h	1Ch	Ch	WINDOW2	Color-box 5: BC- BR-BG-BB-blink-FR-FG-FB						
82h	1Dh	Dh	WINDOW2	Color-box 6: BC- BR-BG-BB-blink-FR-FG-FB						
82h	1Eh	Eh	WINDOW2	Color-box 7: BC- BR-BG-BB-blink-FR-FG-FB						
82h	1Fh	Fh	WINDOW2	Color-box 8: BC- BR-BG-BB-blink-FR-FG-FB						
82h	10h	10h	WINDOW3	Color-box 1: BC- BR-BG-BB-blink-FR-FG-FB						
82h	11h	11h	WINDOW3	Color-box 2: BC- BR-BG-BB-blink-FR-FG-FB						
82h	12h	12h	WINDOW3	Color-box 3: BC- BR-BG-BB-blink-FR-FG-FB						
82h	13h	13h	WINDOW3	Color-box 4: BC- BR-BG-BB-blink-FR-FG-FB						
82h	14h	14h	WINDOW3	Color-box 5: BC- BR-BG-BB-blink-FR-FG-FB						
82h	15h	15h	WINDOW3	Color-box 6: BC- BR-BG-BB-blink-FR-FG-FB						
82h	16h	16h	WINDOW3	Color-box 7: BC- BR-BG-BB-blink-FR-FG-FB						
82h	17h	17h	WINDOW3	Color-box 8: BC- BR-BG-BB-blink-FR-FG-FB						
82h	18h	18h	WINDOW4	Color-box 1: BC- BR-BG-BB-blink-FR-FG-FB						
82h	19h	19h	WINDOW4	Color-box 2: BC- BR-BG-BB-blink-FR-FG-FB						
82h	1Ah	1Ah	WINDOW4	Color-box 3: BC- BR-BG-BB-blink-FR-FG-FB						
82h	1Bh	1Bh	WINDOW4	Color-box 4: BC- BR-BG-BB-blink-FR-FG-FB						
82h	1Ch	1Ch	WINDOW4	Color-box 5: BC- BR-BG-BB-blink-FR-FG-FB						
82h	1Dh	1Dh	WINDOW4	Color-box 6: BC- BR-BG-BB-blink-FR-FG-FB						
82h	1Eh	1Eh	WINDOW4	Color-box 7: BC- BR-BG-BB-blink-FR-FG-FB						
82h	1Fh	1Fh	WINDOW4	Color-box 8: BC- BR-BG-BB-blink-FR-FG-FB						

9 Application Hints

9.1 Software Hints

9.1.1 Programming Recommendations

1. If necessary write a new allocation just before the RAM reset.
2. If necessary write a new allocation at any time but take care of the window display.
3. When resetting the RAM and writing in it just after, write in the RAM respecting the same order as the reset: from the first to the last reset window, from the first window address (row 0, col 0) to the last, incrementing columns, then rows, then windows.
4. Define the window horizontal size prior to writing character and color codes in RAM. HSWI is used to compute the RAM address.

9.1.2 Examples of Programming

Hard reset at power-up (following a power-up)

1. Write Window 0 registers to set the OSD parameters: write
 - VCO[1:0], horizontal resolution and vertical height of characters,
 - the position of reference,
 - the allocations if they are incorrect
(by default: 320 characters for window 1, 128 characters for each of the others windows)
 - the windows position and size,
 - the color-boxes that will be used.
2. Write the character codes for each window to display.
3. Write the color-box data for each window to display.
4. Write the enable of windows: ENWi = 1 then ENOSD=1.

Change of position & size of 1 window (ex. window 3) without disable of window

1. Write new position and sizes.
2. Write new characters in the RAM.

Re-allocation, reset, and writing new characters in windows

1. Disable windows.
2. Write new allocations.
3. Reset the windows.
4. Write new positions and sizes in control registers.
5. Write new color-boxes.
6. Write new characters and color codes.
7. Enable windows.

9.2 Hardware Hints

- The serial resistors on the ROUT, GOUT, BOUT and FBLK outputs must be as close as possible to the device.
- Both decoupling capacitors (100 nF and 100 μ F) must be as close as possible to the analog (pin 13) and digital (pin5) power supplies (see [Figure 14](#)).
- PLL network must be close to the device but far from the ROUT, GOUT, BOUT and FBLK outputs. PLL network and ROUT, GOUT, BOUT and FBLK outputs should be separated by the AVDD 3.3 V power trace (see [Figure 15](#) and [Figure 16](#)).
- PLL ground (AGND) **should not** be connected either to DVSS or to other grounds of the videoboard, as the ground is already connected internally (see [Figure 15](#) and [Figure 16](#)).

10 Application Diagrams

Figure 14: STV9936 - Application Diagram

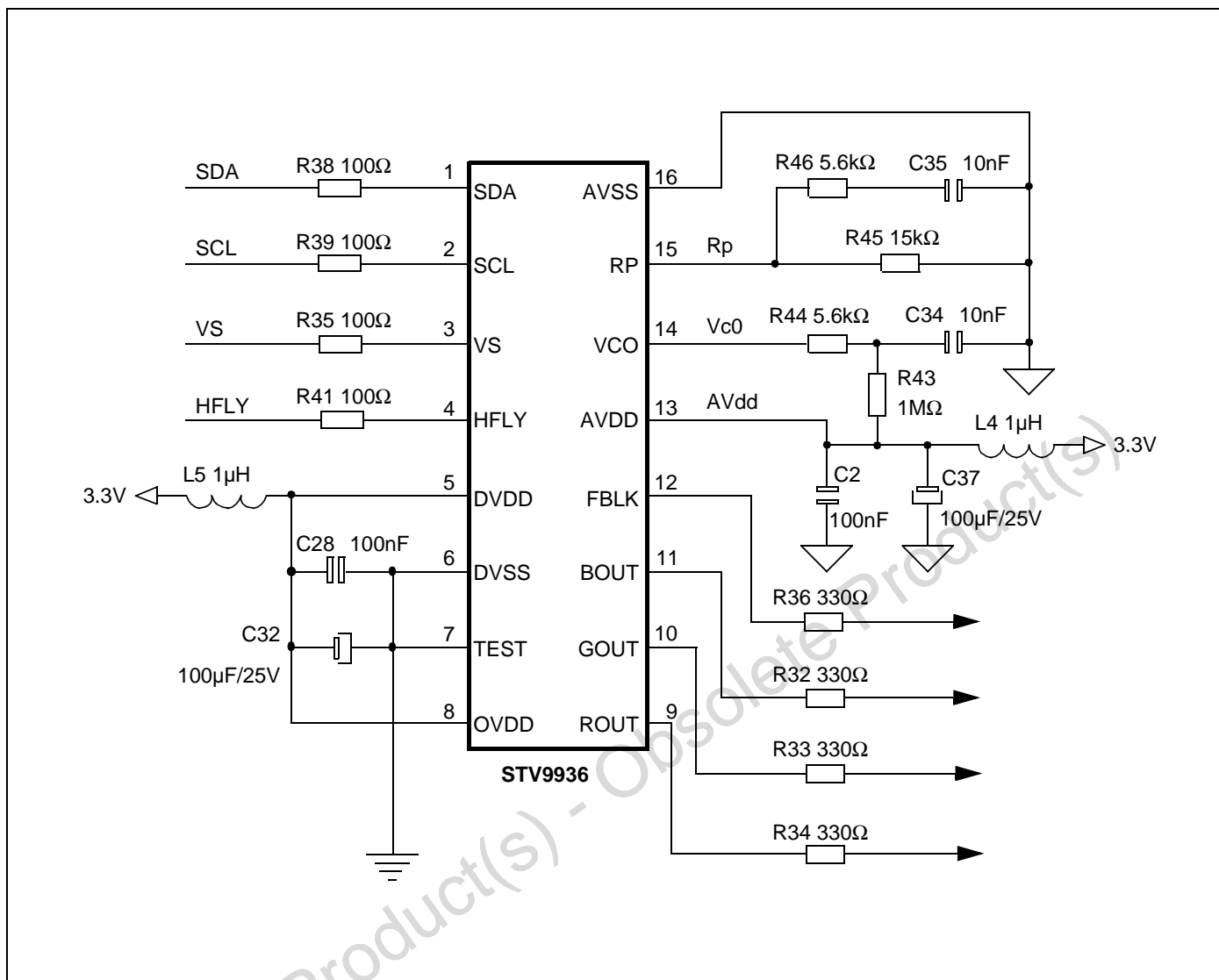

Figure 15: STV9936 Evaluation Board

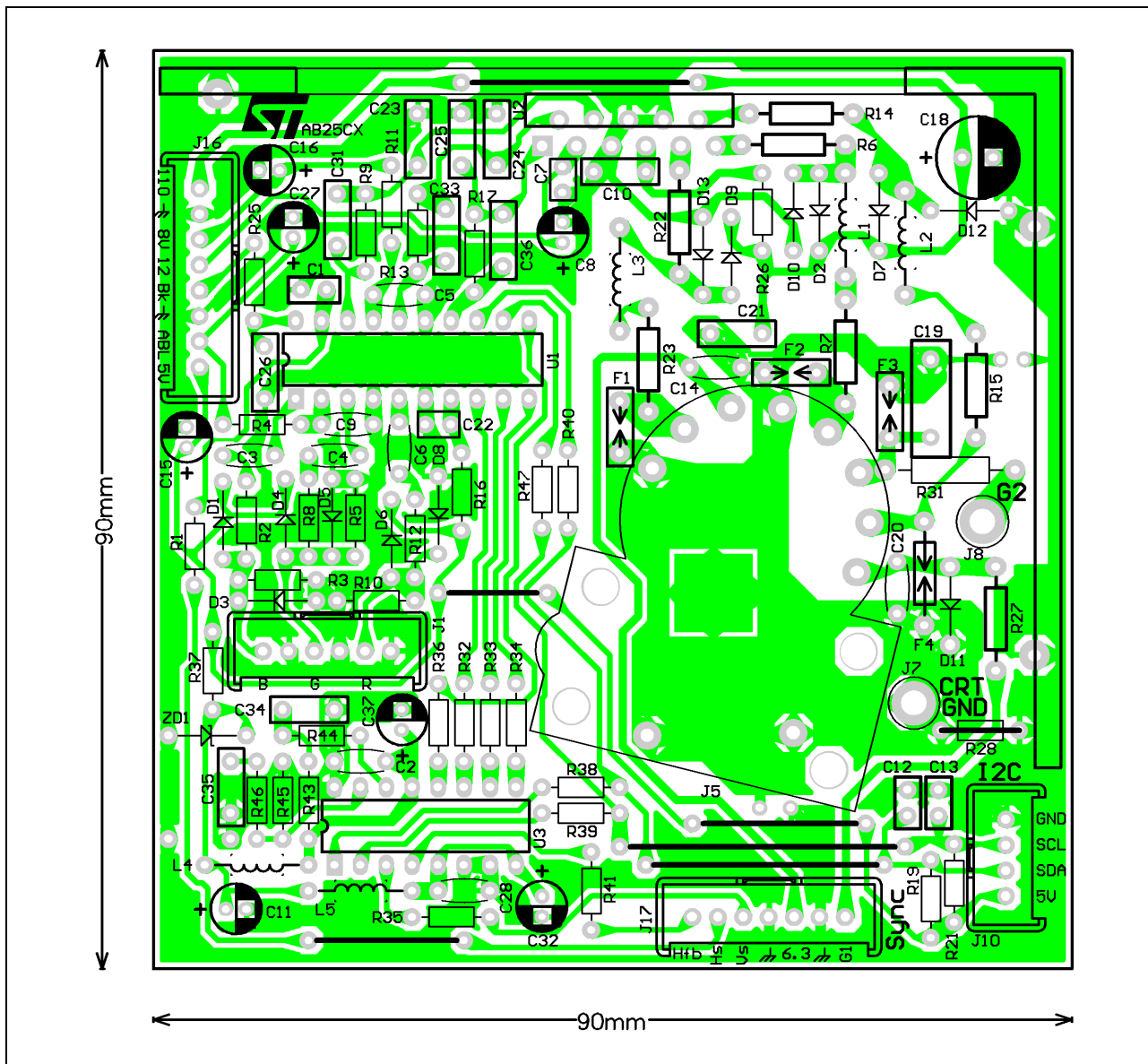
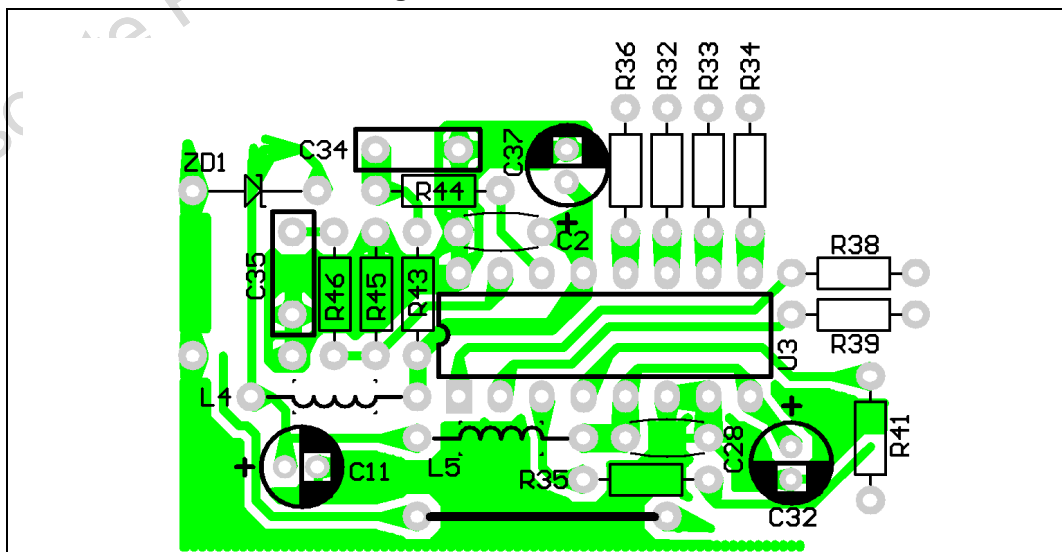

Figure 16: STV9936 - Zoom



11 Electrical and Timing Characteristics

11.1 Absolute Maximum Ratings

Symbol	Parameter	Value	Unit
AV_{DD} , DV_{DD} , OV_{DD}	DC Supply Voltage	-0.5, +4.0	V
V_{IN}	Input Voltage for SCL, SDA, VS and HFLY	-0.5, 5.5	V
	Input Voltage for test	VDD + 0.5	V
T_{OPER}	Ambient Operating Temperature	0, +70	°C
T_{STG}	Storage Temperature	-40, +125	°C

11.2 Operating Conditions

Symbol	Parameter	Min.	Typ.	Max.	Unit
VDD	DC Supply Voltage AV_{DD} , DV_{DD} , OV_{DD} .	3.0	3.3	3.6	V
T_{OPER}	Ambient Operating Temperature	0	25	70	°C

11.3 Electrical and Timing Characteristics

($V_{DD} = 3.3V$, $V_{SS} = 0V$, $T_A = 0$ to 70° , unless otherwise specified)

Symbol	Parameter	Min.	Typ.	Max.	Unit
Electrical Characteristics					
I_{DD}	Analog and Digital Supply Current $AI_{DD} + DI_{DD} + OI_{DD}$			30	mA
V_{IL}	Input Low Voltage (SCL, SDA, VS, HFLY and TEST pins)			0.8	V
V_{IH}	Input High Voltage (SCL, SDA, VS and HFLY pins) Test input is connected to ground	2.0		5.0	V
V_{OL}	ROUT, GOUT, BOUT and FBLK Output Low Voltage ($I_{OL} = 3$ mA)			0.4	V
	SDA Open Drain Output Low Voltage ($I_{OL} = 4$ mA)			0.4	V
V_{OH}	ROUT, GOUT, BOUT and FBLK Output High Voltage ($I_{OH} = 3$ mA)	2.4		-	V
	SDA Open Drain Output High Voltage, pulled up by external 3V to 5V power supply			5.0	V
Timing Characteristics					
Freq (Hline)	Horizontal Synchronization Input Range			150	kHz
t_r	ROUT, GOUT, BOUT and FBLK Output rise time ($C_{LOAD} = 15$ pF)		2		ns
t_f	ROUT, GOUT, BOUT and FBLK Output fall time ($C_{LOAD} = 15$ pF)		2		ns

11.4 I²C Bus Characteristics

Table 48: Characteristics of the SDA and SCL bus lines for F/S-mode I²C-bus devices

Symbol	Parameter	Standard mode		Fast mode		Unit
		Min.	Max.	Min.	Max.	
I²C Interface: SDA and SCL						
t_{SP}	Pulse width of spikes which must be suppressed by the input filter	n/a	n/a	0	50	ns
f_{SCL}	SCL clock frequency	0	100	0	400	kHz
$t_{HD;STA}$	Hold time (repeated) START Condition. After this period, the first clock pulse is generated	4.0		0.6		μ s
t_{LOW}	LOW period of the SCL clock	4.7		1.3		μ s
t_{HIGH}	HIGH period of the SCL clock	4.0		0.6		μ s
$t_{SU}; t_{STA}$	Set-up time for a repeated START condition	4.7		0.6		μ s
$t_{HD;DAT}$	Data hold time	0	3.45	0	0.9	μ s
$t_{SU;DAT}$	Data set-up time	250		100		ns
t_r	Rise time of both SCL and SDA signals		1000	$20 + 0.1C_b$	300	ns
t_f	Fall time of both SCL and SDA signals		300	$20 + 0.1C_b$	300	ns
$t_{SU}; t_{STO}$	Set-up time for STOP condition	4.0		0.6		μ s
t_{BUF}	Bus free time between a STOP and a START condition	4.7		1.3		μ s
C_b	Capacitive load for each bus line		400		400	pF

Figure 17: Definition of Timing for F/S-modes

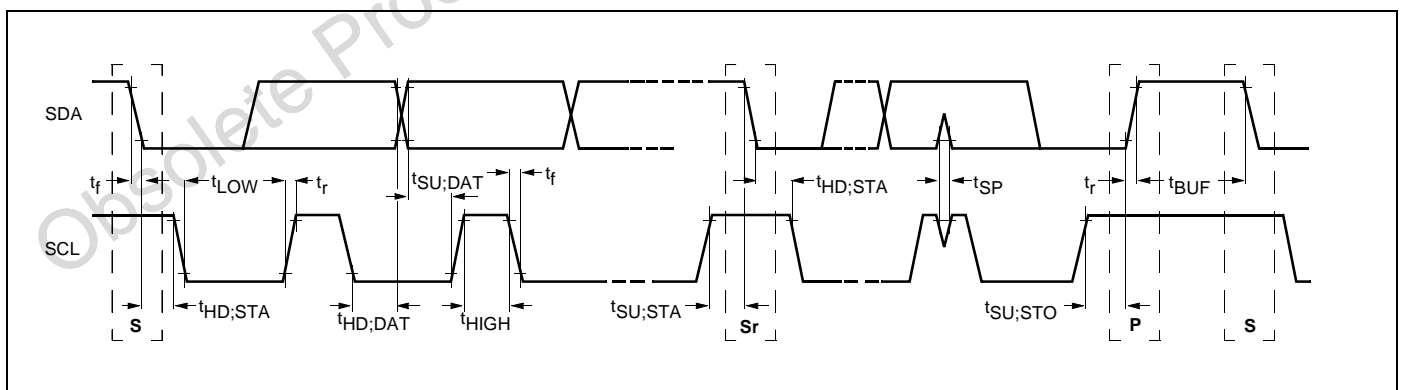

12 Package Mechanical Data

12.1 SO16 Narrow Plastic Micropackage

Figure 18: SO16 Narrow Plastic Micropackage

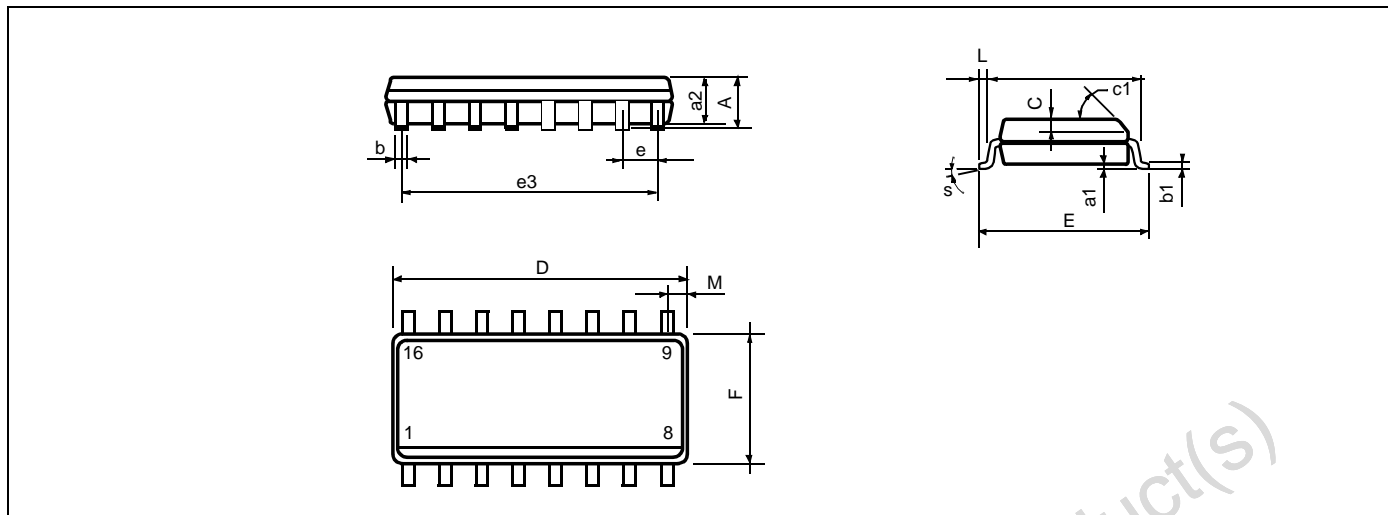

Table 49: SO16 Narrow Dimensions

Dim.	mm			inches		
	Min.	Typ.	Max.	Min.	Typ.	Max.
A			1.75			0.069
a1	0.1		0.25	0.004		0.009
a2			1.6			0.063
b	0.35		0.46	0.014		0.018
b1	0.19		0.25	0.007		0.010
C		0.5			0.020	
c1	45° (typ.)					
D[1]	9.8		10	0.386		0.394
E	5.8		6.2	0.228		0.244
e		1.27			0.050	
e3		8.89			0.350	
F[1]	3.8		4	0.150		0.157
G	4.6		5.3	1.181		0.209
L	0.4		1.27	0.016		0.050
M			0.62			0.024
S	8° (max.)					

12.2 Dual In-line Plastic Package

Figure 19: DIP16 Package

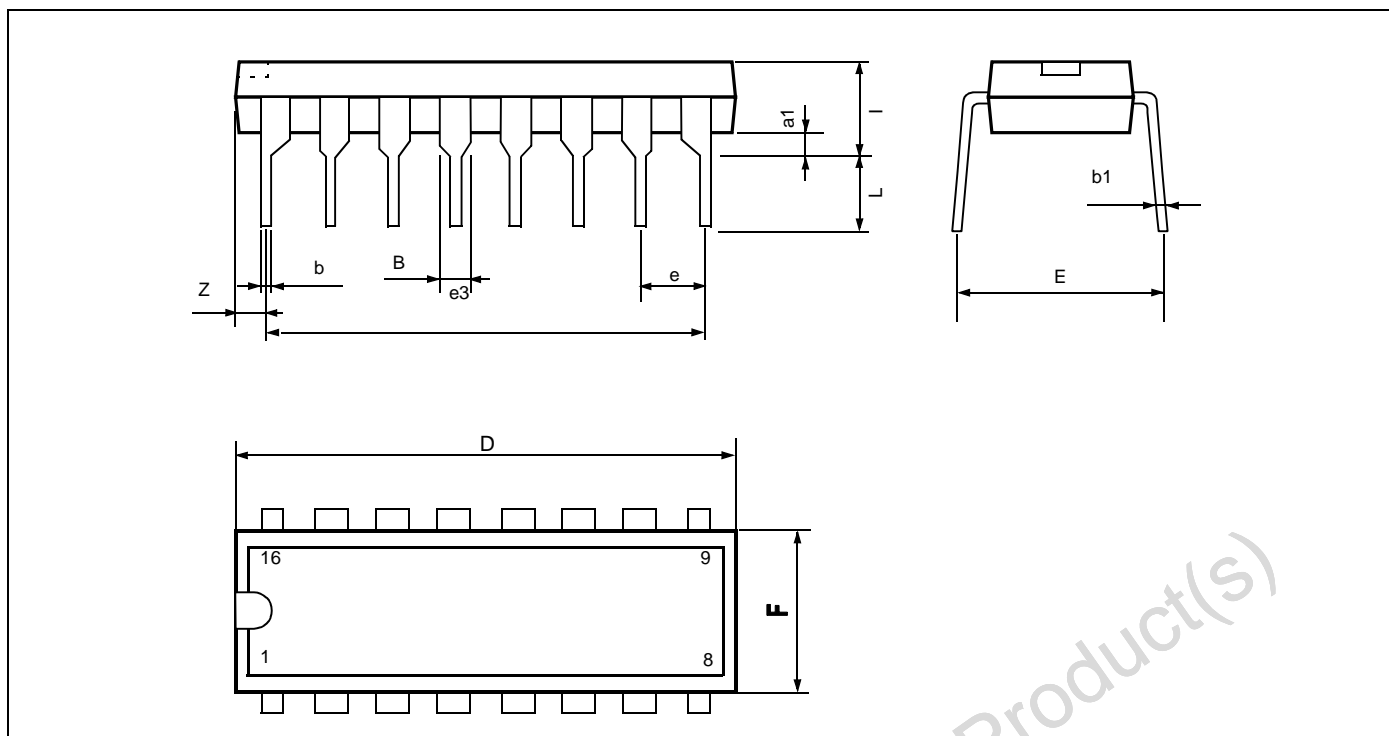
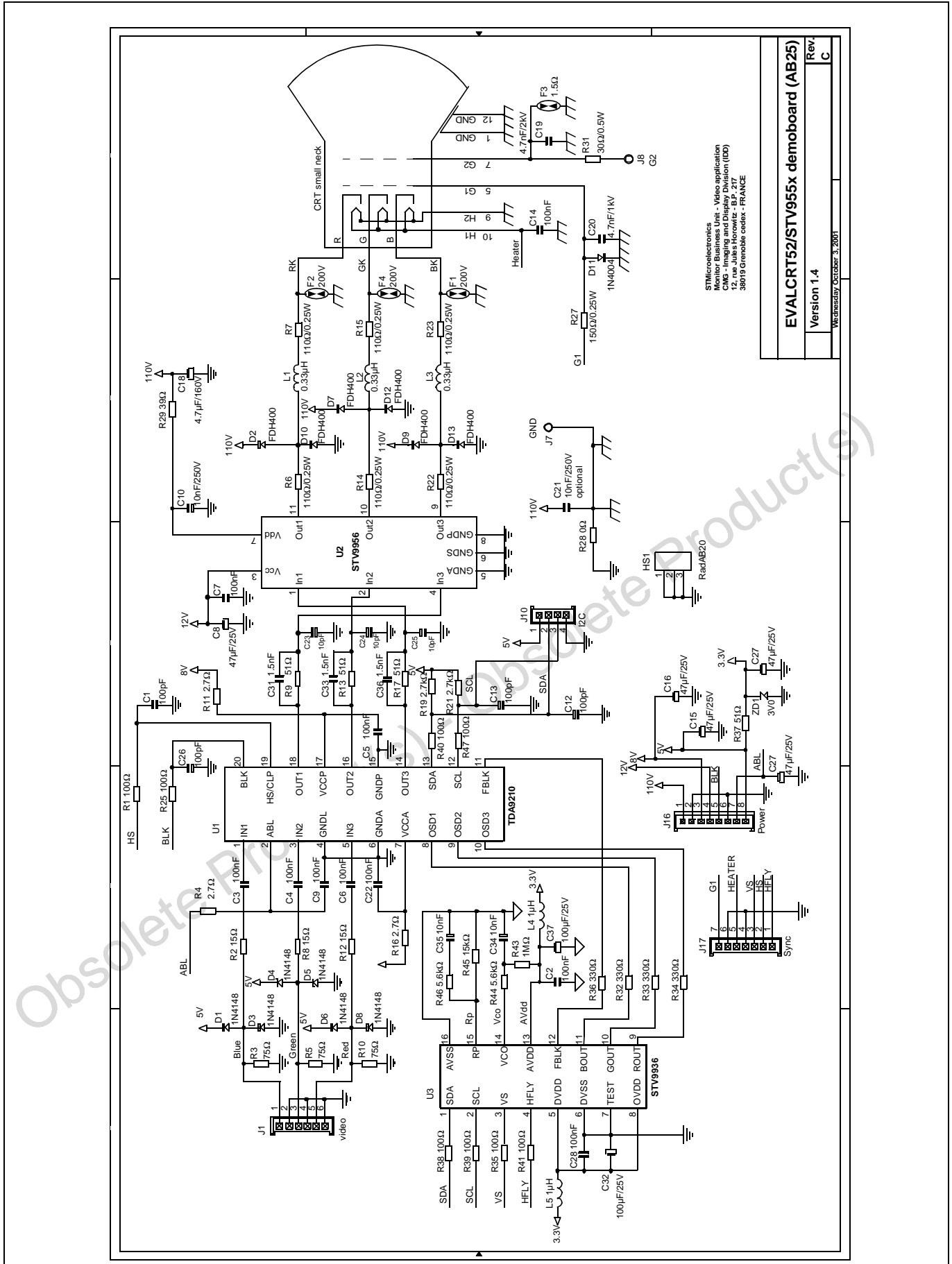

Table 50: DIP16 Dimensions

Dim.	mm			inches		
	Min.	Typ.	Max.	Min.	Typ.	Max.
a1	0.51			0.020		
B	0.77		1.65	0.030		0.065
b		0.5			0.020	
b1		0.25			0.010	
D			20			0.787
E		8.5			0.335	
e		2.54			0.100	
e3		17.78			0.700	
F			7.1			0.280
I			5.1			0.201
L		3.3			0.130	
Z			1.27			0.050

Figure 20: Evaluation Board of the STV955X - TDA9210 - STV9936



13 Revision History

Table 51: Summary of Modifications

Date	Version	Description
30 September 2002	3.1	Document upgraded to Datasheet. New presentation.
19 November 2002	3.2	Modification of Section 4.2: Horizontal Resolution .
17 January 2003	3.3	Various edits. Addition of Figure 12: /AC Character Fonts on page 27 . Table 46: Control Registers: Window 0, Row = 0 on page 36 changed to previous format.

Obsolete Product(s) - Obsolete Product(s)

Information furnished is believed to be accurate and reliable. However, STMicroelectronics assumes no responsibility for the consequences of use of such information nor for any infringement of patents or other rights of third parties which may result from its use. No license is granted by implication or otherwise under any patent or patent rights of STMicroelectronics. Specifications mentioned in this publication are subject to change without notice. This publication supersedes and replaces all information previously supplied. STMicroelectronics products are not authorized for use as critical components in life support devices or systems without express written approval of STMicroelectronics.

The ST logo is a registered trademark of STMicroelectronics

© 2003 STMicroelectronics - All Rights Reserved

STMicroelectronics GROUP OF COMPANIES

Australia - Brazil - Canada - China - Finland - France - Germany - Hong Kong - India - Israel - Italy - Japan
Malaysia - Malta - Morocco - Singapore - Spain - Sweden - Switzerland - United Kingdom - U.S.A.

www.st.com