

T4 MINI TRIM SWITCHES

4-WAY MINI TRIM, COMMERCIAL & MILITARY GRADES

The T4 Mini Trim is a single pole, 4 throw, center off, momentary contact (self return to center off). Numerous button styles are available on both the Commercial and Military grade switch versions. Mini Trims are typically press fit into control grips or panel mounted using versions with an 11/16" threaded case. Mini Trims are also available with multiple sealing levels to fit all applications.

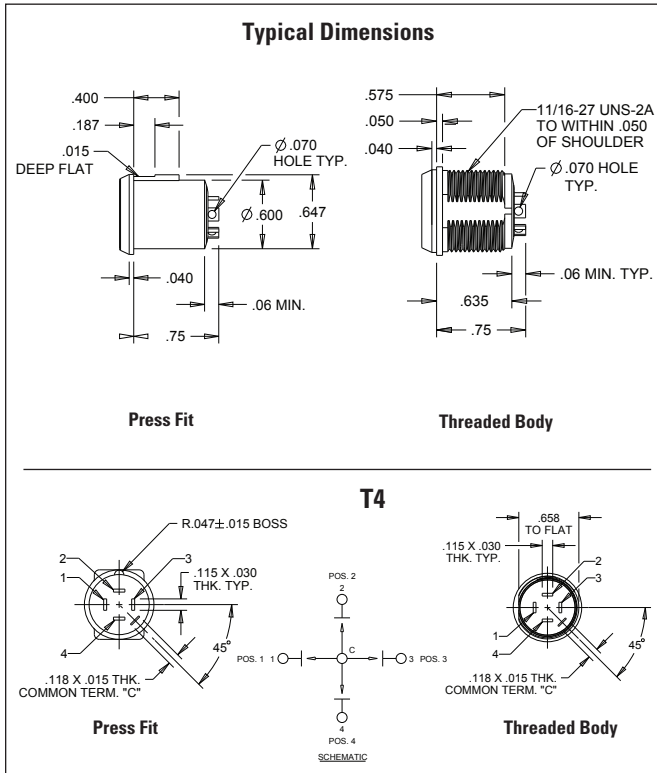

Standard Characteristics/Ratings:

ELECTRICAL RATINGS:	
Load	Rating
Resistive (low level)	10mA @ 30mV
Inductive	1A @ 28VDC
DWV	1050Vrms
Electrical Life:	100,000 cycles 1A Inductive @ 28VDC
Lever Travel:	15° max from center OFF
Seal:	IP64 or IP68S or MIL-PRF-8805 Design 3
Operating Temp Range:	-55°C to +85°C
Actuating Force:	16 oz +/- 6 oz
Lever Pivot & Stop Strength:	Switch is capable of withstanding a force of 25.0 lbs. applied to the actuating button. The button also withstands 15.0 lbs. minimum pull force.

MATERIALS:	
Case:	Aluminum alloy or thermoplastic
Button:	Thermoplastic
Terminals:	Silver over brass Brass with gold over silver for low level
Terminal Hardware:	None provided
Mounting Hardware:	Hex nut, tooth lockwasher, panel seal gasket where applicable

T4 MINI TRIM PART NUMBER CODE

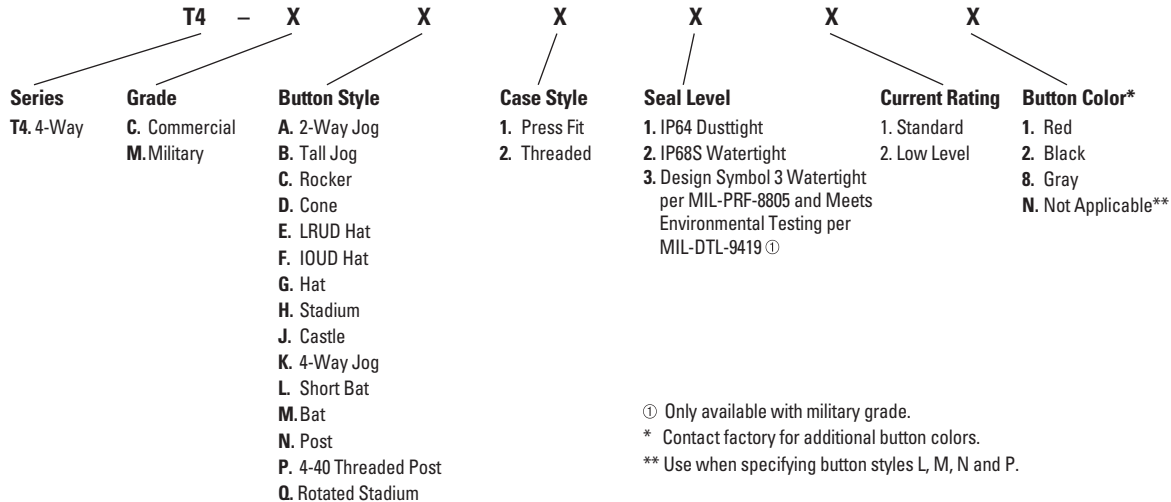



① Only available with military grade.
* Contact factory for additional button colors.
** Use when specifying button styles L, M, N and P.

T4 Mini Trim Button Styles are shown on the Button Styles page and in the appendix.

T1, T2, T4, T5 & T8 MINI TRIM BUTTON STYLES

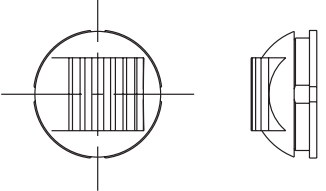
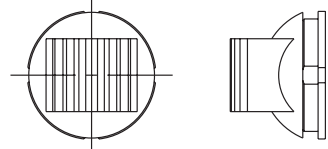
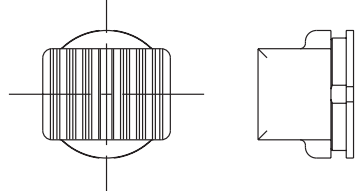
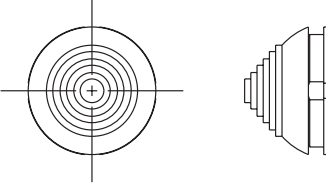
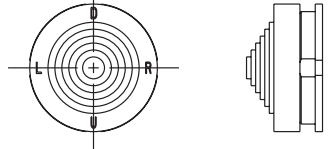
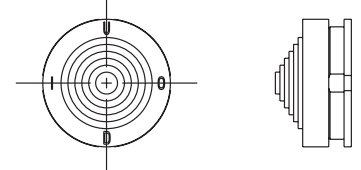
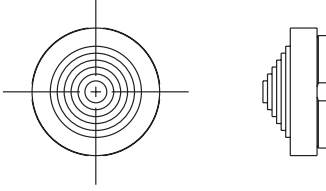
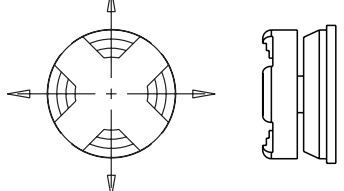
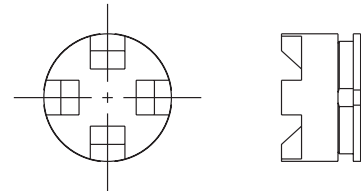
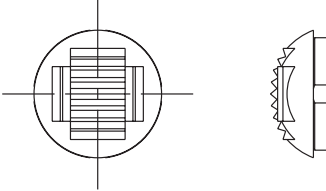
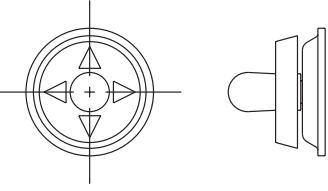
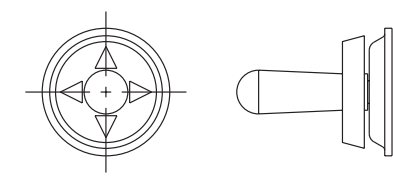
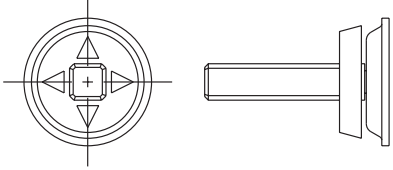
T1, T2, T4, T5 AND T8 MINI TRIM BUTTON STYLES

<p>A - 2-WAY JOG</p> 	<p>B - TALL JOG</p> 	<p>C - ROCKER</p> 
<p>D - CONE</p> 	<p>E - LRUD HAT</p> 	<p>F - IOUD HAT</p> 
<p>G - HAT</p> 	<p>H - STADIUM</p> 	<p>J - CASTLE</p> 
<p>K - 4-WAY JOG</p> 	<p>L - SHORT BAT</p> 	<p>M - LONG BAT</p> 
<p>N - POST</p> 	<p>P - 4-40 THREADED POST</p> 	<p>Q - ROTATED STADIUM</p> 