

Moderate Power High f_T NPN Silicon Transistor

MA4T856 Series

V3.00

Features

- High Output Power
 - 16 dBm P_{1dB} @ 1 GHz
 - 10 dBm P_{1dB} @ 2 GHz
- High Gain Bandwidth Product
- 8-9 GHz f_T
- High Power Gain
 - $|S_{21E}|^2 = 15$ dB @ 1 GHz
 - $|S_{21E}|^2 = 9$ dB @ 2 GHz
- Low Noise Figure
 - 1.5 dB @ 1.5 GHz

Description

The MA4T856 series of moderate power NPN transistors provides low noise at 5-10 volts operating voltage. These transistors are designed to optimize gain at moderate collector currents (20 - 60 mA).

They are useful as moderate power (+23-24 dBm) low noise amplifiers at 0.5-2 GHz or as low noise VCO transistors from 100 MHz to 5.0 GHz.

These inexpensive transistors are available in the SOT-23 (MA4T85633), the SOT-143 (MA4T85639), and the Micro-X (MA4T85635) packages. They are also available as chips (MA4T85600) for hybrid circuits. The plastic packages SOT-23 and SOT-143 are normally supplied on tape and reel.

Absolute Maximum Ratings¹

Parameter	Absolute Maximum
Collector-Base Voltage	20 V
Collector-Emitter Voltage	12 V
Emitter-Base Voltage	3.0 V
Collector Current	100 mA
Junction Temperature	
Chip or Ceramic Package	+200°C
Plastic Package	+150°C
Storage Temperature	
Chip or Ceramic Package	-65°C to +200°C
Plastic Package	-65°C to +200°C
Power Dissipation (die)	1200 mW ¹

1. See power derating curves.

Package Outline

SOT-23

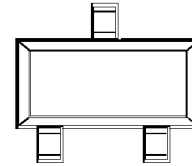

SOT-143

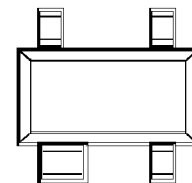

Chip

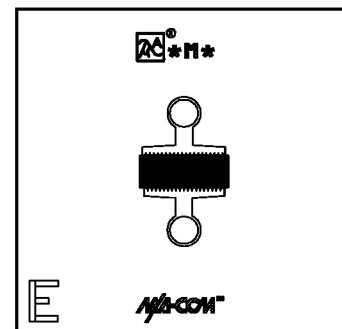

Micro-X

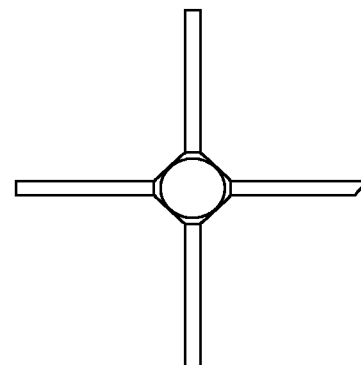

MA4T856 Series

Electrical Specifications @ +25°C

Symbol	Parameters	Test Conditions	Units	MA4T85600 Chips	MA4T85633 SOT-23	MA4T85635 Micro-X	MA4T85639 SOT-143
f_T	Gain Bandwidth Product	$V_{CE}=8V, I_C=30mA$	GHz	7.0 typ.	7.0 typ.	7.0 typ.	7.0 typ.
$ S_{21E} ^2$	Insertion Power Gain	$V_{CE}=8V, I_C=20mA, f=1GHz$	dB	13.5 min.	12 min.	13.0 min.	12 min.
NF	Noise Figure	$V_{CE}=8V, I_C=10mA, f=1GHz$	dB	1.6 max.	1.7 max.	1.6 max.	1.7 max.
GA	Associated Gain	$V_{CE}=8V, I_C=10mA, f=1GHz$	dB	16 typ.	15 typ.	16 typ.	15 typ.
P_{1dB}	Output Power at 1 dB Compression	$V_{CE}=8V, I_C=40mA, f=1GHz, f=2GHz$	dBm	16 typ. 10 typ.	13 typ. 10 typ.	16 typ. 10 typ.	13 typ. 10 typ.
$R_{TH}(J-A)$	Thermal Resistance	Junction/Ambient (Free Air)	°C/W	-	600 max.	550 max	600 max.
$R_{TH}(J-C)$	Thermal Resistance	Junction/Case	°C/W	60 max. ¹	200 typ.	200 typ.	200 typ.

1 See power derating curves.

Electrical Specifications @ +25°C

Symbol	Parameters	Test Conditions	Units	Min.	Typ.	Max.
I_{CBO}	Collector Cut-off Current	$V_{CB} = 8V, I_E = 0$	μA	-	-	1.0
I_{EBO}	Emitter Cut-off Current	$V_{EB} = 1V, I_C = 0$	μA	-	-	1
hFE	Forward Current Gain	$V_{CE} = 8V, I_C = 20mA$	-	20	100	250
C_{OB}	Collector-Base Junction Capacitance	$V_{CB} = 8V, f = 1MHz$	pF	-	0.62	0.75

MA4T85635

Typical Scattering Parameters in the Micro-X Package

$V_{CE} = 8V, I_C = 10mA$

Frequency (MHz)	S _{11E}		S _{21E}		S _{12E}		S _{22E}	
	Mag.	Angle	Mag.	Angle	Mag.	Angle	Mag.	Angle
200	0.581	-97.9	16.95	117.1	0.033	44.9	0.685	-46.4
400	0.516	-151.1	10.72	83.5	0.045	27.8	0.481	-65.0
600	0.496	177.1	7.59	60.3	0.054	17.9	0.396	-79.0
800	0.487	153.4	5.84	40.7	0.064	8.6	0.355	-91.6
1000	0.483	133.2	4.74	22.7	0.074	1.0	0.334	-105.0
1200	0.481	114.9	3.99	5.6	0.085	11.4	0.324	-118.0
1400	0.479	97.7	3.46	-11.0	0.097	22.2	0.317	-132.0
1600	0.478	81.2	3.06	-27.3	0.109	33.6	0.311	-147.0
1800	0.478	65.1	2.74	-43.4	0.121	45.4	0.311	-162.0
2000	0.476	49.4	2.49	-59.3	0.133	57.3	0.315	-177.0
2200	0.475	33.9	2.29	-75.0	0.145	69.5	0.314	168.4
2400	0.475	18.4	2.12	-90.6	0.158	82.0	0.311	152.6
2600	0.474	3.9	1.98	-106.1	0.170	94.7	0.317	136.0
2800	0.473	-12.2	1.86	-121.5	0.183	107.3	0.324	121.0
3000	0.472	-27.4	1.76	-136.7	0.197	120.1	0.323	107.0
4000	0.472	-103.3	1.39	148.1	0.267	174.4	0.336	28.5
5000	0.476	-176.5	1.17	74.8	0.340	107.1	0.367	-49.0
6000	0.484	104.4	1.03	3.1	0.415	38.2	0.375	-126.0

Specifications Subject to Change Without Notice.

M/A-COM Inc.

North America: Tel. (800) 366-2266 ♦ Asia/Pacific: Tel. +85 2 2111 8088 ♦ Europe: Tel. +44 (1344) 869-595
 Fax (800) 618-8883 Fax +85 2 2111 8087 Fax +44 (1344) 300-020

MA4T85635

Typical Scattering Parameters in the Micro-X Package

VCE = 8 Volts, IC = 20 mA

Frequency (MHz)	S11E		S21E		S12E		S22E	
	Mag.	Angle	Mag.	Angle	Mag.	Angle	Mag	Angle
200	0.469	-124.6	21.56	107.4	0.026	47.0	0.546	-53.6
400	0.456	-170.4	12.34	77.1	0.037	36.6	0.363	-69.8
600	0.453	163.3	8.50	56.0	0.050	28.2	0.298	-81.1
800	0.452	142.9	6.48	37.7	0.062	18.5	0.269	-92.9
1000	0.451	124.9	5.23	20.5	0.075	7.5	0.254	-105.6
1200	0.451	108.1	4.40	3.9	0.089	4.1	0.247	-119.2
1400	0.449	91.9	3.80	-12.3	0.102	16.2	0.244	-133.0
1600	0.448	76.2	3.35	-28.2	0.116	28.8	0.242	-147.8
1800	0.450	60.8	3.01	-44.0	0.130	41.5	0.243	-163.0
2000	0.448	45.5	2.73	-59.6	0.143	54.3	0.246	-177.5
2200	0.448	30.6	2.51	-75.2	0.157	67.3	0.246	167.9
2400	0.448	15.7	2.32	-90.6	0.170	80.4	0.246	152.4
2600	0.446	1.5	2.17	-105.9	0.184	93.6	0.251	136.5
2800	0.445	-14.0	2.04	-121.1	0.198	106.9	0.258	121.9
3000	0.442	-29.1	1.92	-136.3	0.212	120.1	0.260	107.2
4000	0.443	-104.0	1.52	148.8	0.281	172.7	0.275	29.1
5000	0.442	-177.9	1.29	75.3	0.351	104.5	0.307	-48.5
6000	0.456	105.2	1.13	3.2	0.419	35.6	0.318	-126.1

MA4T85635

Typical Scattering Parameters in the Micro-X Package

VCE = 8 Volts, IC = 40 mA

Frequency (MHz)	S11E		S21E		S12E		S22E	
	Mag.	Angle	Mag.	Angle	Mag.	Angle	Mag	Angle
200	0.426	-147.7	23.88	99.9	0.021	51.7	0.443	-56.7
400	0.438	175.6	12.94	72.7	0.034	43.8	0.296	-68.7
600	0.441	153.3	8.80	52.9	0.048	34.7	0.250	-79.0
800	0.442	134.9	6.67	35.3	0.062	23.9	0.230	-90.5
1000	0.442	118.0	5.38	18.5	0.076	11.9	0.222	-103.3
1200	0.442	101.9	4.51	2.2	0.090	0.5	0.219	-117.1
1400	0.441	86.1	3.90	-13.8	0.105	13.4	0.218	-131.1
1600	0.441	70.6	3.43	-29.6	0.119	26.4	0.218	-146.0
1800	0.443	55.3	3.08	-45.3	0.133	39.7	0.221	-161.3
2000	0.443	40.2	2.79	-60.8	0.147	52.9	0.225	-175.9
2200	0.443	25.3	2.56	-76.3	0.161	66.2	0.226	169.6
2400	0.443	10.6	2.37	-91.6	0.174	79.6	0.227	154.1
2600	0.442	-4.7	2.21	-106.8	0.188	93.1	0.233	138.3
2800	0.441	-19.2	2.07	-122.0	0.202	106.5	0.242	123.8
3000	0.440	-34.3	1.95	-137.2	0.216	120.0	0.244	109.4
4000	0.446	-109.5	1.54	148.1	0.283	172.3	0.264	32.3
5000	0.447	174.0	1.30	74.7	0.351	104.0	0.297	-43.8
6000	0.466	100.3	1.13	2.9	0.414	35.3	0.307	-119.7

MA4T85639

Typical Scattering Parameters in the SOT-143 Package

VCE = 3 Volts, IC = 20 mA

Frequency (MHz)	S11E		S21E		S12E		S22E	
	Mag.	Angle	Mag.	Angle	Mag.	Angle	Mag	Angle
200	0.471	-118.4	19.14	115.5	0.034	56.7	0.492	-54.8
400	0.457	-152.6	10.70	97.7	0.048	57.2	0.297	-66.2
600	0.458	-168.7	7.33	88.2	0.064	60.7	0.219	-71.4
800	0.461	-178.9	5.57	81.4	0.079	61.1	0.183	-75.3
1000	0.466	173.0	4.48	75.7	0.095	62.3	0.168	-80.1
1200	0.471	166.0	3.76	70.3	0.110	60.7	0.158	-85.0
1400	0.476	160.2	3.24	65.5	0.128	60.1	0.156	-89.3
1600	0.480	155.0	2.86	61.1	0.144	59.0	0.154	-94.0
1800	0.485	150.1	2.56	56.7	0.158	56.9	0.157	-98.3
2000	0.491	144.8	2.32	52.3	0.172	56.3	0.157	-101.4
2200	0.488	141.5	2.12	48.8	0.190	55.7	0.167	-104.8
2400	0.496	137.1	1.97	44.7	0.207	53.2	0.172	-108.7
2600	0.499	132.9	1.83	40.8	0.220	50.6	0.180	-111.6
2800	0.510	129.4	1.71	37.3	0.233	48.8	0.183	-115.9
3000	0.513	125.8	1.62	34.0	0.249	46.8	0.184	-118.5

MA4T85639

Typical Scattering Parameters in the SOT-143 Package

VCE = 3 Volts, IC = 40 mA

Frequency (MHz)	S11E		S21E		S12E		S22E	
	Mag.	Angle	Mag.	Angle	Mag.	Angle	Mag	Angle
200	0.447	-140.1	20.11	108.5	0.028	59.4	0.376	-60.8
400	0.460	-165.5	10.77	93.6	0.043	65.0	0.221	-69.4
600	0.467	-177.5	7.30	85.3	0.062	67.1	0.166	-74.5
800	0.473	174.3	5.53	79.2	0.079	66.6	0.141	-78.2
1000	0.478	167.7	4.44	73.9	0.096	66.4	0.130	-84.2
1200	0.484	161.8	3.72	68.8	0.112	64.5	0.127	-89.1
1400	0.490	156.6	3.21	64.1	0.128	63.7	0.127	-93.9
1600	0.492	151.9	2.83	59.8	0.148	61.9	0.128	-98.7
1800	0.499	147.4	2.53	55.6	0.163	59.3	0.134	-103.4
2000	0.504	142.4	2.30	51.3	0.177	57.6	0.138	-106.8
2200	0.501	139.3	2.10	47.9	0.195	57.0	0.151	-109.4
2400	0.509	135.3	1.94	43.8	0.210	54.7	0.151	-113.5
2600	0.511	131.0	1.81	39.9	0.225	51.5	0.160	-115.6
2800	0.521	127.3	1.70	36.4	0.238	49.9	0.164	-119.3
3000	0.527	124.2	1.60	33.1	0.255	47.5	0.170	-123.7

Specifications Subject to Change Without Notice.

M/A-COM Inc.

North America: Tel. (800) 366-2266
Fax (800) 618-8883Asia/Pacific: Tel. +85 2 2111 8088
Fax +85 2 2111 8087Europe: Tel. +44 (1344) 869-595
Fax +44 (1344) 300-020

MA4T85639

Typical Scattering Parameters in the SOT-143 Package

VCE = 8 Volts, IC = 20 mA

Frequency (MHz)	S11E		S21E		S12E		S22E	
	Mag.	Angle	Mag.	Angle	Mag.	Angle	Mag	Angle
200	0.500	-98.3	20.35	119.5	0.030	59.3	0.580	-38.8
400	0.423	-137.3	11.71	100.4	0.042	57.3	0.394	-43.0
600	0.406	-157.4	8.09	90.4	0.055	61.6	0.322	-42.7
800	0.404	-170.3	6.17	83.2	0.068	62.8	0.290	-43.0
1000	0.406	-179.7	4.97	77.3	0.081	62.4	0.272	-45.2
1200	0.409	172.1	4.17	71.7	0.096	61.1	0.264	-47.8
1400	0.416	165.6	3.59	66.8	0.109	61.5	0.257	-50.9
1600	0.418	159.7	3.16	62.2	0.123	60.5	0.254	-54.1
1800	0.425	154.5	2.83	57.9	0.134	58.3	0.255	-57.9
2000	0.431	149.0	2.57	53.2	0.144	58.4	0.254	-61.7
2200	0.431	145.3	2.33	49.7	0.163	57.8	0.264	-65.6
2400	0.439	140.9	2.16	45.6	0.175	56.8	0.265	-69.2
2600	0.446	136.5	2.01	41.7	0.188	54.2	0.268	-72.9
2800	0.457	132.4	1.88	38.0	0.199	52.3	0.273	-76.4
3000	0.463	129.3	1.77	34.5	0.212	50.7	0.271	-80.0

MA4T85639

Typical Scattering Parameters in the SOT-143 Package

VCE = 8 Volts, IC = 40 mA

Frequency (MHz)	S11E		S21E		S12E		S22E	
	Mag.	Angle	Mag.	Angle	Mag.	Angle	Mag	Angle
200	0.455	-116.2	21.21	112.3	0.026	58.5	0.492	-38.2
400	0.414	-150.6	11.59	95.8	0.038	61.8	0.350	-37.6
600	0.410	-166.9	7.90	87.0	0.052	64.9	0.303	-36.0
800	0.412	-177.6	5.98	80.4	0.66	64.4	0.282	-36.7
1000	0.417	174.6	4.82	74.9	0.079	67.4	0.268	-39.3
1200	0.422	167.4	4.04	69.6	0.092	65.2	0.265	-42.4
1400	0.429	161.8	3.48	64.8	0.109	64.3	0.263	-45.7
1600	0.432	156.4	3.06	60.4	0.123	63.1	0.260	-49.7
1800	0.439	151.7	2.74	56.1	0.136	60.6	0.260	-54.2
2000	0.447	146.4	2.48	51.5	0.146	60.1	0.260	-58.0
2200	0.444	143.0	2.25	48.0	0.163	59.1	0.272	-62.0
2400	0.455	138.8	2.09	43.8	0.177	57.4	0.272	-66.1
2600	0.460	134.5	1.94	39.8	0.188	54.8	0.276	-69.7
2800	0.472	131.0	1.82	36.1	0.199	52.4	0.282	-73.7
3000	0.479	127.7	1.70	32.7	0.211	51.4	0.279	-77.3

Typical Performance Curves

MA4T856 SERIES POWER DISSIPATION

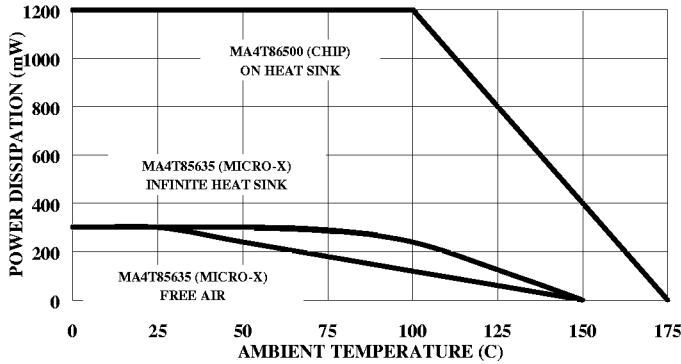

MA4T856 SERIES POWER DISSIPATION

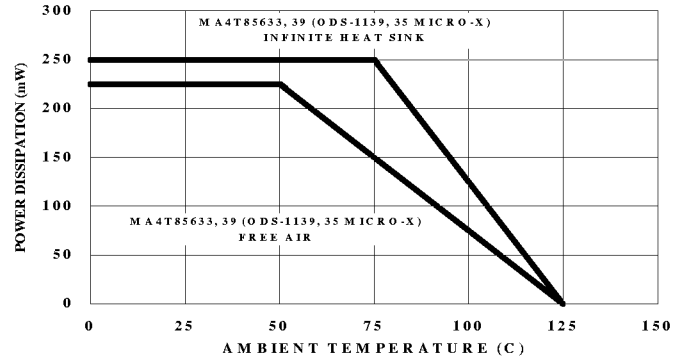

MA4T85635
NOMINAL GAIN vs FREQUENCY
at $V_{CE} = 8$ VOLTS and $I_C = 20$ mA

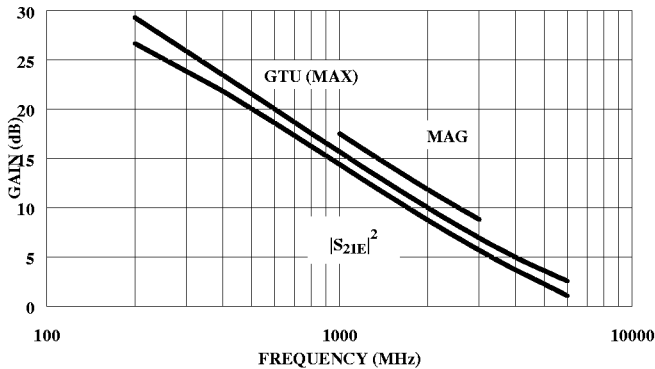

MA4T85635
NOMINAL GAIN vs FREQUENCY
at $V_{CE} = 8$ VOLTS and $I_C = 40$ mA

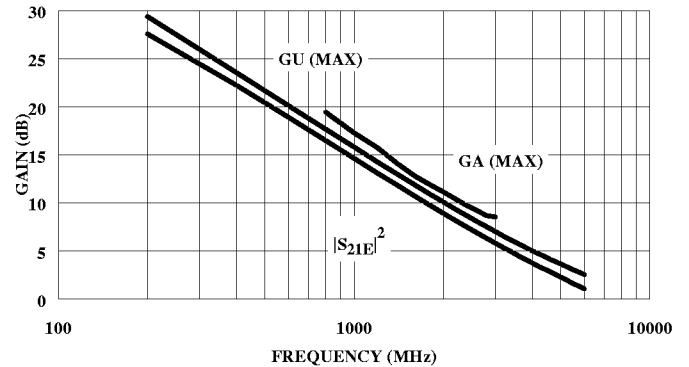

MA4T85635
NOMINAL GAIN vs COLLECTOR CURRENT
at $F = 1$ GHz and $V_{CE} = 8$ VOLTS

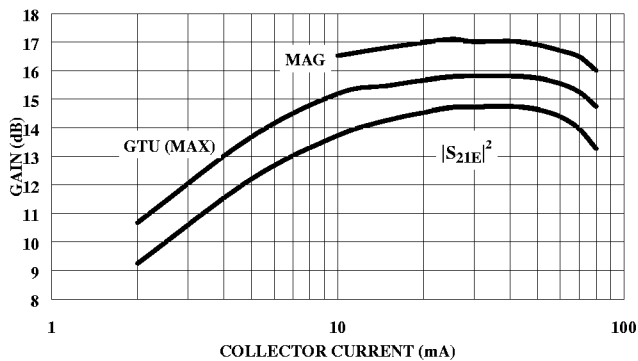

MA4T85600
NOMINAL GAIN vs COLLECTOR CURRENT
at $F = 1$ GHz and $V_{CE} = 8$ VOLTS

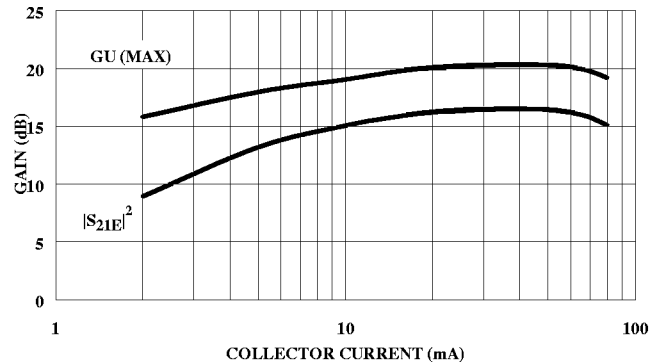

Specifications Subject to Change Without Notice.

M/A-COM Inc.

North America: Tel. (800) 366-2266
Fax (800) 618-8883

Asia/Pacific: Tel. +85 2 2111 8088
Fax +85 2 2111 8087

Europe: Tel. +44 (1344) 869-595
Fax +44 (1344) 300-020

Typical Performance Curves (Cont'd)

MA4T85600
CAPACITANCE vs COLLECTOR-BASE VOLTAGE

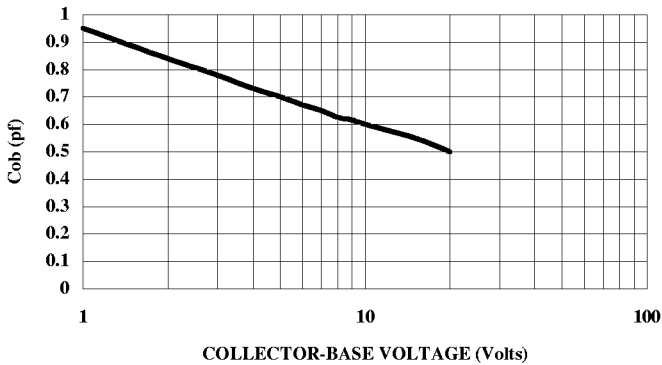

NOMINAL DC CURRENT GAIN (hFE) vs COLLECTOR CURRENT at Vce = 8 VOLTS

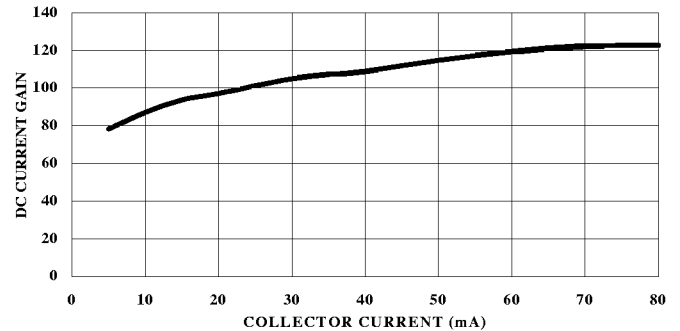

NOMINAL NOISE FIGURE and ASSOCIATED GAIN at F = 1 GHz COLLECTOR CURRENT at VCE = 8 VOLTS (MA4T85635)

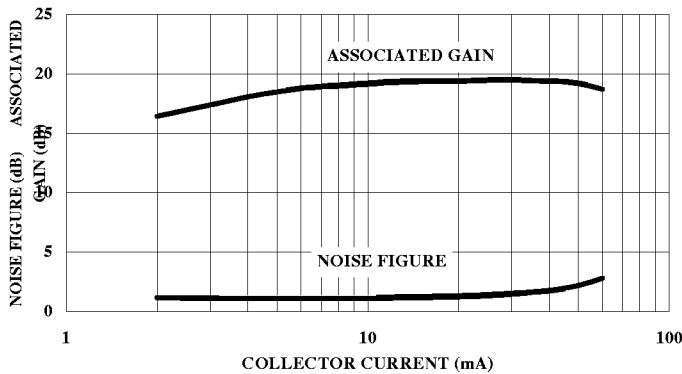

NOMINAL POWER OUTPUT at the 1dB COMPRESSION POINT vs COLLECTOR CURRENT at F=1 and 2 GHz and VCE = 8 VOLTS (MA4T85635)

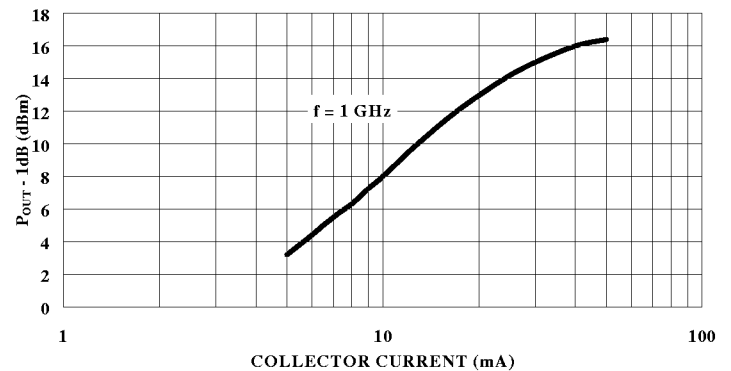

Case Styles
Chip (MA4T85600)
Case Style 1169

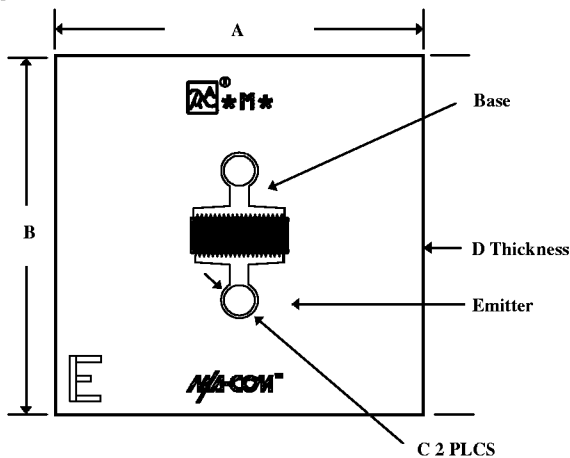

MA4T85600

DIM.	INCHES (Nominal)	MM (Nominal)
A	0.013	0.35
B	0.013	0.35
C	0.0012	0.03
D	0.0045	0.11

Specifications Subject to Change Without Notice

M/A-COM Inc.

North America: Tel. (800) 366-2266
Fax (800) 618-8883

Asia/Pacific: Tel. +85 2 2111 8088
Fax +85 2 2111 8087

Europe: Tel. +44 (1344) 869-595
Fax +44 (1344) 300-020

Case Styles (Cont'd)

SOT-23 (MA4T85633)

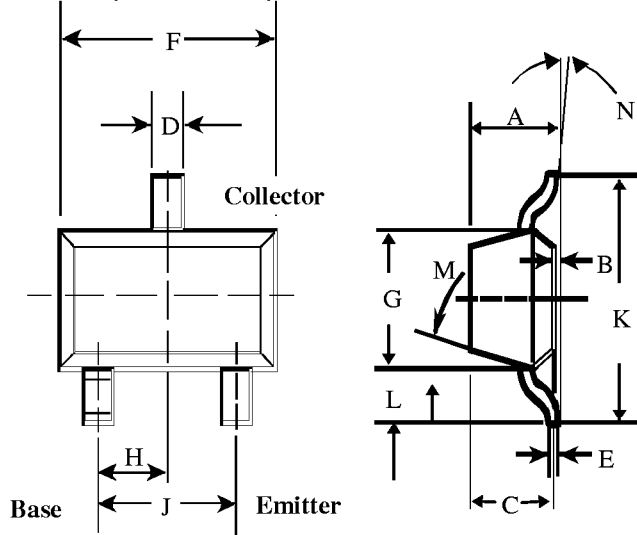

MA4T85633

DIM.	INCHES		MILLIMETERS	
	MIN.	MAX.	MIN.	MAX.
A	—	0.044	—	1.12
B	—	0.004	—	0.10
C	—	0.040	—	1.00
D	0.013	0.020	0.35	0.50
E	0.003	0.006	0.08	0.15
F	0.110	0.119	2.80	3.00
G	0.047	0.056	1.20	1.40
H	0.037 typical		0.95 typical	
J	0.075 typical		1.90 typical	
K	—	0.103	—	2.60
L	—	0.024	—	0.60

DIM.	GRADIENT
M	10° max. ¹
N	2° ... 30°

NOTE:
1. Applicable on all sides

Micro-X (MA4T85635)
Case Style 1139

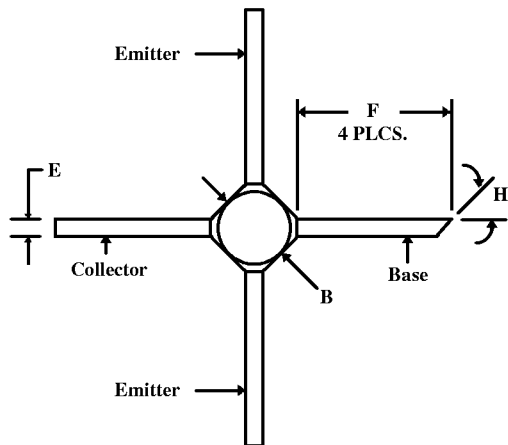

MA4T85635

DIM.	INCHES		MILLIMETERS	
	MIN.	MAX.	MIN.	MAX.
A	0.092	0.108	2.34	2.74
B	0.079	0.087	2.01	2.21
C	—	0.070	—	1.78
D	0.019	0.025	0.48	0.64
E	0.018	0.022	0.046	0.56
F	0.150	—	3.81	—
G	0.003	0.006	0.08	0.15
H	45°		45°	

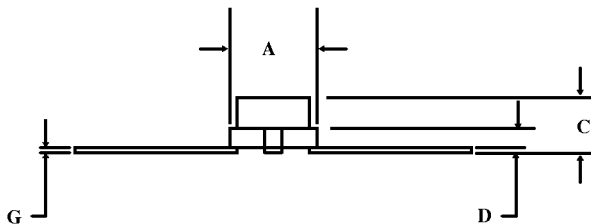

Specifications Subject to Change Without Notice.

M/A-COM Inc.

North America: Tel. (800) 366-2266 ♦ Asia/Pacific: Tel. +85 2 2111 8088 ♦ Europe: Tel. +44 (1344) 869-595
 Fax (800) 618-8883 Fax +85 2 2111 8087 Fax +44 (1344) 300-020

Case Styles (Cont'd)

SOT-143 (MA4T85639)

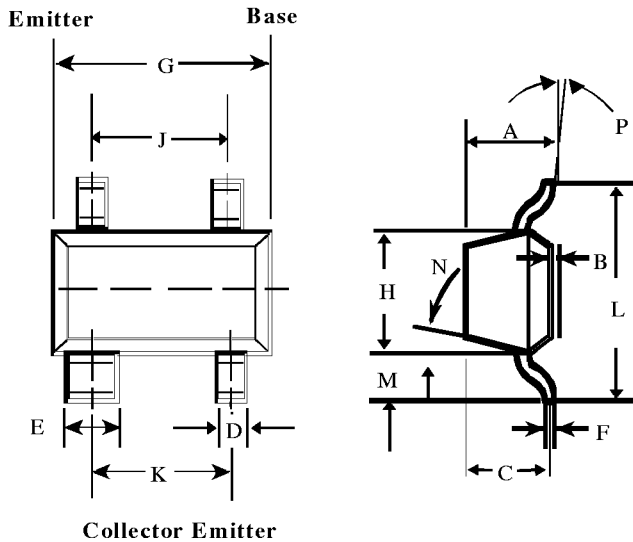

MA4T85639

DIM.	INCHES		MILLIMETERS	
	MIN.	MAX.	MIN.	MAX.
A	—	0.044	—	1.10
B	—	0.044	—	1.10
C	—	0.040	—	1.00
D	0.030	0.035	0.75	0.90
E	0.013	0.020	0.35	0.50
F	0.003	0.006	0.08	0.15
G	0.110	0.119	2.80	3.00
H	0.047	0.056	1.20	1.40
J	0.075 typical		1.90 typical	
K	0.075 typical		1.90 typical	
L	—	0.103	—	2.6
M	—	0.024	—	0.6

DIM.	GRADIENT
N	10° max. ¹
P	2° . . . 30°

NOTE:

1. Applicable on all sides

Specifications Subject to Change Without Notice.

M/A-COM Inc.

North America: Tel. (800) 366-2266 ♦ Asia/Pacific: Tel. +85 2 2111 8088 ♦ Europe: Tel. +44 (1344) 869-595
Fax (800) 618-8883 Fax +85 2 2111 8087 Fax +44 (1344) 300-020

Specifications Subject to Change Without Notice

North America: Tel. (800) 366-2266
Fax (800) 618-8883

♦ Asia/Pacific: Tel. +85 2 2111 8088
Fax +85 2 2111 8087

♦ Europe: Tel. +44 (1344) 869-595
Fax +44 (1344) 300-020

M/A-COM Inc.

Specifications Subject to Change Without Notice.

M/A-COM Inc.

North America: Tel. (800) 366-2266 ♦ Asia/Pacific: Tel. +85 2 2111 8088 ♦ Europe: Tel. +44 (1344) 869-595
Fax (800) 618-8883 Fax +85 2 2111 8087 Fax +44 (1344) 300-020