

GENERAL PURPOSE SOLID STATE RELAY 4PIN DIP TYPE FORM A SSR

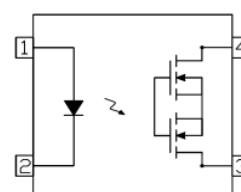

Schematic



Pin Configuration

- 1, LED Anode
- 2, LED Cathode
- 3,4, MOSFET

Features

- Normally open signal pole signal throw relay
- Low operating current
- 60 to 600V output withstand voltage
- Low on resistance
- Wide operating temperature range of -40°C to 85°C
- High isolation voltage between input and output (Viso = 5000 Vrms)
- UL 1577 + cUL approved (No. E214129)
- UL 508 + cUL approved (No. E348721)
- VDE approved (No. 40028391)
- SEMKO approved
- NEMKO approved
- DEMKO approved
- FIMKO approved
- CQC approved

Description

The EL406A, EL425A, EL440A and EL460A are solid state relays containing an AlGaAs infrared LEDs on the light emitting side (input side) optically coupled to a high voltage output detector circuit. The detector consists of a photovoltaic diode array and MOSFETs on the output side. The single channel configuration is equivalent to 1 form A EMR. They are packaged in 4 pin DIP and available in surface mount SMD option.

Applications

- Exchange equipment
- Measurement equipment
- FA/OA equipment
- Industrial controls
- Security

Absolute Maximum Ratings ($T_A=25^{\circ}\text{C}$, unless otherwise specified)

	Parameter	Symbol	Rating				Unit
			EL406A	EL425A	EL440A	EL460A	
Input	Forward Current	I_F		50			mA
	Reverse Voltage	V_R		5			V
	Peak Forward Current* ¹	I_{FP}		1			A
	Power Dissipation	P_{in}		75			mW
Output	Break Down Voltage	V_L	60	250	400	600	V
	Continuous Load Current	I_L	550	180	120	50	mA
	Pulse Load Current* ²	I_{LPeak}	1.2	0.5	0.3	0.15	A
	Power Dissipation	P_{out}		500			mW
	Total Power Dissipation	P_T		550			mW
	Isolation Voltage* ³	V_{iso}		5000			Vrms
	Storage Temperature	T_{STG}		-40 to 125			$^{\circ}\text{C}$
	Operating Temperature	T_{OPR}		-40 to 85			$^{\circ}\text{C}$
	Soldering Temperature* ⁴	T_{SOL}		260			$^{\circ}\text{C}$

Notes:

*1. $f=100\text{Hz}$, Duty Cycle = 0.1%

*2. A connection: 100ms (1 shot), $V_L = \text{DC}$

*3. AC for 1 minute, R.H. = 40 ~ 60% R.H. In this test, pins 1, 2 are shorted together, and pins 3, 4 are shorted together.

*4. For 10 seconds

Electro-Optical Characteristics ($T_A=25^{\circ}\text{C}$)

	Parameter	Symbol	Condition	Min.	Typ.	Max.	Unit	
Input	Forward Voltage	V_F	$I_F = 10\text{mA}$	-	1.18	1.5	V	
	Reverse Current	I_R	$V_R = 5\text{V}$	-	-	1	μA	
Output	Off State leakage Current	I_{leak}	$I_F = 0\text{mA}, V_L = \text{Max.}$	-	-	1	μA	
	On Resistance	EL406A	$R_{d(\text{ON})}$	$I_F = 10\text{mA}, I_L = \text{Max.}$ $t = 1\text{s}$	-	0.7	2.5	Ω
		EL425A			-	6.5	15	
		EL440A			-	20	30	
EL460A		-			40	70		
Output Capacitance	EL406A	C_{out}	$V_L = 0\text{V}, f = 1\text{MHz}$	-	85	-	pF	
	EL425A			-	60	-		
	EL440A			-	45	-		
	EL460A			-	30	-		
Transfer Characteristics	LED turn on Current	EL406A	$I_{F(\text{on})}$	$I_L = \text{Max.}$	-	2.9	5	mA
		EL425A			-	2.84	5	
		EL440A			-	2.92	5	
		EL460A			-	2.38	5	
	LED turn off current	EL406A	$I_{F(\text{off})}$	$I_L = \text{Max.}$	0.4	2.74	-	mA
		EL425A			0.4	2.72	-	
		EL440A			0.4	2.78	-	
		EL460A			0.4	2.26	-	
	Turn On Time	EL406A	T_{on}	$I_F = 10\text{mA}, I_L = \text{Max.}$ $R_L = 200\Omega$	-	1.4	3	ms
		EL425A			-	1.2	3	
		EL440A			-	0.4	3	
		EL460A			-	1.4	3	
Turn Off Time	EL406A	T_{off}	$I_F = 10\text{mA}, I_L = \text{Max.}$ $R_L = 200\Omega$	-	0.05	0.5	ms	
	EL425A			-	0.05	0.5		
	EL440A			-	0.05	0.5		
	EL460A			-	0.05	0.5		
	Isolation Resistance	R_{I-O}	$V_{I-O} = 500\text{V DC}$	5×10^{10}	-	-	Ω	
	Isolation Capacitance	C_{I-O}	$V = 0\text{V}, f = 1\text{MHz}$	-	1.5	-	pF	

Turn on/Turn off Time

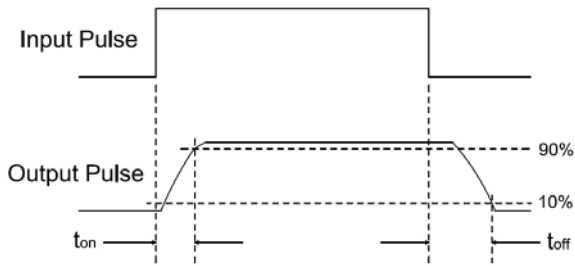

Typical Electro-Optical Characteristics Curves

Figure 1-1. Load current vs Ambient temperature

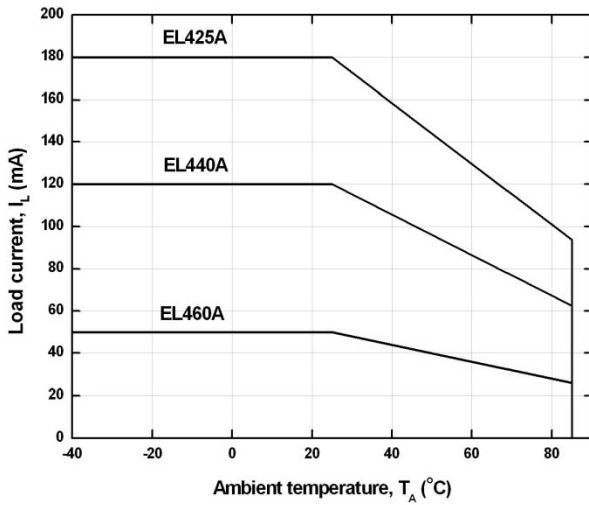

Figure 1-2. Load current vs Ambient temperature

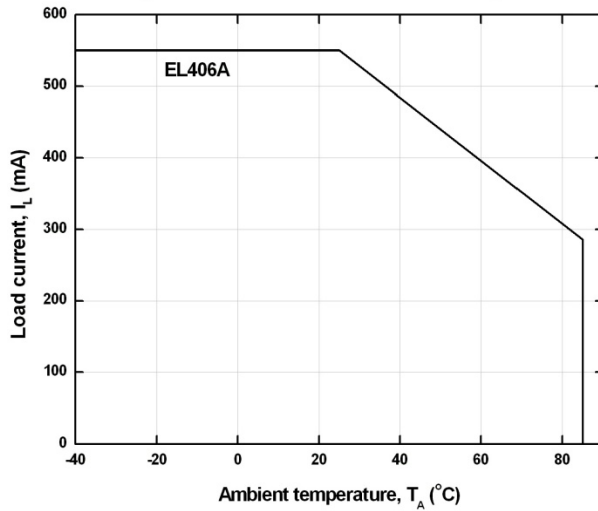

Figure 2-1. On Resistance vs Ambient Temperature

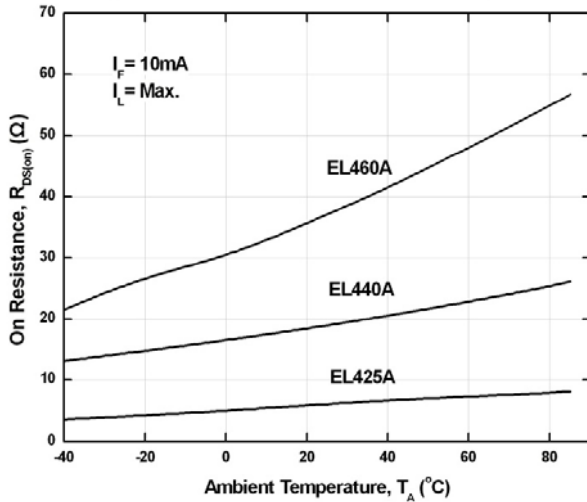

Figure 2-2. On Resistance vs Ambient Temperature

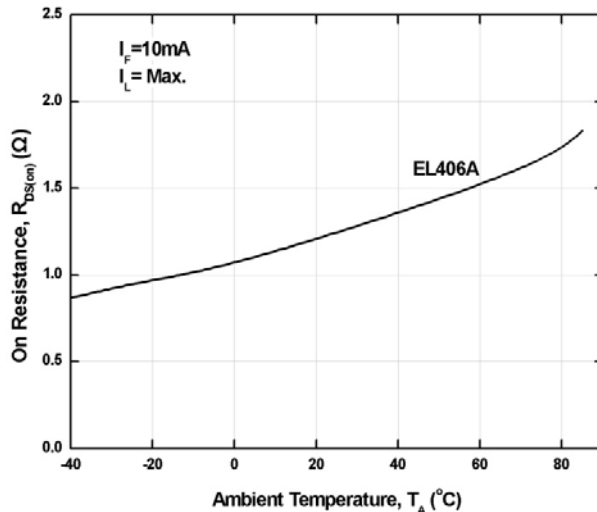

Figure 3. Switching Time vs Ambient Temperature

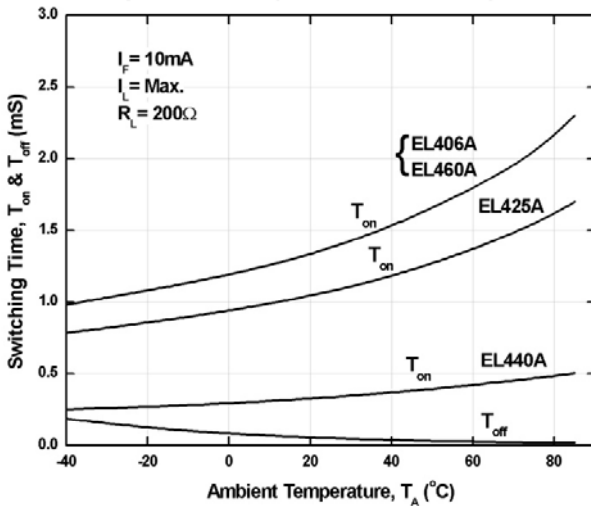

Figure 4-1. Turn On Time vs LED Forward Current

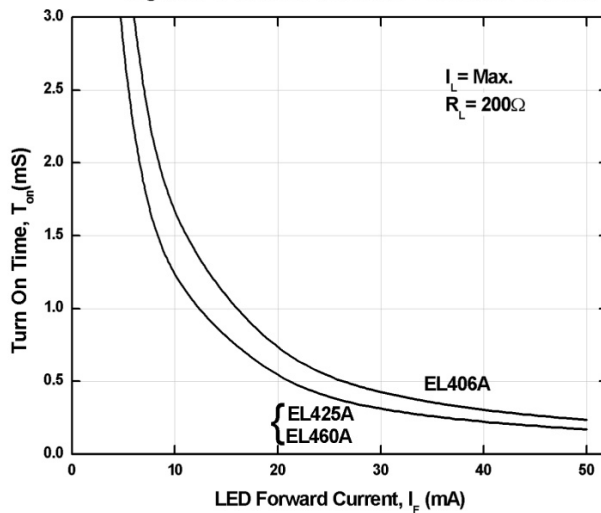

Figure 4-2. Turn On Time vs LED Forward Current

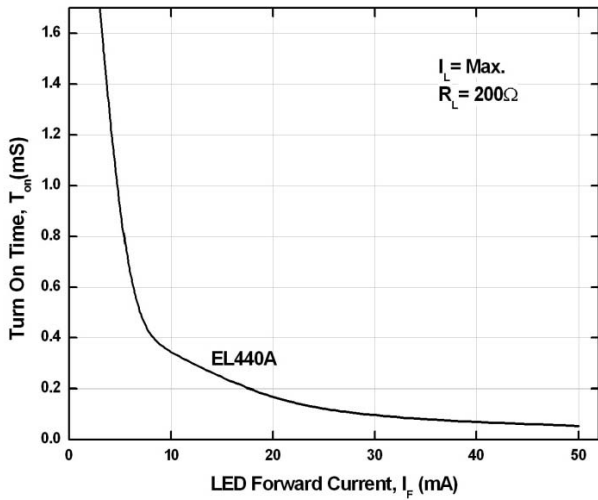

Figure 5. Turn Off Time vs LED Forward Current

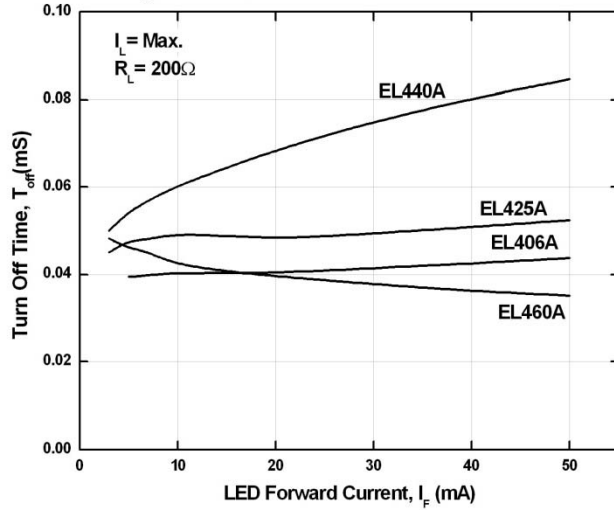

Figure 6. Normalized LED Operate on Current vs Ambient Temperature

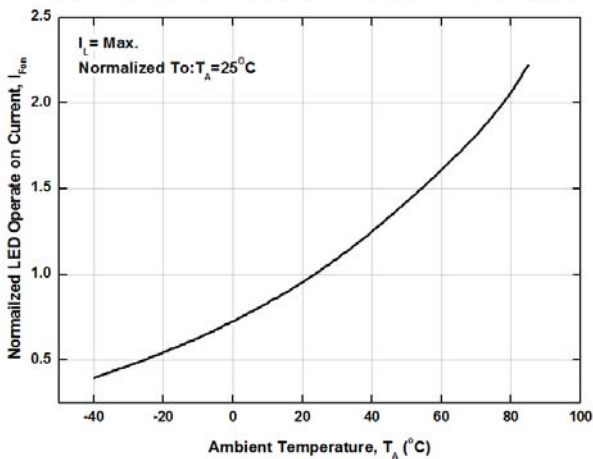

Figure 7. Normalized LED Turn off Current vs Ambient Temperature

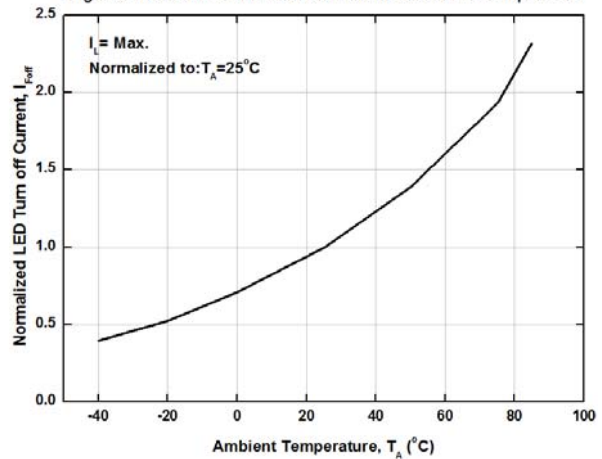

Figure 8. LED Dropout Voltage vs Ambient Temperature

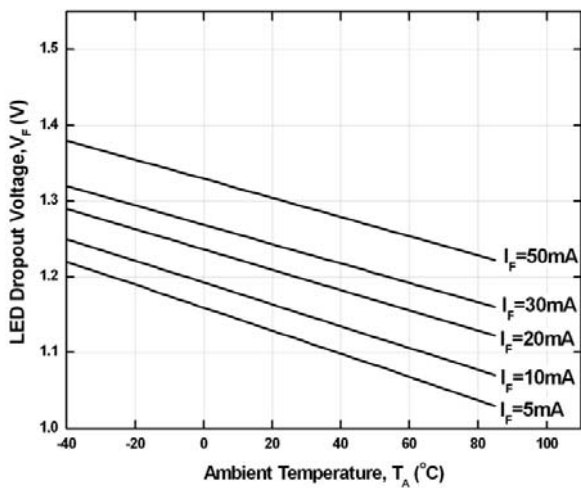

Figure 9-1. Load Voltage vs Load Current

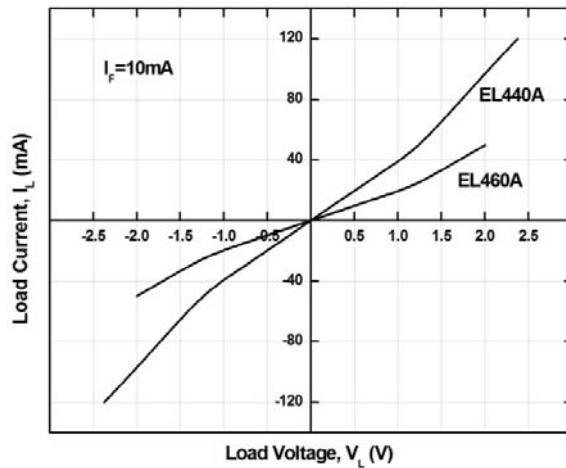

Figure 9-2. Load Voltage vs Load Current

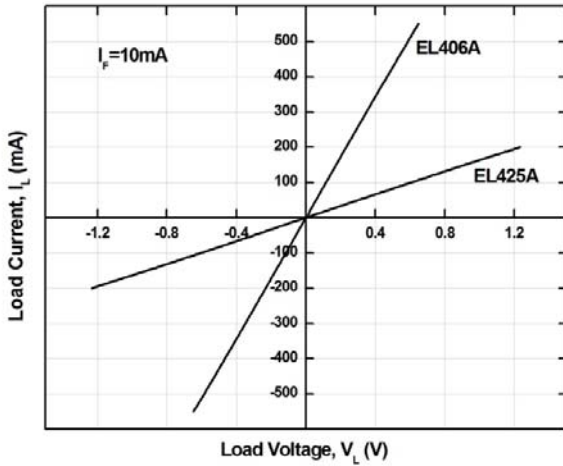

Figure 10. Off State Leakage Current vs Load Voltage

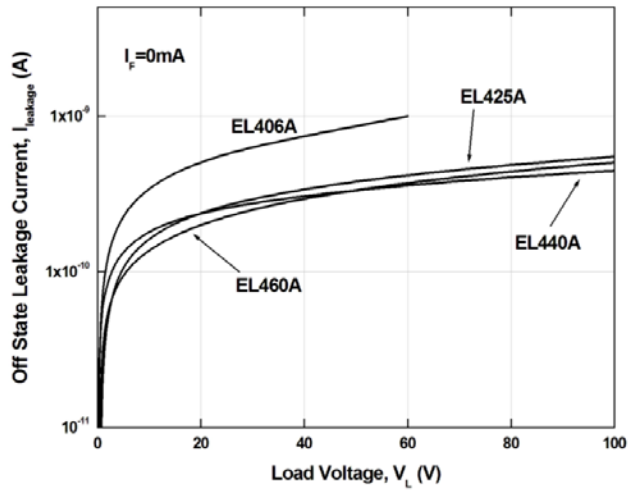
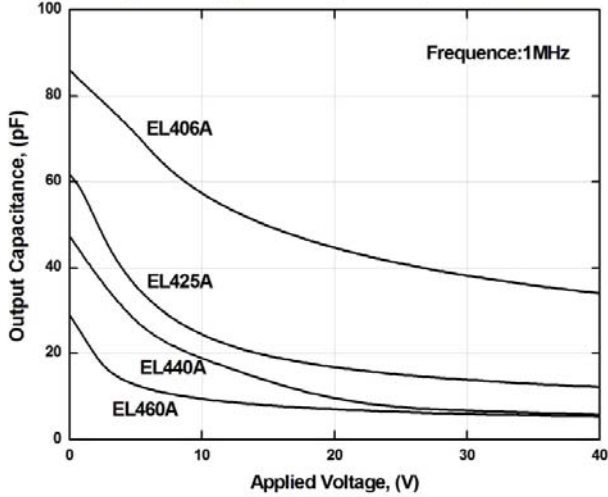

Figure 11. Applied Voltage VS Output Capacitance



Order Information

Part Number

EL4XXA(Y)(Z)-V

Note:

XX = Part No. (06, 25, 40 or 60)

Y = Lead form option (S1, or none)

Z = Tape and reel option (TA, TB, TU, TD or none).

V = VDE safety approved option

Option	Description	Packing quantity
None	Standard DIP-4	100 units per tube
S1 (TA)	Surface mount lead form (low profile) + TA tape & reel option	1000 units per reel
S1 (TB)	Surface mount lead form (low profile) + TB tape & reel option	1000 units per reel
S1 (TU)	Surface mount lead form (low profile) + TU tape & reel option	1500 units per reel
S1 (TD)	Surface mount lead form (low profile) + TD tape & reel option	1500 units per reel

Package Dimension
(Dimensions in mm)

Standard DIP Type

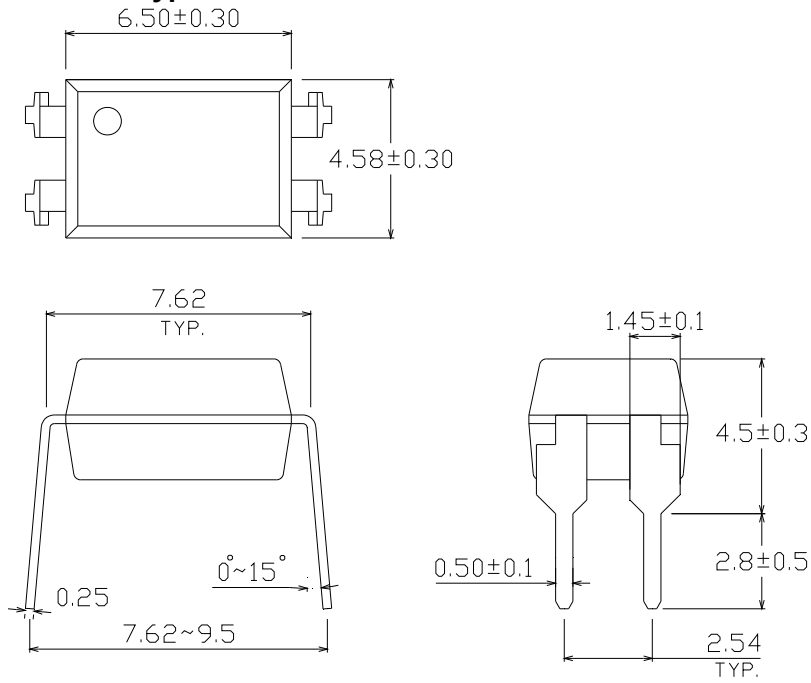

Option S1 Type

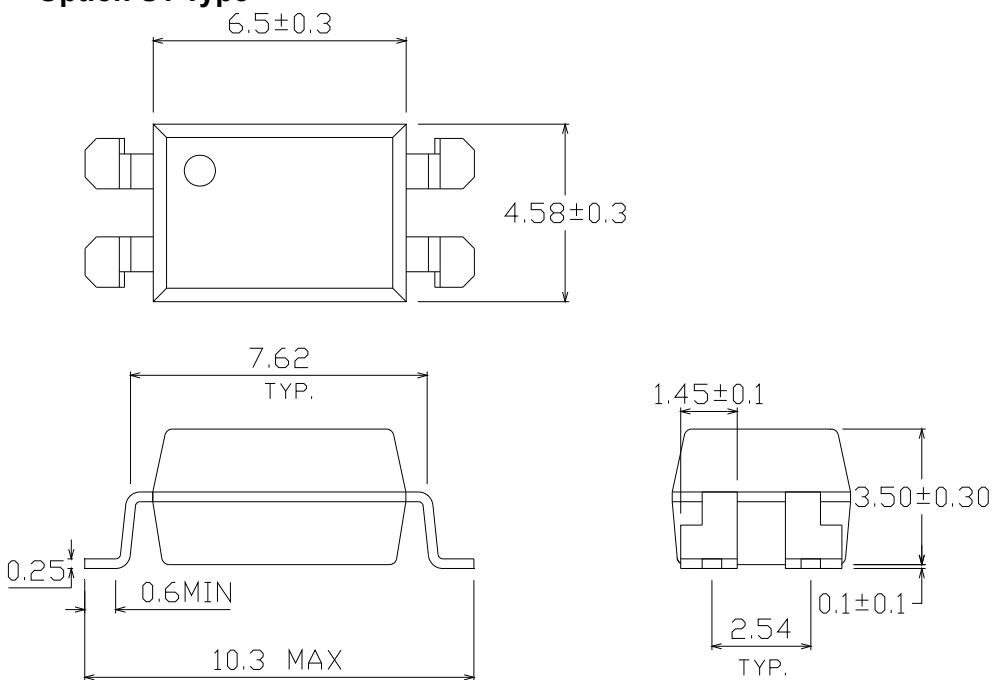

Recommended Pad Layout for Surface Mount Leadform

4Pin SMD

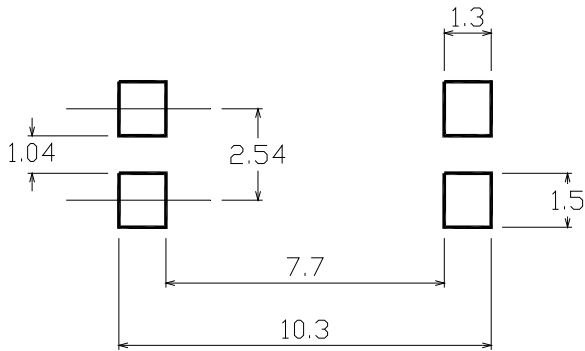

Device Marking

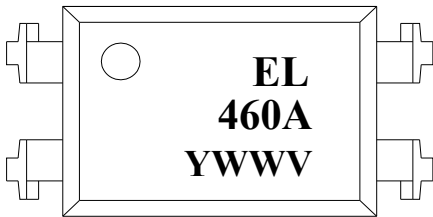

Notes

- EL denotes Everlight
- 460A denotes Part Number
- Y denotes 1 digit Year code
- WW denotes 2 digit Week code
- V denotes VDE option

Tape & Reel Packing Specifications

Option TA

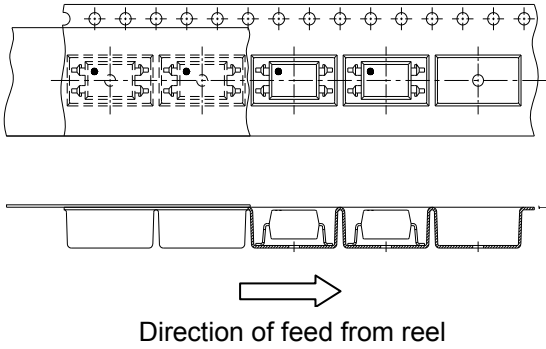

Option TB

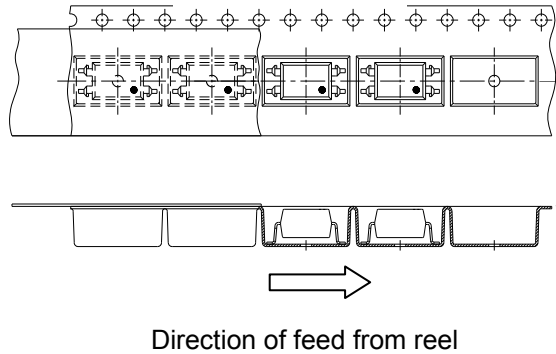

Tape Dimensions

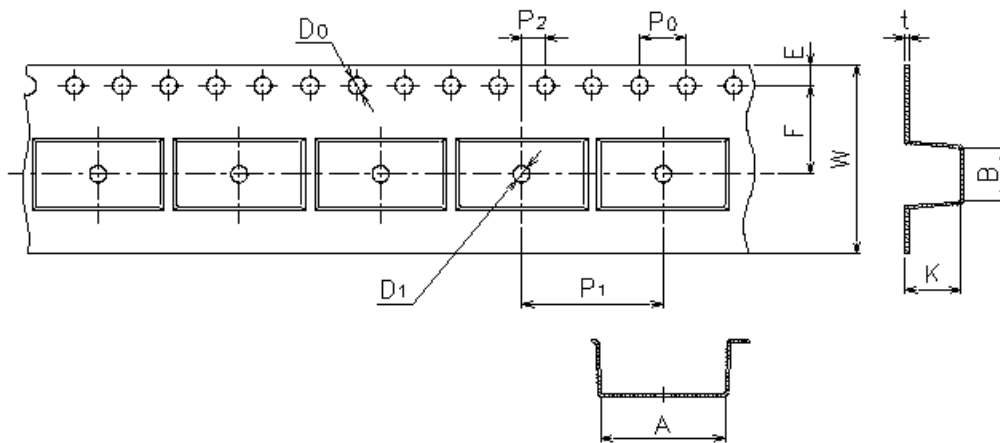

Dimension No.	A	B	Do	D1	E	F
Dimension(mm) S1	10.5±0.1	4.65±0.1	1.5±0.1	1.50±0.1	1.75±0.1	7.5±0.1
Dimension No.	Po	P1	P2	t	W	K
Dimension(mm) S1	4.0±0.1	12.0±0.1	2.0±0.1	0.4±0.1	16.0±0.3	4.75±0.1

Option TD

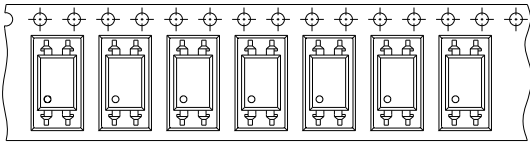

Direction of feed from reel

Option TU

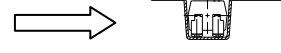
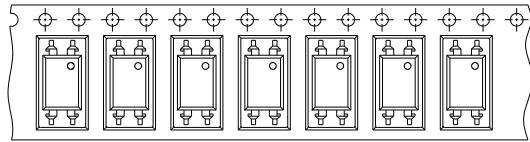

Direction of feed from reel

Tape Dimensions

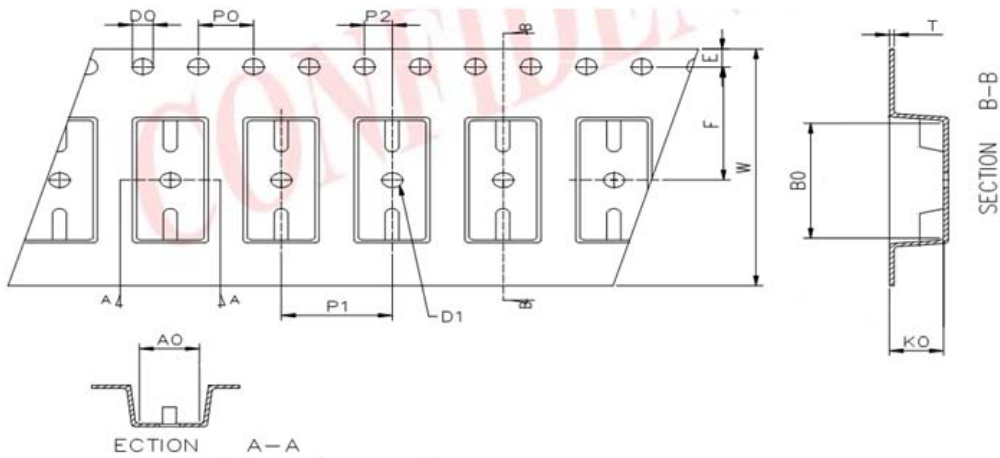

Dimension No.	Ao	Bo	Do	D1	E	F
Dimension(mm) S1	4.90±0.1	10.40±0.1	1.5±0.1	1.50±0.1	1.75±0.1	7.50±0.1
Dimension No.	Po	P1	P2	t	W	Ko
Dimension(mm) S1	4.00±0.1	8.00±0.1	2.00±0.1	0.40±0.1	16.00±0.3	4.60±0.1

Precautions for Use

1. Soldering Condition

1.1 (A) Maximum Body Case Temperature Profile for evaluation of Reflow Profile

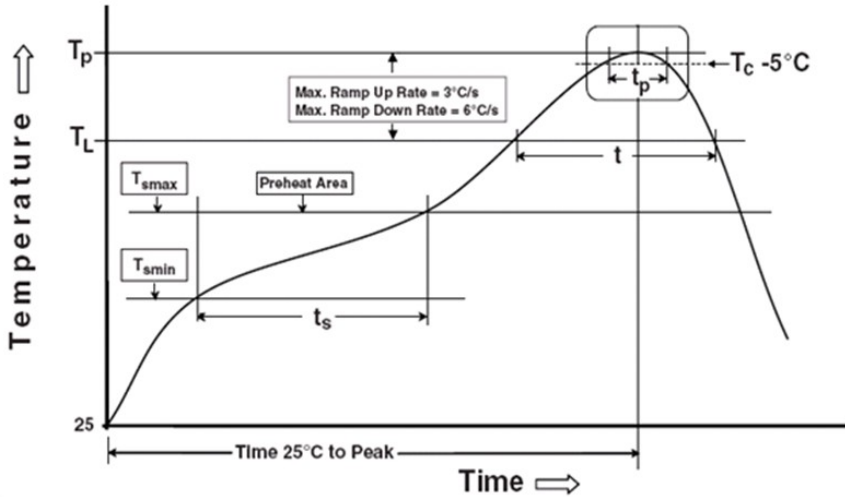

Note:

Reference: IPC/JEDEC J-STD-020D

Preheat

Temperature min (T_{smin})	150 °C
Temperature max (T_{smax})	200°C
Time (T_{smin} to T_{smax}) (t_s)	60-120 seconds
Average ramp-up rate (T_{smax} to T_p)	3 °C/second max

Other

Liquidus Temperature (T_L)	217 °C
Time above Liquidus Temperature (t_L)	60-100 sec
Peak Temperature (T_p)	260°C
Time within 5 °C of Actual Peak Temperature: $T_p - 5^\circ\text{C}$	30 s
Ramp- Down Rate from Peak Temperature	6°C /second max.
Time 25°C to peak temperature	8 minutes max.
Reflow times	3 times

Application Restrictions

High reliability applications such as military/aerospace, automotive safety/security systems, and medical equipment may require different product. If you have any concerns, please contact Everlight before using this product in your application. This specification guarantees the quality and performance of the product as an individual component. Do not use this product beyond the specification described in this document.