

50 Ohm SMC Right Angle Crimp Type Plug - Captivated Contact

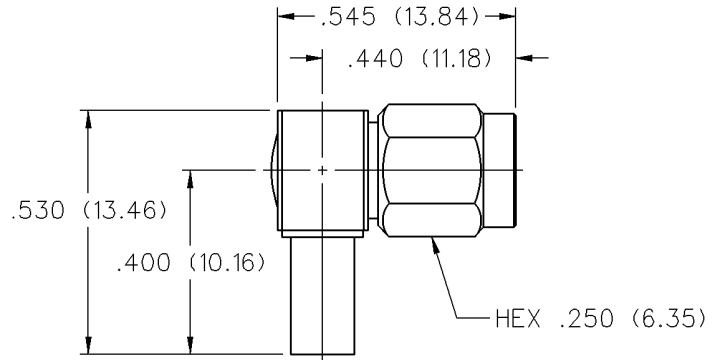

INCHES (MILLIMETERS)
CUSTOMER DRAWINGS AVAILABLE UPON REQUEST

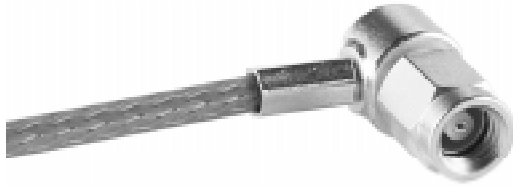

CABLE TYPE	GOLD PLATED	NICKEL PLATED
RG-179/U, 187	131-6433-101	131-6433-106

CABLE GROUP	PART NUMBER	"A"	"B"	CRIMP HEX
RG-179/u, 187	131-6433-101/106	.219 (5.56)	.312 (7.92)	.151 (3.83)

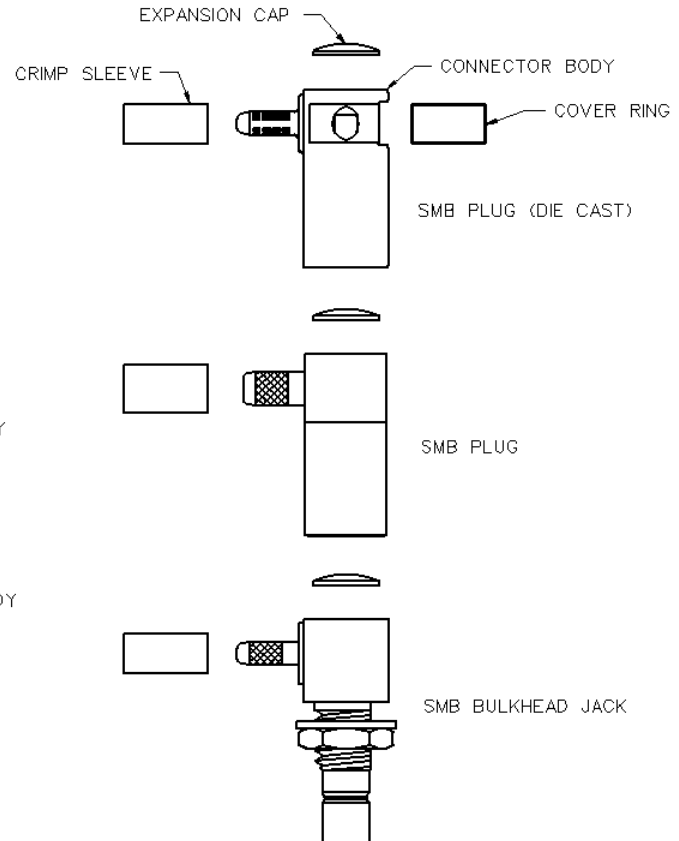
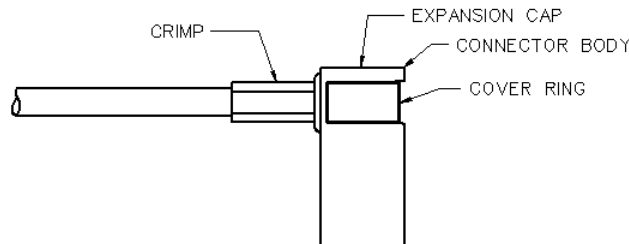
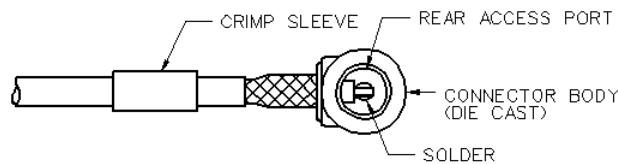
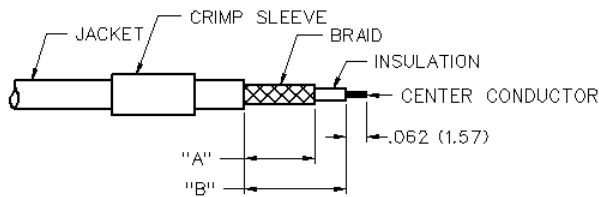

1. Identify connector parts. (4 piece parts: crimp sleeve, body assembly, expansion cap and covering ring. Die cast body only.)
2. Strip cable to dimensions shown. Do not nick braid or center conductor. A wire stripper of correct size is recommended for this step. Twist stranded center conductor into tight bundle and tin (optional). Slide crimp sleeve onto cable as shown.
3. Flare braid and slide cable into body assembly making certain that the cable insulation bottoms on center contact. Solder center conductor to contact through the rear and side access ports. Use a minimum amount of solder for a good joint. **.020 (0.51) diameter solder is recommended.**
4. Arrange braid uniformly around crimp stem of body assembly. Slide crimp sleeve over braid and crimp securely using recommended crimp tool. Place expansion cap in access port and seat with a .125 (3.17) diameter flat punch. Snap cover ring over side access port.

SMC - 50 Ohm Connectors



Specifications

INCHES (MILLIMETERS)
CUSTOMER DRAWINGS AVAILABLE UPON REQUEST

ELECTRICAL RATINGS

Impedance: 50 ohms
Frequency Range: 0-10 GHz
VSWR: (f = GHz)

	Straight Cabled	Right Angle Cabled
RG-178 cable	1.25 + .04f	1.40 + .06f
RG-316 and .086 semi-rigid cable	1.20 + .04f	1.30 + .04f
Uncabled receptacles	N/A	
Adapters	1.20 + .04f	

Working Voltage: (Vrms maximum)†

Connectors for Cable Type	Sea Level	70K Feet
RG-178	250	60
RG-316, .086 semi-rigid uncabled receptacles, adapters	335	85

Dielectric Withstanding Voltage: (VRMS minimum at sea level)†

Connectors for RG-178	750
Connectors for RG-316, .086 semi-rigid uncabled receptacles, adapters	1000

Corona Level: (Volts minimum at 70,000 feet)†

Connectors for RG-178	185
Connectors for RG-316, .086 semi-rigid	250
Uncabled receptacles and adapters	N/A

Insertion Loss: (dB maximum, tested at 4 GHz)

Straight cable connectors	0.25 dB
Right angle cable connectors	0.50 dB
Uncabled receptacles and adapters	N/A

Insulation Resistance: 1000 megohms minimum

Contact Resistance: (milliohms maximum)

	Initial	After Environmental
Center contact (straight cabled connectors and uncabled receptacles)	6.0	8.0
Center contact (right angle cabled connectors and adapters)	12.0	16.0
Outer contact (gold plated connectors)	1.0	N/A
Outer contact (nickel plated connectors)	2.5	N/A
Braid to body (gold plated connectors)	1.0	N/A
Braid to body (nickel plated connectors)	2.5	N/A

RF Leakage: (dB minimum tested at 2.5 GHz)

Cable connectors	-55 dB
Uncabled receptacles and adapters	N/A

† All gold plated parts include a .00005" min. nickel underplate barrier layer.

Avoid user injury due to misapplication. See safety advisory definitions inside front cover.

RF High Potential Withstanding Voltage: (Vrms minimum, tested at 4 and 7 MHz)†

Connectors for RG-178	500
Connectors for RG-316	700
Uncabled receptacles and adapters	600

MECHANICAL RATINGS

Engagement Design: MIL-C-39012, Series SMC
Engagement/Disengagement Force: 16 inch-ounce maximum torque
Mating Torque: 35 to 50 inch-ounce
Coupling Proof Torque: 100 inch-ounce minimum
Coupling Nut Retention: 35 pounds minimum
Contact Retention: 4 lbs. minimum axial force (captivated contacts)
1 inch-ounce minimum torque (uncabled receptacles)

Cable Retention:	Axial Force* (pounds)	Torque (in-oz)
Connectors for RG-178	10	N/A
Connectors for RG-316	20	N/A
Connectors for .086 semi-rigid	30	16

* or cable breaking strength whichever is less

Durability: 500 cycles minimum

ENVIRONMENTAL RATINGS (Meets or exceeds the applicable paragraph of MIL-C-39012)

Temperature Range: - 65°C to + 165°C

Thermal Shock: MIL-STD-202, Method 107, Condition B

Corrosion: MIL-STD-202, Method 101, Condition B

Shock: MIL-STD-210, Method 213, Condition C

Vibration: MIL-STD-202, Method 204, Condition D

MATERIAL SPECIFICATIONS

Bodies: Brass per QQ-B-626, gold plated** per MIL-G-45204 .00001" min or nickel plated per QQ-N-290

Contacts: Male - brass per QQ-B-626, gold plated per MIL-G-45204 .00003" min.

Female - beryllium copper per QQ-C-530, gold plated per MIL-G-45204 .00003" min.

Nut Retention Spring: Beryllium copper per QQ-C-533, unplated

Insulators: PTFE fluorocarbon per ASTM D 1710 and ASTM D 1457

Expansion Caps: Brass per QQ-B-613, gold plated per MIL-G-45204 .00001" min. or nickel plated per QQ-N-290

Crimp Sleeves: Copper per WW-T-799, gold plated per MIL-G-45204 .00001" min. or nickel plated per QQ-N-290

Mounting Hardware: Brass (nuts) per QQ-B-626 or phosphor bronze (lockwashers) per QQ-B-750, gold plated per MIL-G-45204 .00001" min. or nickel plated per QQ-N-290

MATING ENGAGEMENT FOR SMC SERIES PER MIL-C-39012

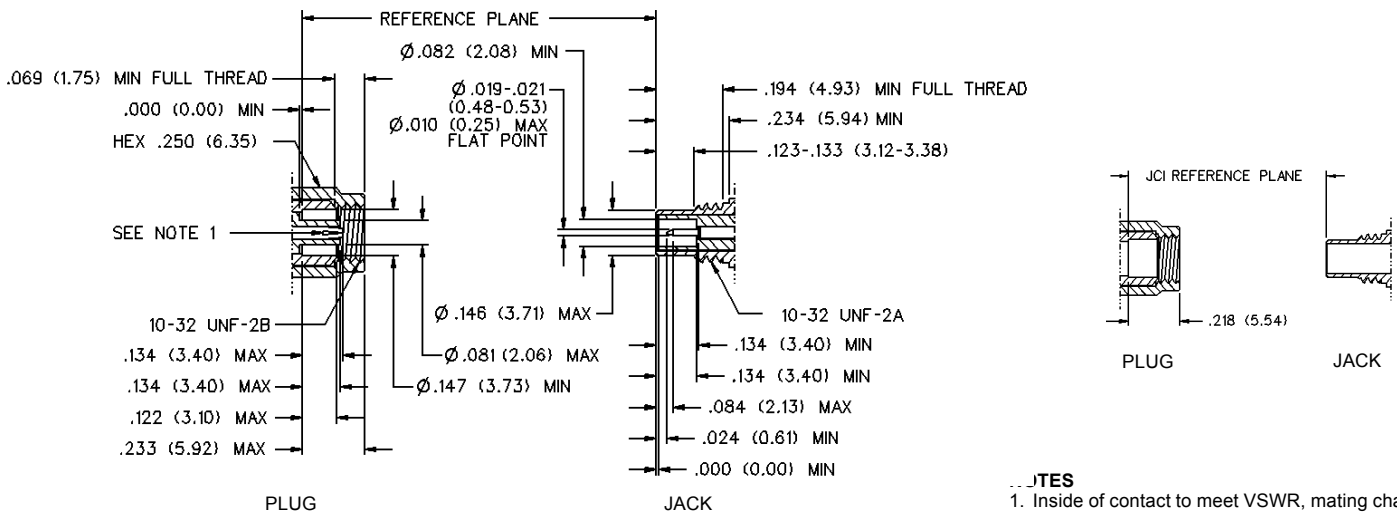

NOTES

1. Inside of contact to meet VSWR, mating characteristics and connector durability when mated with a dia .019/.021 (0.48/0.53) male contact.