

SPECIFICATIONS:
 RATING: 12VDC @ 1 A
 LIFE: 5,000 CYCLES MIN
 INSULATION RESISTANCE: 100 MOHM MIN @ 500V DC
 DIELECTRIC STRENGTH: 500V AC/RMS, 1 MINUTE
 CONTACT RESISTANCE: 50 MOHM MAX
 INSERTION FORCE: 0.5~5.0 KG
 EXTRACTION FORCE: 0.5~5.0 KG
 SOLDERING TEMP: 245 ±5 °C FOR 5 ±1 SECOND
 RESISTANCE TO SOLDERING HEAT: 260 ±5 C FOR 5 ± 1 SEC.
 OPERATING TEMP: -25~+70 °C

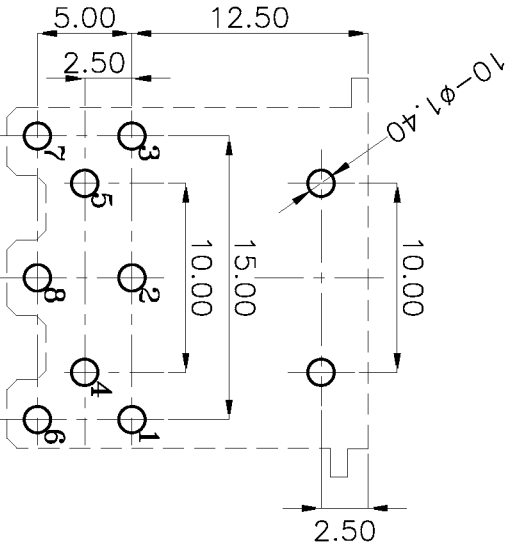
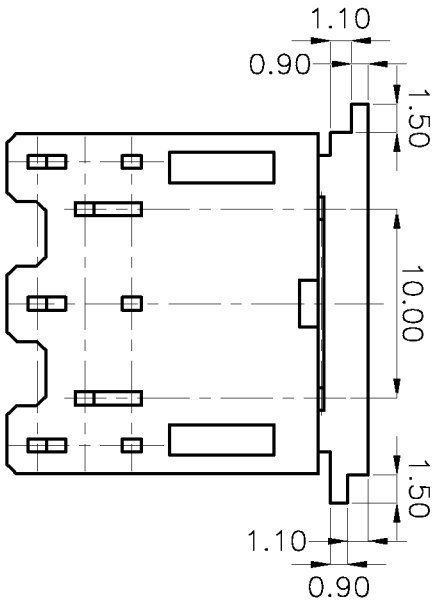

9615 SW Allen, Suite 103
 Beaverton, OR 97005
 Phone: (503) 643-4899
 800-275-4899
 Fax: (503) 643-6129
 Website: www.cuistack.com

TITLE: STANDARD DIN JACK W/O SHIELD

PART NO: SDPE-80J UNITS: Millimeters

SCALE: 2.5X
 DRAWN BY: Todd R. White
 APPROVED BY:

PC FILE NAME: SDPE_80J.DWG

COPYRIGHT 1998 BY CUI STACK, INC.