

TWO HOLE HYLUG™ FLEX CONDUCTOR STANDARD BARREL LEAD PLATED

TYPE YAG-L-2TC-LD

COPPER COMPRESSION
TERMINAL

UL Listed 90° C,
600 Volts to 35 KV ◆

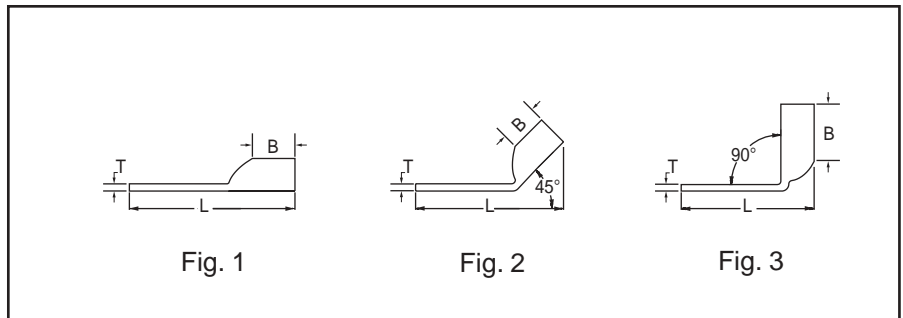
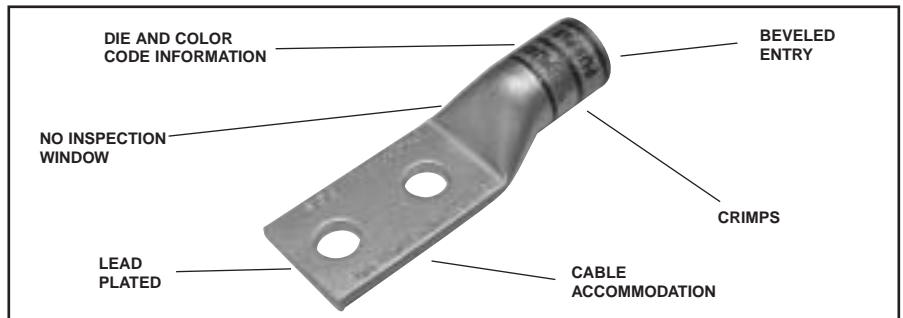

C-71

Catalog Number	Fig #	Conductor		Stud Hole Size	Stud Hole Spacing	Tongue Width	Figure Dimensions			▲ Installation Tooling																					
		AWG	MM ²				(B)	(T)	(L)	Dieless (# of crimps)	Mechanical	Hydraulic		Color Code	Die Index	Wire Strip Length															
											MD6, OUR840, MD7-34R	BCT500HS, Y500CTHS	Y35, Y39, Y750, Y46*, PAT750																		
YAG8CL-2TC14-LD	1	#8 WELD	10	1/4"	5/8"	.41"	.44"	.08"	MRC840 (1) MY29-3 (1) MY29-11 (1) Y8MRB-1 (1) Y2MR (1) Y1MR (1)	W8CVT	W8CVT	U8CRT	Red	49	1/2"																
YAG8CL-2TC14-LD-45	2															1.95"															
YAG8CL-2TC14-LD-90	3															1.94"															
YAG8CL-2TC38-LD	1															1.00"															
YAG8CL-2TC38-LD-45	2															2.52"															
YAG8CL-2TC38-LD-90	3															2.46"															
YAG8CL-2TC10-LD	1			37/24	# 10	5/8"	.41"	.44"		.08"	1.84"	W8CVT (1) W8CRT (1) X8CRT (1)	W8CVT (1) W8CRT (1) X8CRT (1)	U8CRT (1)	Red	49	7/16"														
YAG8CL-2TC10-LD-45	2																	2.05"													
YAG8CL-2TC10-LD-90	3																	1.83"													
YAG8CL-2TC14E1-LD	1																	#8 AWG	10	1/4"	1"	.44"	.44"	.08"	2.33"	W8CVT (1) W8CRT (1) X8CRT (1)	U8CRT (1)	Red	49	7/16"	
YAG8CL-2TC14E1-LD-45	2																														2.32"
YAG8CL-2TC14E1-LD-90	3																														1.87"
YAG8CL-2TC14E2-LD	1	1/4"	3/4"	.44"	.44"	.08"	2.08"	MY29-11 (1) Y2MR (1) Y644M (1) Y1MR (1)	W5CVT (1) W5CRT (1) X5CRT (1)	W5CVT (1) W5CRT (1) X5CRT (1)	U5CRT (1)	Blue	7	1/2"																	
YAG8CL-2TC14E2-LD-45	2														2.07"																
YAG8CL-2TC14E2-LD-90	3														1.62"																
YAG6CL-2TC10-LD	1														#6 WELD	16	# 10	5/8"	.44"	.50"	.07"	W5CVT (1) W5CRT (1) X5CRT (1)	W5CVT (1) W5CRT (1) X5CRT (1)	U5CRT (1)	Blue	7	1/2"				
YAG6CL-2TC10-LD-45	2																											1.94"			
YAG6CL-2TC10-LD-90	3																											1.86"			
YAG6CL-2TC10E2-LD	1	1.38"																													
YAG6CL-2TC10E2-LD-45	2	2.06"																													
YAG6CL-2TC10E2-LD-90	3	2.02"																													
YAG6CL-2TC10E4-LD	1	# 10	11/16"	.44"	.50"	.07"	1.57"	2.00"	W5CVT (1) W5CRT (1) X5CRT (1)	W5CVT (1) W5CRT (1) X5CRT (1)	U5CRT (1)	Blue	7	1/2"																	
YAG6CL-2TC10E4-LD-45	2																1.95"														
YAG6CL-2TC10E4-LD-90	3																1.44"														
YAG6CL-2TC10E-LD	1																#6 AWG	1/2"	.48"	.50"	.08"	1.81"	1.77"	W5CVT (1) W5CRT (1) X5CRT (1)	W5CVT (1) W5CRT (1) X5CRT (1)	U5CRT (1)	Blue	7	1/2"		
YAG6CL-2TC10E-LD-45	2																													1.81"	
YAG6CL-2TC10E-LD-90	3																													1.27"	
YAG6CL-2TC14-LD	1	1/4"	5/8"	.48"	.50"	.08"	2.06"	2.44"	W5CVT (1) W5CRT (1) X5CRT (1)	W5CVT (1) W5CRT (1) X5CRT (1)	U5CRT (1)	Blue	7	1/2"																	
YAG6CL-2TC14-LD-45	2														2.02"																
YAG6CL-2TC14-LD-90	3														1.52"																
YAG6CL-2TC14E1-LD	1														1/4"	1"	.48"	.50"	.08"	2.44"	2.40"	W5CVT (1) W5CRT (1) X5CRT (1)	W5CVT (1) W5CRT (1) X5CRT (1)	U5CRT (1)	Blue	7	1/2"				
YAG6CL-2TC14E1-LD-45	2																											2.40"			
YAG6CL-2TC14E1-LD-90	3																											1.89"			

* Use PUADP-1 adapter with "U" dies in Y46 HYPRESS™.
 ** The MM² conductor size referenced here is for both Class 2 and Class 5 conductor.

*** The MM² conductor sizes listed are the recommendations for Class 5 conductor.
 ◆ For applications greater than 2000 Volts consult cable manufacturer for voltage stress relief instructions.

TWO HOLE HYLUG™ FLEX CONDUCTOR STANDARD BARREL LEAD PLATED (Continued)

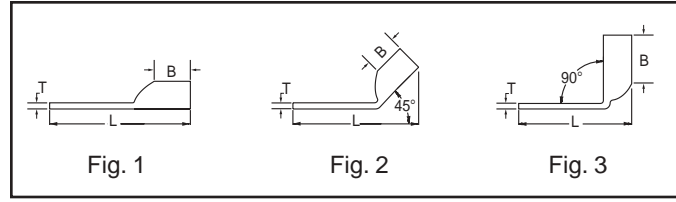

C-72

Catalog Number	Fig #	Conductor					▲ Installation Tooling										
		AWG	*** MM ²	Stud Hole Size	Stud Hole Spacing	Tongue Width	Figure Dimensions			Dieless (# of crimps)	Mechanical		Hydraulic		Color Code	Die Index	Wire Strip Length
							(B)	(T)	(L)		MD6, OUR840, MD7-34R	BCT500HS, Y500CTHS	Y35, Y39, Y750, Y46*, PAT750				
YAG6CL-2TC14E2-LD	1	#6 WELD 61/24 #6 AWG	16	1/4"	3/4"	.48"	.50"	.08"	2.18"	MY29-11 (1) Y2MR (1) Y644M (1) Y1MR (1)	W5CVT (1) W5CRT (1) X5CRT (1)	W5CVT (1) W5CRT (1) X5CRT (1)	U5CRT (1)	Blue	7	1/2"	
YAG6CL-2TC14E2-LD-45	2						.50"	.08"	2.15"								
YAG6CL-2TC14E2-LD-90	3						.50"	.08"	1.64"								
YAG6CL-2TC516-LD	1			5/16"	1"	.52"	.50"	.07"	2.50"								
YAG6CL-2TC516-LD-45	2						.50"	.07"	2.45"								
YAG6CL-2TC516-LD-90	3						.50"	.07"	1.95"								
YAG6CL-2TC38-LD	1			3/8"	1"	.58"	.50"	.06"	2.62"								
YAG6CL-2TC38-LD-45	2						.50"	.06"	2.56"								
YAG6CL-2TC38-LD-90	3						.50"	.06"	2.07"								
YAG6CL-2NTC-LD	1			1/2"	1-3/4"	.83"	.50"	.12"	3.81"								
YAG6CL-2NTC-LD-45	2	.50"	.12"				3.67"										
YAG6CL-2NTC-LD-90	3	.50"	.12"				3.29"										
YAG4CL-2NT10-LD	1	#4 WELD 91/24 105/24 #4 AWG	-	# 10	5/8"	.41"	.50"	.09"	1.99"	MY29-11 (1) Y2MR (2) Y644M (1) Y1MR (2)	W4CVT (1) W4CRT (1) X4CRT (1)	W4CVT (1) W4CRT (1) X4CRT (1)	U4CRT (1)	Gray	8	1/2"	
YAG4CL-2NT10-LD-45	2						.50"	.09"	1.97"								
YAG4CL-2NT10-LD-90	3						.50"	.09"	1.43"								
YAG4CL-2NT10E1-LD	1			# 10	1"	.41"	.50"	.09"	2.37"								
YAG4CL-2NT10E1-LD-45	2						.50"	.09"	2.34"								
YAG4CL-2NT10E1-LD-90	3						.50"	.09"	1.80"								
YAG4CL-2TC14-LD	1			1/4"	5/8"	.55"	.50"	.09"	2.11"								
YAG4CL-2TC14-LD-45	2						.50"	.09"	2.09"								
YAG4CL-2TC14-LD-90	3						.50"	.09"	1.55"								
YAG4CL-2TC14E2-LD	1			1/4"	3/4"	.55"	.50"	.09"	2.24"								
YAG4CL-2TC14E2-LD-45	2	.50"	.09"				2.22"										
YAG4CL-2TC14E2-LD-90	3	.50"	.09"				1.68"										
YAG4CL-2TC14E1-LD	1	1/4"	1"	.55"	.50"	.09"	2.49"										
YAG4CL-2TC14E1-LD-45	2				.50"	.09"	2.47"										
YAG4CL-2TC14E1-LD-90	3				.50"	.09"	1.93"										
YAG4CL-2TC38-LD	1	3/8"	1"	.58"	.50"	.08"	2.68"										
YAG4CL-2TC38-LD-45	2				.50"	.08"	2.64"										
YAG4CL-2TC38-LD-90	3				.50"	.08"	2.11"										
YAG4CL-2TC516-LD	1	5/16"	1"	.55"	.50"	.09"	2.56"										
YAG4CL-2TC516-LD-45	2				.50"	.09"	2.53"										
YAG4CL-2TC516-LD-90	3				.50"	.09"	1.99"										
YAG4CL-2NTC-LD	1	1/2"	1-3/4"	.83"	.50"	.12"	3.87"										
YAG4CL-2NTC-LD-45	2				.50"	.12"	3.91"										
YAG4CL-2NTC-LD-90	3				.50"	.12"	3.32"										
YAG2CL-2TC14-LD	1	#2 WELD 125/24 150/24 #2 AWG	35	1/4"	5/8"	.68"	.63"	.10"	2.28"	W2CVT (1) W2CRT (1) X2CRT (1)	W2CVT (1) W2CRT (1) X2CRT (1)	U2CRT (1)	Brown	10	11/16"		
YAG2CL-2TC14-LD-45	2						.63"	.10"	2.23"								
YAG2CL-2TC14-LD-90	3						.63"	.10"	1.60"								
YAG2CL-2TC14E1-LD	1			1/4"	1"	.68"	.63"	.10"	2.63"								
YAG2CL-2TC14E1-LD-45	2						.63"	.10"	2.60"								
YAG2CL-2TC14E1-LD-90	3						.63"	.10"	1.98"								
YAG2CL-2TC14E2-LD	1			1/4"	3/4"	.68"	.63"	.10"	2.40"								
YAG2CL-2TC14E2-LD-45	2						.63"	.10"	2.36"								
YAG2CL-2TC14E2-LD-90	3						.63"	.10"	1.73"								
YAG2CL-2TC38-LD	1			3/8"	1"	.68"	.63"	.10"	2.84"								
YAG2CL-2TC38-LD-45	2	.63"	.10"				2.79"										
YAG2CL-2TC38-LD-90	3	.63"	.10"				2.17"										

* Use PUADP-1 adapter with "U" dies in Y46 HYPRESS™.
 ** The 16 MM² referenced here is for both Class 2 and Class 5 conductor.

*** The MM² conductor sizes listed are the recommendations for Class 5 conductor.
 ◆ For applications greater than 2000 Volts consult cable manufacturer for voltage stress relief instructions.

TWO HOLE HYLUG™ FLEX CONDUCTOR STANDARD BARREL LEAD PLATED (Continued)

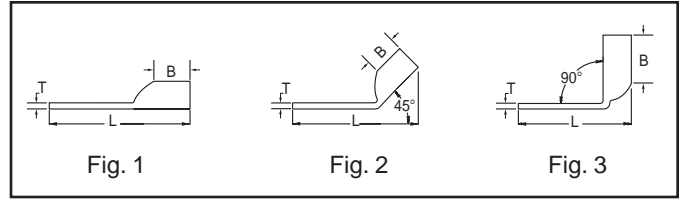

Catalog Number	Fig #	Conductor		Stud Hole Size	Stud Hole Spacing	Tongue Width	Figure Dimensions			Dieless (# of crimps)	▲ Installation Tooling					Wire Strip Length	
		AWG	*** MM ²				(B)	(T)	(L)		Mechanical MD6, OUR840, MD7-34R	Hydraulic		Color Code	Die Index		
												BCT500HS, Y500CTHS	Y35, Y39, Y750, Y46*, PAT750				
YAG2CL-2TC516-LD	1																
YAG2CL-2TC516-LD-45	2	#2 WELD		5/16"	1"	.68"	.63"	.10"	2.71"	MY29-11 (1) Y2MR (2) Y644M (1) Y1MR (2)	W2CVT (1) W2CRT (1) X2CRT (1)	W2CVT (1) W2CRT (1) X2CRT (1)	U2CRT (1)	Brown	10	11/16"	
YAG2CL-2TC516-LD-90	3	125/24							2.67"								
YAG2CL-2NTC-LD	1	150/24							2.04"								
YAG2CL-2NTC-LD-45	2	#2 AWG		1/2"	1-3/4"	.83"	.63"	.08"	4.03"								
YAG2CL-2NTC-LD-90	3								3.94"								
YAG1CL-2TC14-LD	1								2.37"	MY29-11 (1) Y644M (1)	W1CVT (1) W1CRT-1 (1) X1CRT-1 (1)	W1CVT (1) W1CRT-1 (1) X1CRT-1 (1)	U1CRT-1 (1)	Green	11	11/16"	
YAG1CL-2TC14-LD-45	2	#1 WELD		1/4"	5/8"	.75"	.69"	.12"	2.33"								
YAG1CL-2TC14-LD-90	3								1.64"								
YAG1CL-2TC14E2-LD	1								2.49"								
YAG1CL-2TC14E2-LD-45	2			1/4"	3/4"	.75"	.69"	.12"	2.46"								
YAG1CL-2TC14E2-LD-90	3								1.76"								
YAG1CL-2TC14E1-LD	1								2.73"								
YAG1CL-2TC14E1-LD-45	2			1/4"	1"	.75"	.69"	.12"	2.70"								
YAG1CL-2TC14E1-LD-90	3	175/24							2.00"								
YAG1CL-2TC516-LD	1	225/24							2.81"								
YAG1CL-2TC516-LD-45	2	#1 AWG		5/16"	1"	.75"	.69"	.12"	2.77"								
YAG1CL-2TC516-LD-90	3								2.08"								
YAG1CL-2TC38-LD	1								2.93"								
YAG1CL-2TC38-LD-45	2			3/8"	1"	.75"	.69"	.12"	2.90"								
YAG1CL-2TC38-LD-90	3								2.20"								
YAG1CL-2NTC-LD	1								4.12"								
YAG1CL-2NTC-LD-45	2			1/2"	1-3/4"	.83"	.69"	.11"	4.06"								
YAG1CL-2NTC-LD-90	3								3.38"								
YAG25L-2TC14-LD	1								2.41"	MY29-11 (1) Y644M (1)	W25VT (2) W25RT (2) X25RT (2)	W25VT (2) W25RT (2) X25RT (2)	U25RT (1)	Pink	12	11/16"	
YAG25L-2TC14-LD-45	2	#1 WELD		1/4"	5/8"	.83"	.69"	.12"	2.36"								
YAG25L-2TC14-LD-90	3								1.66"								
YAG25L-2TC14E2-LD	1								2.53"								
YAG25L-2TC14E2-LD-45	2			1/4"	3/4"	.83"	.69"	.12"	2.49"								
YAG25L-2TC14E2-LD-90	3								1.79"								
YAG25L-2TC516E2-LD	1								2.60"								
YAG25L-2TC516E2-LD-45	2			5/16"	3/4"	.83"	.69"	.12"	2.55"								
YAG25L-2TC516E2-LD-90	3	1/0 WELD							1.85"								
YAG25L-2TC516-LD	1								2.85"								
YAG25L-2TC516-LD-45	2	275/24	50	5/16"	1"	.83"	.69"	.12"	2.80"								
YAG25L-2TC516-LD-90	3								2.10"								
YAG25L-2TC38-LD	1	1/0 AWG							2.97"								
YAG25L-2TC38-LD-45	2			3/8"	1"	.83"	.69"	.12"	2.92"								
YAG25L-2TC38-LD-90	3								2.23"								
YAG25L-2NTC-LD	1								4.16"								
YAG25L-2NTC-LD-45	2			1/2"	1-3/4"	.83"	.69"	.12"	4.11"								
YAG25L-2NTC-LD-90	3								3.41"								
YAG25L-2TC12E1-LD	1								3.22"								
YAG25L-2TC12E1-LD-45	2			1/2"	1"	.83"	.69"	.12"	3.17"								
YAG25L-2TC12E1-LD-90	3								2.48"								
YAG26L-2TC14-LD	1	2/0 WELD							2.58"	MY29-11 (1) Y644M (1)	W26RT (2) W26VT (2) X26RT (2)	W26RT (2) W26VT (2) X26RT (2)	U26RT (1)	Black	13	13/16"	
YAG26L-2TC14-LD-45	2	325/24	70	1/4"	5/8"	.93"	.81"	.13"	2.51"								
YAG26L-2TC14-LD-90	3	2/0 AWG							1.70"								

C-73

* Use PUADP-1 adapter with "U" dies in Y46 HYPRESS™.
 *** The MM² conductor sizes listed are the recommendations for Class 5 conductor.

◆ For applications greater than 2000 Volts consult cable manufacturer for voltage stress relief instructions.

TWO HOLE HYLUG™ FLEX CONDUCTOR STANDARD BARREL LEAD PLATED (Continued)

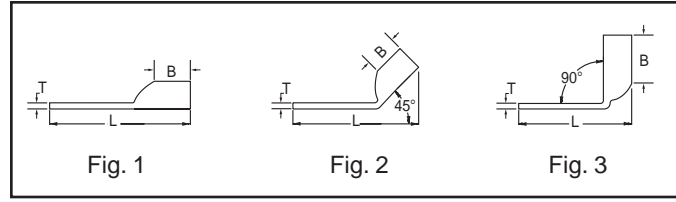

C-74

Catalog Number	Fig #	Conductor					▲ Installation Tooling						Wire Strip Length																					
		AWG	*** MM ²	Stud Hole Size	Stud Hole Spacing	Tongue Width	Figure Dimensions			Dieless (# of crimps)	Mechanical MD6, OUR840, MD7-34R	Hydraulic		Color Code	Die Index																			
							(B)	(T)	(L)			BCT500HS, Y500CTHS				Y35, Y39, Y750, Y46*, PAT750																		
YAG26L-2TC14E2-LD	1	2/0 WELD 325/24 2/0 AWG	70	1/4"	3/4"	.93"	.81"	.13"	2.71"	MY29-11 (1) Y644M (1)	W26RT (2) W26VT (2) X26RT (2)	W26RT (2) W26VT (2) X26RT (2)	U26RT (1)	Black	13	13/16"																		
YAG26L-2TC14E2-LD-45	2						.81"	.13"	2.63"																									
YAG26L-2TC14E2-LD-90	3						.81"	.13"	1.83"																									
YAG26L-2TC516-LD	1			3/0 WELD 450/24 3/0 AWG	95	5/16"	1"	.93"	.81"								.13"	3.02"	W27VT (2) W27RT (2) X27RT (3)	W27VT (2) W27RT (2) X27RT (3)	U27RT (1)	Orange	14	1.00 in.										
YAG26L-2TC516-LD-45	2								.81"								.13"	2.94"																
YAG26L-2TC516-LD-90	3								.81"								.13"	2.14"																
YAG26L-2TC38-LD	1					3/0 WELD 450/24 3/0 AWG	95	3/8"	1"								.93"	.81"							.13"	3.14"	MY29-11 (1) Y644M (1)	W27VT (2) W27RT (2) X27RT (3)	W27VT (2) W27RT (2) X27RT (3)	U27RT (1)	Orange	14	1.00 in.	
YAG26L-2TC38-LD-45	2																	.81"							.13"	3.39"								
YAG26L-2TC38-LD-90	3																	.81"							.13"	3.32"								
YAG26L-2NTC-LD	1							1/2"	1-3/4"								.93"	.81"							.13"	4.33"								
YAG26L-2NTC-LD-45	2	.81"	.13"							4.26"																								
YAG26L-2NTC-LD-90	3	.81"	.13"							3.45"																								
YAG27L-2TC14-LD	1	3/0 WELD 450/24 3/0 AWG	95	1/4"	5/8"	1.03"	1.00"	.14"	2.81"	MY29-11 (1) Y644M (1)	W27VT (2) W27RT (2) X27RT (3)	W27VT (2) W27RT (2) X27RT (3)	U27RT (1)	Orange	14	1.00 in.																		
YAG27L-2TC14-LD-45	2						1.00"	.14"	2.67"																									
YAG27L-2TC14-LD-90	3						1.00"	.14"	1.74"																									
YAG27L-2TC14E2-LD	1			3/0 WELD 450/24 3/0 AWG	95	1/4"	3/4"	1.03"	1.00"								.14"	2.94"	MY29-11 (1) Y644M (1)	W27VT (2) W27RT (2) X27RT (3)	W27VT (2) W27RT (2) X27RT (3)	U27RT (1)	Orange	14	1.00 in.									
YAG27L-2TC14E2-LD-45	2								1.00"								.14"	2.82"																
YAG27L-2TC14E2-LD-90	3								1.00"								.14"	1.86"																
YAG27L-2TC516-LD	1					3/0 WELD 450/24 3/0 AWG	95	5/16"	1"								1.03"	1.00"								.14"	3.25"	MY29-11 (1) Y644M (1)	W27VT (2) W27RT (2) X27RT (3)	W27VT (2) W27RT (2) X27RT (3)	U27RT (1)	Orange	14	1.00 in.
YAG27L-2TC516-LD-45	2																	1.00"								.14"	3.13"							
YAG27L-2TC516-LD-90	3																	1.00"								.14"	2.18"							
YAG27L-2TC38-LD	1							3/8"	1"								1.03"	1.00"								.14"	3.38"							
YAG27L-2TC38-LD-45	2	1.00"	.14"							3.25"																								
YAG27L-2TC38-LD-90	3	1.00"	.14"							2.30"																								
YAG27L-2NTC-LD	1	1/2"	1-3/4"	1.03"	1.00"	.14"	4.56"																											
YAG27L-2NTC-LD-45	2				1.00"	.14"	4.44"																											
YAG27L-2NTC-LD-90	3				1.00"	.14"	3.49"																											
YAG28L-2TC14-LD	1	4/0 WELD 550/24 4/0 AWG	120	1/4"	5/8"	1.14"	1.03"	.15"	2.90"	MY29-11 (1) Y644M (1)	W28VT (2) W28RT (2) X28RT (3)	W28VT (2) W28RT (2) X28RT (3)	U28RT (1)	Purple	15	1-1/16"																		
YAG28L-2TC14-LD-45	2						1.03"	.15"	2.76"																									
YAG28L-2TC14-LD-90	3						1.03"	.15"	1.78"																									
YAG28L-2TC14E2-LD	1			4/0 WELD 550/24 4/0 AWG	120	1/4"	3/4"	1.14"	1.03"								.15"	3.02"	MY29-11 (1) Y644M (1)	W28VT (2) W28RT (2) X28RT (3)	W28VT (2) W28RT (2) X28RT (3)	U28RT (1)	Purple	15	1-1/16"									
YAG28L-2TC14E2-LD-45	2								1.03"								.15"	2.89"																
YAG28L-2TC14E2-LD-90	3								1.03"								.15"	1.90"																
YAG28L-2TC516-LD	1					4/0 WELD 550/24 4/0 AWG	120	5/16"	1"								1.14"	1.03"								.15"	3.33"	MY29-11 (1) Y644M (1)	W28VT (2) W28RT (2) X28RT (3)	W28VT (2) W28RT (2) X28RT (3)	U28RT (1)	Purple	15	1-1/16"
YAG28L-2TC516-LD-45	2																	1.03"								.15"	3.20"							
YAG28L-2TC516-LD-90	3																	1.03"								.15"	2.22"							
YAG28L-2TC38-LD	1							3/8"	1"								1.14"	1.03"								.15"	3.46"							
YAG28L-2TC38-LD-45	2	1.03"	.15"							3.33"																								
YAG28L-2TC38-LD-90	3	1.03"	.15"							2.34"																								
YAG28L-2NT38-LD	1	3/8"	1"	.94"	1.03"	.17"	3.48"																											
YAG28L-2NT38-LD-45	2				1.03"	.17"	3.38"																											
YAG28L-2NT38-LD-90	3				1.03"	.17"	2.36"																											
YAG28L-2TC12E1-LD	1	1/2"	1"	1.14"	1.03"	.17"	3.71"																											
YAG28L-2TC12E1-LD-45	2				1.03"	.17"	3.58"																											
YAG28L-2TC12E1-LD-90	3				1.03"	.17"	2.59"																											
YAG28L-2TC12-LD	1	1/2"	1-1/4"	1.14"	1.03"	.17"	3.96"																											
YAG28L-2TC12-LD-45	2				1.03"	.17"	3.83"																											
YAG28L-2TC12-LD-90	3				1.03"	.17"	2.84"																											

* Use PUADP-1 adapter with "U" dies in Y46 HYPRESS™.
 ** The 120 MM² referenced here is for both Class 2 and Class 5 conductor.
 *** The MM² conductor sizes listed are the recommendations for Class 5 conductor.

◆ For applications greater than 2000 Volts consult cable manufacturer for voltage stress relief instructions.

TWO HOLE HYLUG™ FLEX CONDUCTOR STANDARD BARREL LEAD PLATED (Continued)

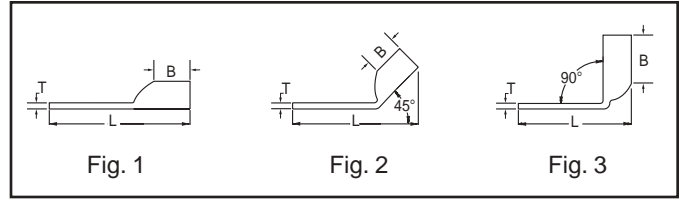

Catalog Number	Fig #	Conductor		Stud Hole Size	Stud Hole Spacing	Tongue Width	Figure Dimensions			Dieless (# of crimps)	▲ Installation Tooling				Wire Strip Length				
		AWG	*** MM ²				(B)	(T)	(L)		Mechanical		Hydraulic			Color Code	Die Index		
											MD6, OUR840, MD7-34R	BCT500HS, Y500CTHS	Y35, Y39, Y750, Y46*, PAT750						
YAG28L-2NTC-LD	1	4/0 WELD	** 120	1/2"	1-3/4"	1.14"	1.03"	.15"	4.65"	MY29-11(1) Y644M (1)	W28VT (2) W28RT (2) X28RT (3)	W28VT (2) W28RT (2) X28RT (3)	U28RT (1)	Purple	15	1-1/16"			
YAG28L-2NTC-LD-45	2	550/24															2.90"	4.51"	
YAG28L-2NTC-LD-90	3	4/0 AWG																	2.76"
YAG29L-2TC14-LD	1	4/0 WELD	1/4"	5/8"	1.14"	1.03"	.16"	2.90"	Y644M (1)	W29VT (2) W29RT (4)	W29VT (2) W29RT (2) X29RT (4)	U29RT (1)	Yellow	16	1-1/16"				
YAG29L-2TC14-LD-45	2															2.76"	1.78"		
YAG29L-2TC14-LD-90	3																	3.02"	2.89"
YAG29L-2TC14E2-LD	1		1/4"	3/4"	1.14"	1.03"	.16"	2.89"											
YAG29L-2TC14E2-LD-45	2															3.33"	3.20"		
YAG29L-2TC14E2-LD-90	3																	5/16"	1"
YAG29L-2TC516-LD	1		3.46"	3.33"															
YAG29L-2TC516-LD-45	2				3/8"	1"	1.14"	1.03"								.16"	3.33"		
YAG29L-2TC516-LD-90	3																	3.48"	3.38"
YAG29L-2TC38-LD	1		550/24	3/8"															
YAG29L-2TC38-LD-45	2				3.71"	3.58"													
YAG29L-2TC38-LD-90	3						1/2"	1"								1.14"	1.03"	.16"	3.58"
YAG29L-2NT38-LD	1	3.96"	3.83"																
YAG29L-2NT38-LD-45	2			1/2"	1"	1.14"			1.03"	.16"	3.58"	2.59"							
YAG29L-2NT38-LD-90	3						1/2"	1-1/4"					1.14"	1.03"	.16"	3.83"	2.84"		
YAG29L-2TC12E1-LD	1	4.65"	4.51"																
YAG29L-2TC12E1-LD-45	2			1/2"	1-3/4"	1.14"			1.03"	.16"	4.51"	3.53"							
YAG29L-2TC12E1-LD-90	3						3.48"	3.38"											
YAG29L-2TC12-LD	1	250 kcmil	3/8"										1"	1.20"	1.03"	.16"	3.38"	2.37"	
YAG29L-2TC12-LD-45	2			CLASS G 259 STR	1/2"	1-1/4"			1.20"	1.03"	.16"	3.88"							2.87"
YAG29L-2TC12-LD-90	3						CLASS H 427 STR	1/2"											
YAG29L-2NTC-LD	1	1/2"	1-3/4"										1.20"	1.03"	.16"	4.67"	4.57"		
YAG29L-2NTC-LD-45	2			3.56"	3.54"														
YAG29L-2NTC-LD-90	3					250 WELD	3/8"	1"	1.29"	1.06"	.18"	3.54"						3.46"	
YAG30L-2TC38-LD	1	637/24	3/8"										1"	1.29"	1.06"	.18"	3.46"		2.41"
YAG30L-2TC38-LD-45	2			CLASS I,K,M	1/2"														
YAG30L-2TC38-LD-90	3					1/2"	1-3/4"	1.29"	1.06"	.18"	3.46"	2.41"							
YAG30L-2TC12-LD	1	3.98"	3.88"																
YAG30L-2TC12-LD-45	2			3.88"	2.87"														
YAG30L-2TC12-LD-90	3					3.88"	2.87"												
YAG30L-2NTC-LD	1	3.88"	2.87"																
YAG30L-2NTC-LD-45	2			3.88"	2.87"														
YAG30L-2NTC-LD-90	3					3.56"	3.54"												
YAG31L-2TC38-LD	1	250 WELD	3/8"					1"	1.29"	1.06"	.18"	3.54"	3.46"						
YAG31L-2TC38-LD-45	2			637/24	3/8"									1-3/4"	1.29"	1.06"	.18"	3.46"	2.41"
YAG31L-2TC38-LD-90	2					CLASS I,K,M	1/2"												
YAG31L-2NTC38-LD	1	1/2"	1-3/4"					1.29"	1.06"	.18"	3.46"	2.41"							
YAG31L-2NTC38-LD-45	2			3.40"	4.20"														
YAG31L-2NTC38-LD-90	3					3.20"	4.04"												
YAG31L-2TC12-LD	1	3.20"	4.04"																
YAG31L-2TC12-LD-45	2			3.96"	2.91"														
YAG31L-2TC12-LD-90	3					4.73"	4.64"												
YAG31L-2NTC-LD	1	1/2"	1-3/4"					1.29"	1.06"	.18"	3.60"	3.60"							
YAG31L-2NTC-LD-45	2			3.60"	3.60"														
YAG31L-2NTC-LD-90	3					3.60"	3.60"												

C-75

* Use PUADP-1 adapter with "U" dies in Y46 HYPRESS™.
 ** The 120 MM² referenced here is for both Class 2 and Class 5 conductor.

*** The MM² conductor sizes listed are the recommendations for Class 5 conductor.
 ◆ For applications greater than 2000 Volts consult cable manufacturer for voltage stress relief instructions.

TWO HOLE HYLUG™ FLEX CONDUCTOR STANDARD BARREL LEAD PLATED (Continued)

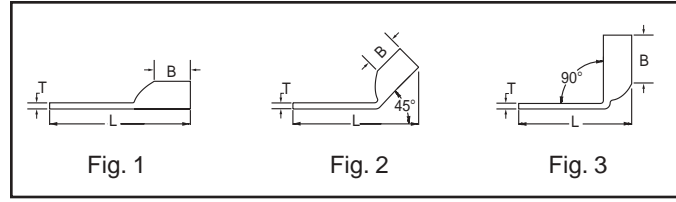

C-76

Catalog Number	Fig #	Conductor					Figure Dimensions			▲ Installation Tooling							
		AWG	*** MM ²	Stud Hole Size	Stud Hole Spacing	Tongue Width	(B)	(T)	(L)	Dieless (# of crimps)	Mechanical		Hydraulic		Color Code	Die Index	Wire Strip Length
											MD6, OUR840, MD7-34R	BCT500HS, Y500CTHS	Y35, Y39, Y750, Y46*, PAT750				
YAG32L-2TC38-LD	1	775/24	185	3/8"	1"	1.40"	1.19"	.19"	3.73"	Y644M (1)	W31VT (2)	W31VT (2) W31RT (2)	U31RT (2)	Red	18	1-1/4"	
YAG32L-2TC38-LD-45	2						3.62"										
YAG32L-2TC38-LD-90	3						2.45"										
YAG32L-2NTC-LD	1	313.1 kcmil	185	1/2"	1-3/4"	1.40"	1.19"	.19"	4.81"	Y644M (1)	W31VT (2)	W31VT (2) W31RT (2)	U31RT (2)	Red	18	1-1/4"	
YAG32L-2NTC-LD-45	2						3.79"										
YAG32L-2NTC-LD-90	3						3.64"										
YAG34L-2TC516-LD	1	373.7 kcmil	240	5/16"	1"	1.55"	1.27"	.23"	3.72"	Y644M (1)	W32VT (2)	W32VT (2) W32RT (2)	U32RT (2)	Blue	19	1-5/16"	
YAG34L-2TC516-LD-45	2						2.42"										
YAG34L-2TC516-LD-90	3						2.42"										
YAG34L-2TC38-LD	1	360 kcmil CLASS I	240	3/8"	1"	1.55"	1.27"	.23"	3.92"	Y644M (1)	W32VT (2)	W32VT (2) W32RT (2)	U32RT (2)	Blue	19	1-5/16"	
YAG34L-2TC38-LD-45	2						3.84"										
YAG34L-2TC38-LD-90	3						2.54"										
YAG34L-2NT38-LD	1	360 kcmil CLASS I	240	3/8"	1-3/4"	.96"	1.27"	.23"	4.67"	Y644M (1)	W32VT (2)	W32VT (2) W32RT (2)	U32RT (2)	Blue	19	1-5/16"	
YAG34L-2NT38-LD-45	2						4.59"										
YAG34L-2NT38-LD-90	3						3.29"										
YAG34L-2TC12-LD	1	360 kcmil CLASS I	240	1/2"	1-1/4"	1.55"	1.27"	.23"	4.42"	Y644M (1)	W32VT (2)	W32VT (2) W32RT (2)	U32RT (2)	Blue	19	1-5/16"	
YAG34L-2TC12-LD-45	2						3.34"										
YAG34L-2TC12-LD-90	3						3.04"										
YAG34L-2NTC-LD	1	360 kcmil CLASS I	240	1/2"	1-3/4"	1.55"	1.27"	.23"	5.11"	Y644M (1)	W32VT (2)	W32VT (2) W32RT (2)	U32RT (2)	Blue	19	1-5/16"	
YAG34L-2NTC-LD-45	2						5.03"										
YAG34L-2NTC-LD-90	3						3.73"										
YAG36L-2TC38-LD	1	1100/24	-	3/8"	1"	1.73"	1.38"	.27"	4.28"	Y644M (1)	-	-	U34RT (2)	Brown	20	1-3/8"	
YAG36L-2TC38-LD-45	2						4.24"										
YAG36L-2TC38-LD-90	3						2.81"										
YAG36L-2NTC-LD	1	444.4 kcmil	-	1/2"	1-3/4"	1.73"	1.38"	.27"	5.28"	Y644M (1)	-	-	U34RT (2)	Brown	20	1-3/8"	
YAG36L-2NTC-LD-45	2						5.24"										
YAG36L-2NTC-LD-90	3						3.81"										
YAG38L-2TC516-LD	1	535.3 kcmil	300	5/16"	1"	1.82"	1.45"	.27"	4.09"	Y644M (1)	-	-	U38XRT (2)	Pink	20	1-3/8"	
YAG38L-2TC516-LD-45	2						4.02"										
YAG38L-2TC516-LD-90	3						2.53"										
YAG38L-2NT38-LD	1	1325/24	300	3/8"	1"	1.63"	1.45"	.27"	4.40"	Y644M (1)	-	-	U38XRT (2)	Pink	20	1-3/8"	
YAG38L-2NT38-LD-45	2						4.33"										
YAG38L-2NT38-LD-90	3						2.84"										
YAG38L-2TC38-LD	1	500 kcmil CLASS I	300	3/8"	1"	1.82"	1.45"	.27"	4.28"	Y644M (1)	-	-	U38XRT (2)	Pink	20	1-3/8"	
YAG38L-2TC38-LD-45	2						4.24"										
YAG38L-2TC38-LD-90	3						2.81"										
YAG38L-2TC12-LD	1	500 kcmil CLASS I	300	1/2"	1-1/4"	1.82"	1.45"	.27"	4.72"	Y644M (1)	-	-	U38XRT (2)	Pink	20	1-3/8"	
YAG38L-2TC12-LD-45	2						4.64"										
YAG38L-2TC12-LD-90	3						3.16"										
YAG38L-2NTC-LD	1	500 kcmil CLASS I	300	1/2"	1-3/4"	1.82"	1.45"	.27"	5.28"	Y644M (1)	-	-	U38XRT (2)	Pink	20	1-3/8"	
YAG38L-2NTC-LD-45	2						5.24"										
YAG38L-2NTC-LD-90	3						3.81"										
YAG39L-2NTC-LD	1	600 kcmil	-	1/2"	1-3/4"	1.90"	1.19"	.27"	5.29"	Y644M (1)	-	-	U38RT (2)	Purple	400	1-3/8"	
YAG39L-2NTC-LD-45	2						5.26"										
YAG39L-2NTC-LD-90	3						3.87"										
YAG40L-2TC38-LD	1	646 kcmil 1600/24	400	3/8"	1"	1.98"	1.42"	.30"	4.33"	Y644M (1)	-	-	U39RT (2)	Black	24	1-5/16"	
YAG40L-2TC38-LD-45	2						4.23"										
YAG40L-2TC38-LD-90	3						2.72"										

* Use PUADP-1 adapter with "U" dies in Y46 HYPRESS™.
 *** The MM² conductor sizes listed are the recommendations for Class 5 conductor.

◆ For applications greater than 2000 Volts consult cable manufacturer for voltage stress relief instructions.

TWO HOLE HYLUG™ FLEX CONDUCTOR STANDARD BARREL LEAD PLATED (Continued)

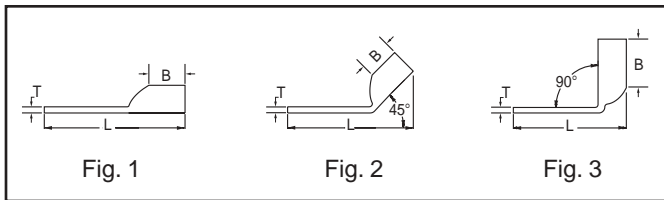

Catalog Number	Fig #	Conductor		Stud Hole Size	Stud Hole Spacing	Tongue Width	Figure Dimensions			▲ Installation Tooling					Wire Strip Length											
		AWG	*** MM ²				(B)	(T)	(L)	Dieless (# of crimps)	Mechanical MD6, OUR840, MD7-34R	Hydraulic BCT500HS, Y500CTHS	Y35, Y39, Y750, Y46*, PAT750	Color Code		Die Index										
YAG40L-2NNT-LD	1	646 kcmil	-	1/2"	1-3/4"	1.63"	1.42"	.30"	Y644M (1)	-	-	U39RT (2)	Black	24	1-5/16"											
YAG40L-2NNT-LD-45	2															5.43"										
YAG40L-2NNT-LD-90	3															5.42"										
YAG40L-2NTC-LD	1			1/2"	1-3/4"	1.98"	1.42"	.30"								5.43"										
YAG40L-2NTC-LD-45	2																5.42"									
YAG40L-2NTC-LD-90	3																3.91"									
YAG44L-2TC38-LD	1	777.7 kcmil	500	3/8"	1"	2.18"	1.65"	.33"	Y644M (1)	-	-	U44XRT (2)	Yellow	L115	1-5/8"											
YAG44L-2TC38-LD-45	2															4.80"										
YAG44L-2TC38-LD-90	3															4.75"										
YAG44L-2TC12-LD	1			1/2"	1-1/4"	2.18"	1.65"	.33"								5.11"										
YAG44L-2TC12-LD-45	2																5.07"									
YAG44L-2TC12-LD-90	3																3.33"									
YAG44L-2TC12E3-LD	1			1925/24	750 kcmil CLASS 1	1/2"	1-1/2"	2.18"								1.65"	.33"	Y644M (1)	-	-	U44XRT (2)	Yellow	L115	1-5/8"		
YAG44L-2TC12E3-LD-45	2																								5.36"	
YAG44L-2TC12E3-LD-90	3																								5.32"	
YAG44L-2TC12E3-LD	1					1/2"	1-3/4"	2.18"								1.65"	.33"								5.80"	
YAG44L-2NTC-LD-45	2																									5.75"
YAG44L-2NTC-LD-90	3																									3.58"
YAG44L-2TC58-LD	1	5/8"	1-1/2"	2.18"	1.65"	.33"	5.61"																			
YAG44L-2TC58-LD-45	2							5.57"																		
YAG44L-2TC58-LD-90	3							3.83"																		

C-77

* Use PUADP-1 adapter with "U" dies in Y46 HYPRESS™.
 *** The MM² conductor sizes listed are the recommendations for Class 5 conductor.

◆ For applications greater than 2000 Volts consult cable manufacturer for voltage stress relief instructions.