

KBL4005-G Thru. KBL410-G

Reverse Voltage: 50 to 1000V
 Forward Current: 4.0Amperes
 RoHS Device

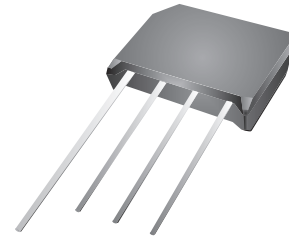

Features

- Surge overload rating -125 amperes peak.
- Ideal for printed circuit board.
- UL recognized file # E349301

Mechanical Data

- Epoxy: UL 94-V0 rate flame retardant.
- Case: Molded plastic, KBL
- Mounting position: Any
- Weight: 5.04 grams (approx.).

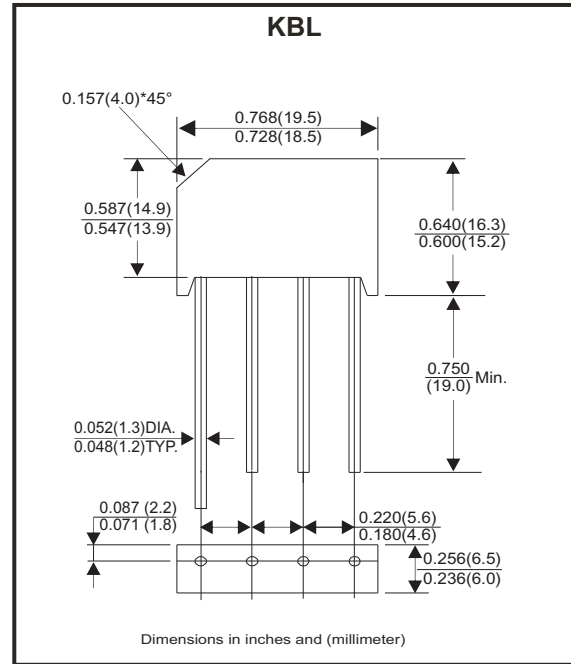

Maximum ratings and electrical characteristics

Rating at 25°C ambient temperature unless otherwise specified.
 Single phase, half wave ,60Hz, resistive or inductive load.
 For capacitive load, derate current by 20%

Parameter	Symbol	KBL 4005-G	KBL 401-G	KBL 402-G	KBL 404-G	KBL 406-G	KBL 408-G	KBL 410-G	Unit
Maximum Recurrent Peak Reverse Voltage	V _{RRM}	50	100	200	400	600	800	1000	V
Maximum RMS Bridge Input Voltage	V _{RMS}	35	70	140	280	420	560	700	V
Maximum DC Blocking Voltage	V _{DC}	50	100	200	400	600	800	1000	V
Maximum Average Forward Output Current at T _A =50°C (Note 1)	I _(AV)	4.0							A
Peak Forward Surge Current, 8.3ms Single Half Sine-Wave Super Imposed On Rated Load	I _{FSM}	125							A
Maximum Forward Voltage Drop Per Element at 4.0A Peak	V _F	1.1							V
Maximum DC Reverse Current at Rate DC Blocking Voltage	I _R	10.0							µA
Maximum Reverse Current at Rated DC Blocking Voltage and T _A =150°C	I _R	1.0							mA
Operating Temperature Range	T _J	-55 to +150							°C
Storage Temperature Range	T _{STG}	-55 to +150							°C

Notes:

1. Mounting conditions, 0.5" lead length maximum.

Company reserves the right to improve product design , functions and reliability without notice.

REV: C

Rating and Characteristics Curves (KBL4005-G Thru. KBL410-G)

Fig.1 - Derating Curve Output Rectified Current

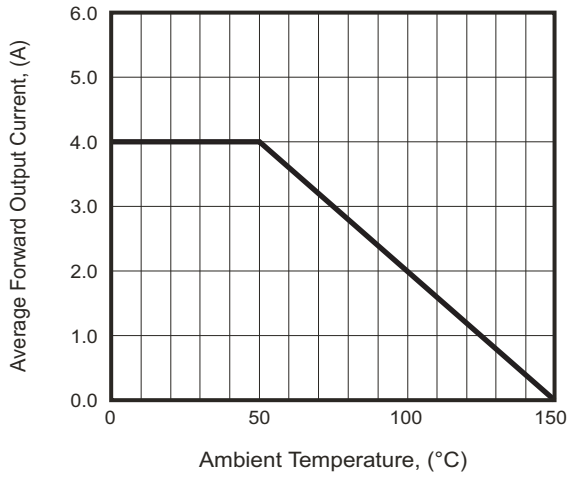

Fig.2 - Max. Forward Surge Current

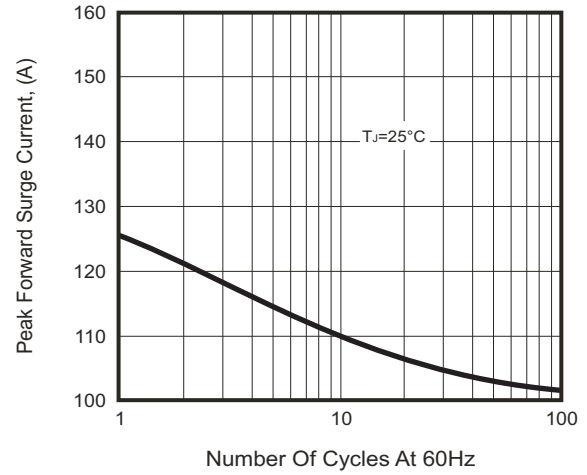

Fig.3 - Typical Forward Characteristics

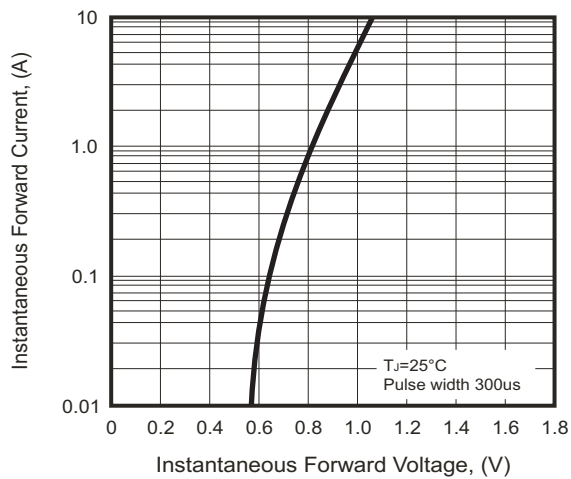
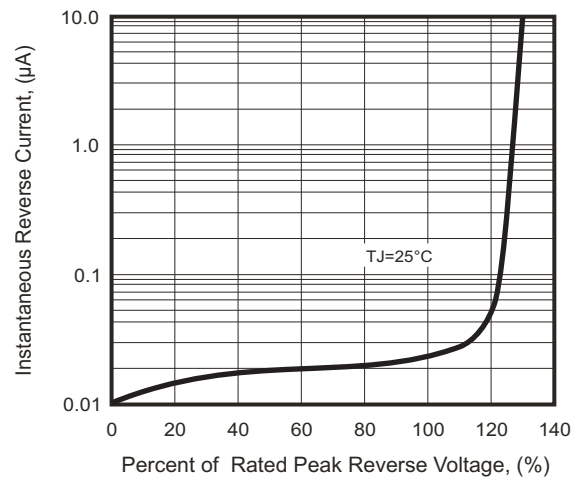
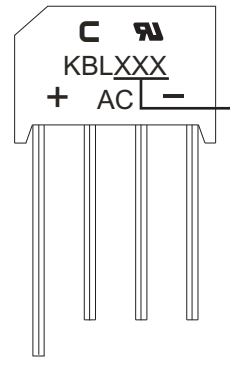

Fig.4 - Typical Reverse Characteristics



Marking Code

Part Number	Marking code
KBL4005-G	KBL005
KBL401-G	KBL01
KBL402-G	KBL02
KBL404-G	KBL04
KBL406-G	KBL06
KBL408-G	KBL08
KBL410-G	KBL10



XX / XXX = Product type marking code

C = Comchip Logo

Standard Packaging

Case Type	BULK PACK	
	BOX (pcs)	CARTON (pcs)
KBL	500	3,000